

Quick Reference

Learning about the printer

Using the printer control panel

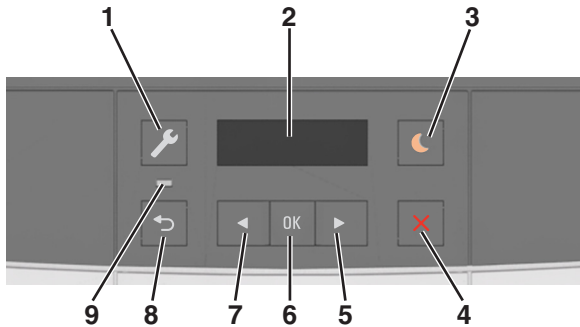

	Use the	To
1	Menu button	Open the menus. Notes: <ul style="list-style-type: none"> The menus are available only when the printer is in Ready state. Pressing the button while in a menu item lets you return to the top level menu screen.
2	Display	View printing options as well as status and error messages.
3	Sleep button	Enable Sleep mode or Hibernate mode. Notes: <ul style="list-style-type: none"> Pressing any hard button, sending a print job, or performing a power on reset with the main power switch wakes the printer from Sleep mode. Pressing the Sleep button or performing a power on reset with the main power switch wakes the printer from Hibernate mode.
4	Stop button	Stop printer activity.

	Use the	To
5	Right arrow button	<ul style="list-style-type: none"> Scroll through menus or move between screens and menu options. Increase the numeric value of an option or setting being displayed.
6	Select button	<ul style="list-style-type: none"> Select menu options. Save settings.
7	Left arrow button	<ul style="list-style-type: none"> Scroll through menus or move between screens and menu options. Decrease the numeric value of an option or setting being displayed.
8	Back button	Return to the previous screen.
9	Indicator light	Determine the status of the printer.

Understanding the colors of the indicator and Sleep button lights

The colors of the indicator and Sleep button lights on the printer control panel signify a certain printer status or condition.

Indicator light color and its corresponding printer status

Indicator light	Printer status
Off	The printer is off or in Hibernate mode.
Blinking green	The printer is warming up, processing data, or printing.
Solid green	The printer is on, but idle.
Blinking red	The printer requires user intervention.

Sleep button light color and its corresponding printer status

Sleep button light	Printer status
Off	The printer is idle or in Ready state.
Solid amber	The printer is in Sleep mode.
Blinking amber	The printer is waking from or entering Hibernate mode.

Sleep button light	Printer status
Blinking amber for 0.1 second, then goes completely off for 1.9 seconds in pulsing pattern	The printer is in Hibernate mode.

Using the Embedded Web Server

Note: This feature is available only in network printers or printers connected to print servers.

If the printer is installed on a network, then you can use the Embedded Web Server to do the following:

- View the virtual display of the printer control panel.
- Check the status of the printer supplies.
- Configure supply notifications.
- Configure printer settings.
- Configure network settings.
- View reports.

To access the Embedded Web Server for your printer:

- Obtain the printer IP address:
 - From the TCP/IP section in the Network/Ports menu
 - By printing a network setup page or menu settings page, and then finding the TCP/IP section

Notes:

 - An IP address appears as four sets of numbers separated by periods, such as 123.123.123.123.
 - If you are using a proxy server, then temporarily disable it to load the Web page correctly.
- Open a Web browser, and then type the printer IP address in the address field.
- Press **Enter**.
The Embedded Web Server page appears.

Loading paper and specialty media

Setting the paper size and type

- 1 From the printer control panel, navigate to:



- 2 Press the arrow buttons until **Tray [x] Size** or

Tray [x] Type appears, and then press **OK**.

- 3 Select a setting, and then press **OK**.

Configuring Universal paper settings

The Universal paper size is a user-defined setting that lets you print on paper sizes that are not preset in the printer menus.

Notes:

- The smallest supported Universal size is 76 x 127 mm (3 x 5 inches) and is loaded only in the multipurpose feeder and manual feeder.
- The largest supported Universal size is 215.9 x 359.9 mm (8.5 x 14.17 inches) and is loaded only in the multipurpose feeder and manual feeder.

- 1 From the printer control panel, navigate to:



- 2 Press the arrow buttons until **Units of Measure, Portrait**

Height, or **Portrait Width** appears, and then press **OK**.

- 3 Select a setting, and then press **OK**.

Loading the 250-sheet tray

The printer has one standard 250-sheet tray (Tray 1) with an integrated manual feeder. The 250-sheet tray and the optional 650-sheet duo tray with an integrated multipurpose feeder support the same paper sizes and types and are loaded in the same way.

- 1 Pull out the tray completely.

Note: Do not remove trays while a job is printing or while **Busy** appears on the display. Doing so may cause a jam.



- 2 Squeeze, and then slide the width guide tab to the correct position for the paper you are loading.

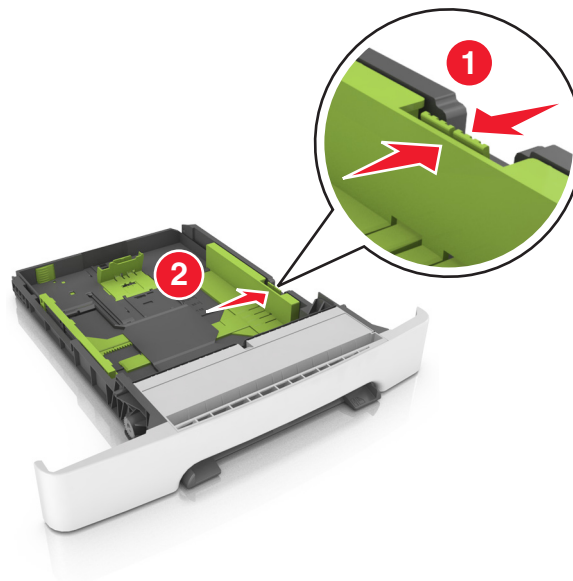

- 3 Squeeze, and then slide the length guide tab to the correct position for the paper you are loading.

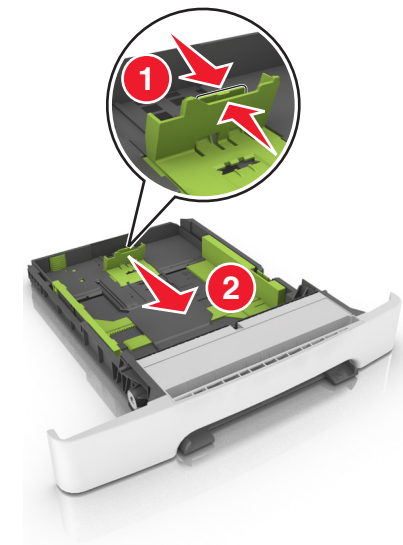

Notes:

- Use the paper size indicators on the bottom of the tray to help position the guides.
- If the paper is longer than letter-size paper, then push the length guide and the length guide tab to extend it.

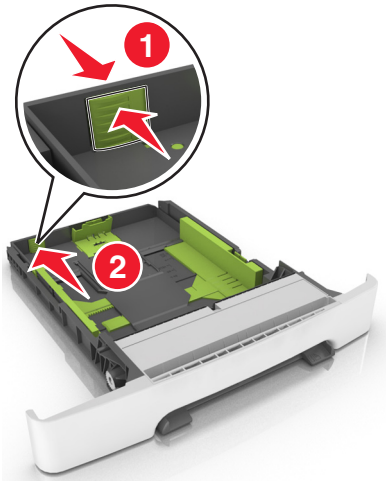

4 Flex the sheets back and forth to loosen them. Do not fold or crease the paper. Straighten the edges on a level surface.

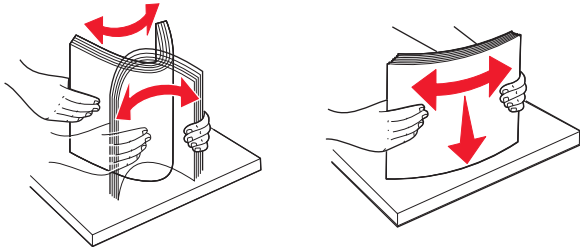

5 Load the paper stack with the recommended printable side faceup.

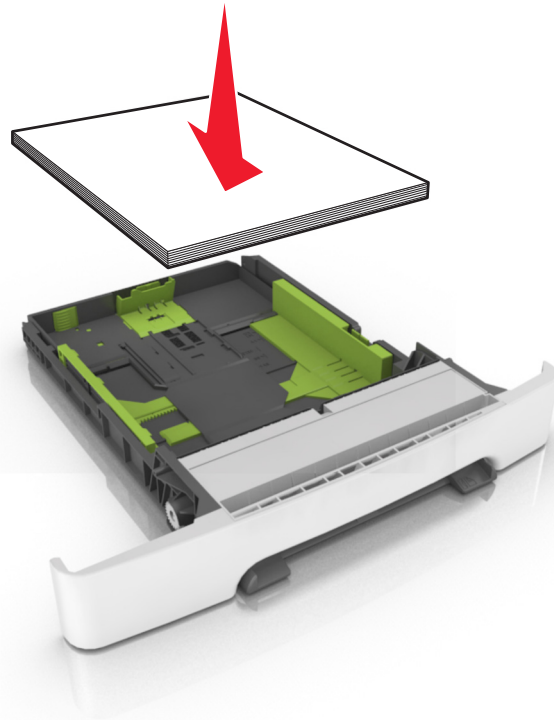

6 Insert the tray.



7 From the printer control panel, set the paper size and type in the Paper menu to match the paper loaded in the tray.

Note: Set the correct paper size and paper type to avoid paper jams and print quality problems.

Loading the 650-sheet duo tray

The 650-sheet duo tray (Tray 2) consists of a 550-sheet tray and an integrated 100-sheet multipurpose feeder. The tray is loaded in the same way as the 250-sheet tray and the optional 550-sheet tray, and supports the same paper types and sizes. The only differences are the look of the guide tabs and the location of the paper size indicators.

CAUTION—POTENTIAL INJURY: To reduce the risk of equipment instability, load each tray separately. Keep all other trays closed until needed.

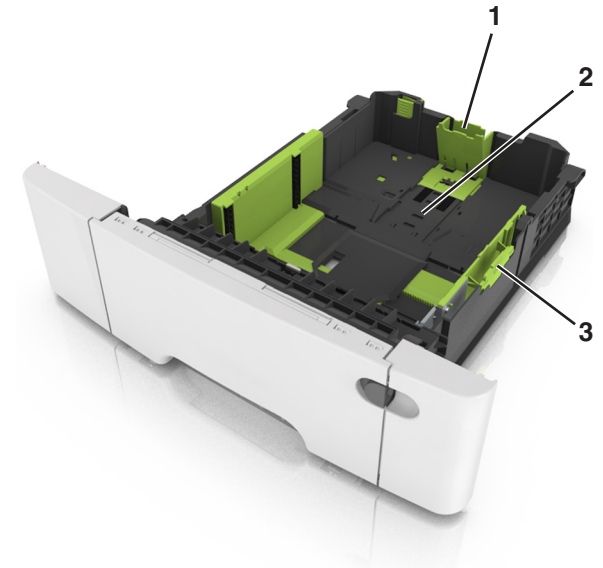

1	Length guide tab
2	Paper size indicator
3	Width guide tab

Loading the multipurpose feeder

- 1 Push the multipurpose feeder latch to the left.



- 2 Open the multipurpose feeder.



- 3 Pull the multipurpose feeder extender.

Note: Guide the extender gently so that the multipurpose feeder is fully extended and open.



- 4 Prepare the paper for loading.

- Flex sheets of paper back and forth to loosen them. Do not fold or crease the paper. Straighten the edges on a level surface.

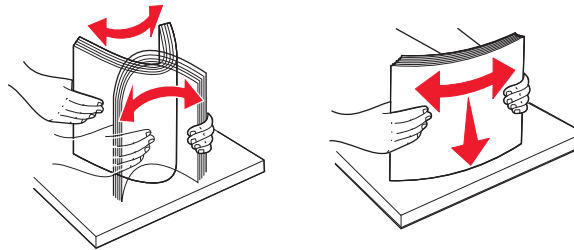

- Hold transparencies by the edges. Straighten the edges on a level surface.

Note: Avoid touching the printable side of transparencies. Be careful not to scratch them.

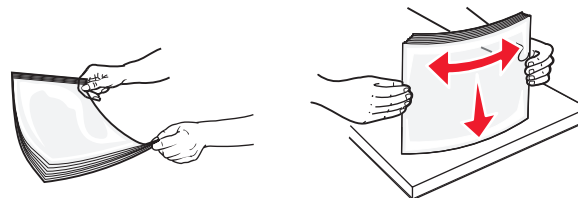

- Flex a stack of envelopes back and forth to loosen them. Straighten the edges on a level surface.

Warning—Potential Damage: Never use envelopes with stamps, clasps, snaps, windows, coated linings, or self-stick adhesives. These envelopes may severely damage the printer.

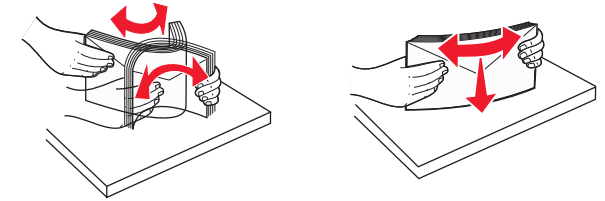

- 5 Locate the maximum paper fill indicator and tab.

Note: Make sure the paper or specialty media is below the maximum paper fill indicator located on the paper guides.

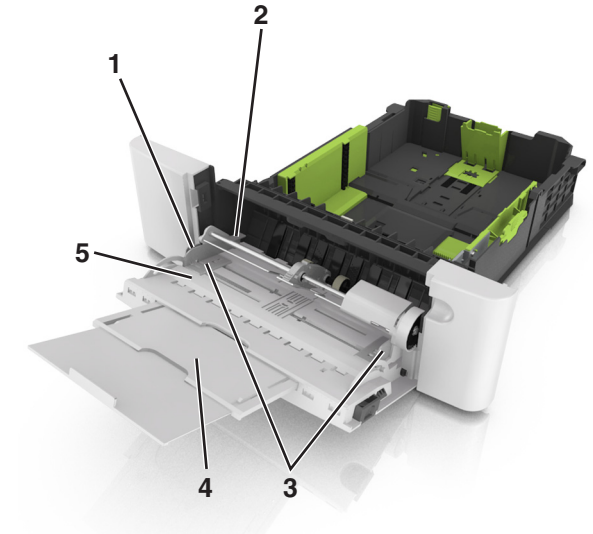

1	Width guide tab
2	Maximum paper fill indicator
3	Width guide
4	Feeder extender
5	Paper size indicator

- 6 Load the paper, and then adjust the width guide to lightly touch the edge of the paper stack.
- Load paper, card stock, and transparencies with the recommended printable side facedown and the top edge entering first.



- Load envelopes with the flap side up and against the right side of the paper guide.

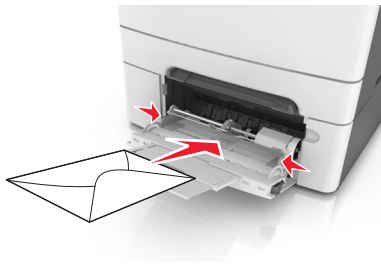

Notes:

- Do not load or close the multipurpose feeder while a job is printing.
- Load only one size and type of paper at a time.
- Paper should lie flat in the multipurpose feeder. Make sure the paper fits loosely in the multipurpose feeder and is not bent or wrinkled.

- 7 From the printer control panel, set the paper size and type in the Paper menu to match the paper loaded in the tray.

Loading the manual feeder

The standard 250-sheet tray has an integrated manual feeder that can be used to print on different types of paper one sheet at a time.

- 1 Load a sheet of paper into the manual feeder:

- Printable side facedown for one-sided printing
- Printable side faceup for two-sided (duplex) printing

Note: There are different ways for loading letterhead depending on the mode of printing.

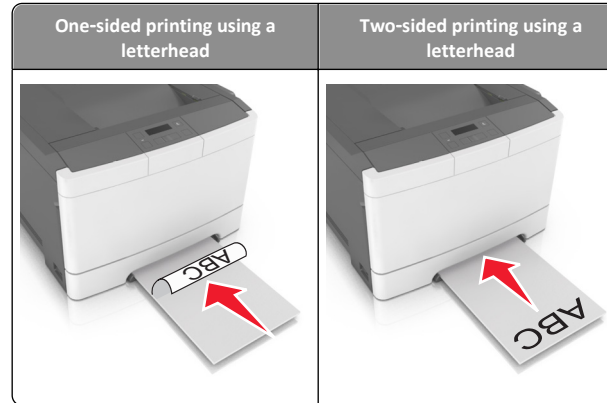

- Load envelope with the flap side up and against the right side of the paper guide.



- 2 Feed paper into the manual feeder only to the point where its leading edge can contact the paper guides.

Note: To achieve the best possible print quality, use only high-quality media designed for laser printers.

- 3 Adjust the paper guides to the width of the paper loaded.

Warning—Potential Damage: Do not force the paper into the feeder. Forcing the paper may cause jams.

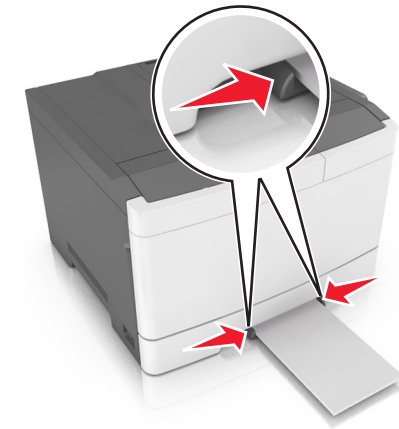

Linking and unlinking trays

When the paper size and paper type for any trays are the same, the printer will link those trays. When one linked tray becomes empty, paper will feed from the next linked tray. We recommend giving all unique paper, such as letterhead and different colored plain papers, a different custom type name so that the trays they are in will not automatically link.

Linking and unlinking trays

Note: This feature applies only in network printers.

- 1 Open a Web browser, and then type the printer IP address in the address field.

Notes:

- View the printer IP address in the TCP/IP section in the Network/Ports menu. The IP address appears as four sets of numbers separated by periods, such as 123.123.123.123.
- If you are using a proxy server, then temporarily disable it to load the Web page correctly.

- 2 Click **Settings > Paper Menu**.

- 3 Change the tray settings to specify the paper size and type for the tray.

- To link trays, make sure the paper size and type for the tray match with that of the other tray.
- To unlink trays, make sure the paper size or type for the tray *does not* match with that of the other tray.

4 Click **Submit**.

Warning—Potential Damage: Paper loaded in the tray should match the paper type name assigned in the printer. The temperature of the fuser varies according to the specified paper type. Printing issues may occur if settings are not properly configured.

Creating a custom name for a paper type

Assigning a Custom Type [x] name to a tray enables you to link or unlink the tray to another tray. Use the same Custom Type [x] name for each tray that you want to link.

Using the Embedded Web Server

- 1 Open a Web browser, and then type the printer IP address in the address field.

Notes:

- View the printer IP address in the TCP/IP section in the Network/Ports menu. The IP address appears as four sets of numbers separated by periods, such as 123.123.123.123.
- If you are using a proxy server, then temporarily disable it to load the Web page correctly.

- 2 Navigate to:

Settings > Paper Menu > Custom Names > type a name > Submit

Note: The custom name will replace Custom Type [x] under the “Custom Types” and “Paper Size and Type” menus.

- 3 Navigate to:

Custom Types > select a paper type > Submit

Assigning a custom paper type name

Assign a custom paper type name to a tray when linking or unlinking trays.

Using the Embedded Web Server

- 1 Open a Web browser, and then type the printer IP address in the address field.

Notes:

- View the printer IP address in the TCP/IP section in the Network/Ports menu. The IP address appears as four sets of numbers separated by periods, such as 123.123.123.123.
- If you are using a proxy server, then temporarily disable it to load the Web page correctly.

- 2 Click **Settings > Paper Menu > Custom Name**.

- 3 Type a name for the paper type, and then click **Submit**.

- 4 Select a custom type, and then verify that the correct paper type is associated with the custom name.

Note: Plain Paper is the factory default paper type for all user-defined custom names.

Configuring a custom name

- 1 Open a Web browser, and then type the printer IP address in the address field.

Notes:

- View the printer IP address in the TCP/IP section in the Network/Ports menu. The IP address appears as four sets of numbers separated by periods, such as 123.123.123.123.
- If you are using a proxy server, then temporarily disable it to load the Web page correctly.

- 2 Click **Settings > Paper Menu > Custom Types**.

- 3 Select the custom name you want to configure, then select a paper or specialty media type, and then click **Submit**.

Printing

Printing a document

- 1 From the Paper menu on the printer control panel, set the paper type and size to match the paper loaded.
- 2 Send the print job:

For Windows users

- a With a document open, click **File > Print**.
- b Click **Properties, Preferences, Options, or Setup**.
- c Adjust the settings, if necessary.
- d Click **OK > Print**.

For Macintosh users

- a Customize the settings in the Page Setup dialog:
 - 1 With a document open, choose **File > Page Setup**.
 - 2 Choose a paper size or create a custom size to match the paper loaded.
 - 3 Click **OK**.
- b Customize the settings in the Print dialog:

- 1 With a document open, choose **File > Print**.
If necessary, click the disclosure triangle to see more options.
- 2 From the Print dialog and pop-up menus, adjust the settings if necessary.
Note: To print on a specific paper type, adjust the paper type setting to match the paper loaded, or select the appropriate tray or feeder.
- 3 Click **Print**.

Printing in black and white

From the printer control panel, navigate to:



Adjusting toner darkness

Using the Embedded Web Server

- 1 Open a Web browser, and then type the printer IP address in the address field.

Notes:

- View the printer IP address in the TCP/IP section in the Network/Ports menu. The IP address appears as four sets of numbers separated by periods, such as 123.123.123.123.
- If you are using a proxy server, then temporarily disable it to load the Web page correctly.

- 2 Click **Settings > Print Settings > Quality Menu > Toner Darkness**.
- 3 Adjust the toner darkness, and then click **Submit**.

Using the printer control panel

- 1 From the printer control panel, navigate to:



- 2 Set the toner darkness, and then press **OK**.

Using Max Speed and Max Yield

Max Speed and Max Yield let you choose between a faster print speed and a higher toner yield.

- **Max Speed**—This lets you print in either black or color depending on what is set in the printer driver. The printer prints in color unless Black Only is selected in the printer driver.
- **Max Yield**—This lets you switch from black to color based on the color content found on each page. This is the factory default setting. Frequent color mode switching can result to slower printing if the content of pages is mixed.

Using the Embedded Web Server

- 1 Open a Web browser, and then type the printer IP address in the address field.

Notes:

- View the printer IP address in the TCP/IP section in the Network/Ports menu. The IP address appears as four sets of numbers separated by periods, such as 123.123.123.123.
- If you are using a proxy server, then temporarily disable it to load the Web page correctly.

- 2 Click **Settings > Print Settings > Setup Menu**.
- 3 From the Printer Usage list, select **Max Speed** or **Max Yield**.
- 4 Click **Submit**.

Using the printer control panel



- 1 From the printer control panel, navigate to:



- 2 From the Printer Usage list, select **Max Speed** or **Max Yield**.
- 3 Press **OK**.

Canceling a print job

Canceling a print job from the printer control panel

From the printer control panel, press  > .

Canceling a print job from the computer

For Windows users

- 1 Open the printers folder.
 - a Click , or click **Start** and then click **Run**.
 - b In the Start Search or Run dialog, type **control printers**.
 - c Press **Enter**, or click **OK**.
- 2 Double-click the printer icon.
- 3 Select the print job you want to cancel.
- 4 Click **Delete**.

For Macintosh users

- 1 From the Apple Menu, navigate to either of the following:
 - **System Preferences > Print & Scan > select a printer > Open Print Queue**
 - **System Preferences > Print & Fax > select a printer > Open Print Queue**
- 2 From the printer window, select the print job you want to cancel, and then click **Delete**.

Clearing jams

Avoiding jams

Load paper properly

- Make sure paper lies flat in the tray.

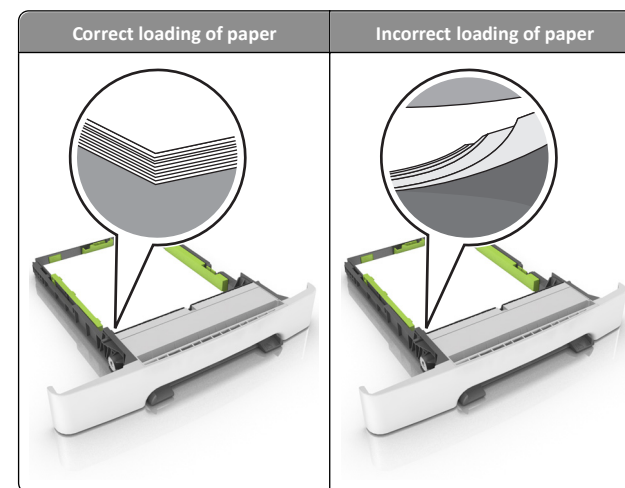

- Do not remove a tray while the printer is printing.
- Do not load a tray while the printer is printing. Load it before printing, or wait for a prompt to load it.
- Do not load too much paper. Make sure the stack height is below the maximum paper fill indicator.

- Do not slide the paper into the tray. Load paper as shown in the illustration.

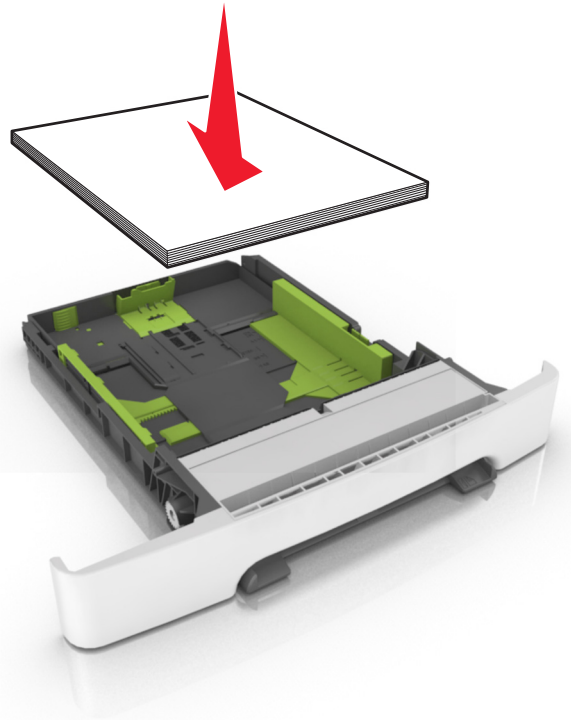

- Make sure the guides in the tray or the multipurpose feeder are properly positioned and are not pressing tightly against the paper or envelopes.
- Push the tray firmly into the printer after loading paper.

Use recommended paper

- Use only recommended paper or specialty media.
- Do not load wrinkled, creased, damp, bent, or curled paper.

- Flex and straighten paper before loading it.

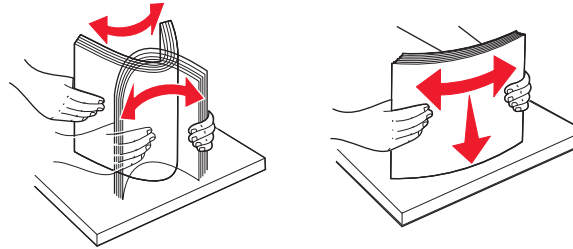

- Do not use paper that has been cut or trimmed by hand.
- Do not mix paper sizes, weights, or types in the same tray.
- Make sure the paper size and type are set correctly on the computer or printer control panel.
- Store paper per manufacturer recommendations.

Understanding jam messages and locations

When a jam occurs, a message indicating the jam location and information to clear the jam appears on the printer display. Open the doors, covers, and trays indicated on the display to remove the jam.

Note: When Jam Recovery is set to On or Auto, the printer reprints jammed pages. However, Auto does not guarantee that the page will print.

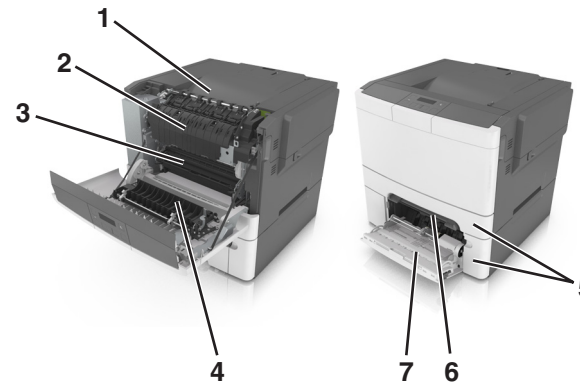

	Jam location	Message on the display	What to do
1	Standard bin	[x]-page jam, clear standard bin. [203.xx]	Remove the jammed paper.
2	Fuser	[x]-page jam, open front door to clear fuser. [202.xx]	Open the front door, pull the tab and hold the fuser cover down, and then remove the jammed paper.
3	Front door	[x]-page jam, open front door. [20y.xx]	Open the front door, and then remove the jammed paper.
4	Duplex	[x]-page jam, open front door to clear duplex. [23y.xx]	Open the front door, and then remove the jammed paper.
5	Tray [x]	[x]-page jam, open tray [x]. [24y.xx]	Pull the indicated tray out, and then remove the jammed paper.
6	Manual feeder	[x]-page jam, clear manual feeder. [251.xx]	Remove the jammed paper.
7	Multipurpose feeder	[x]-page jam, clear multipurpose feeder. [250.xx]	Push the paper release lever to lift the paper rollers, and then remove the jammed paper.

[x]-page jam, clear manual feeder. [251.xx]

- 1 Pull out the standard 250-sheet tray (Tray 1) and manual feeder.



- 2 Firmly grasp the jammed paper on each side, and then gently pull it out.

Note: Make sure all paper fragments are removed.



- 3 Insert the tray.

- 4 From the printer control panel, press **OK** to clear the message and continue printing.

[x]-page jam, clear multipurpose feeder. [250.xx]

- 1 Push the paper release lever in the multipurpose feeder to access the jammed paper, and then gently pull it out.

Note: Make sure all paper fragments are removed.



- 2 Flex the sheets of paper back and forth to loosen them. Do not fold or crease the paper. Straighten the edges on a level surface.

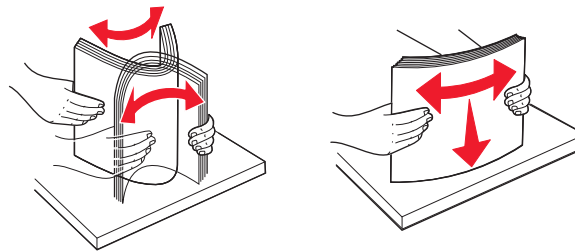

- 3 Reload paper into the multipurpose feeder.



- Slide the paper guide until it lightly rests against the edge of the paper stack.



- From the printer control panel, press **OK** to clear the message and continue printing.

[x]-page jam, clear standard bin. [203.xx]

- Firmly grasp the jammed paper on each side, and then gently pull it out.

Note: Make sure all paper fragments are removed.

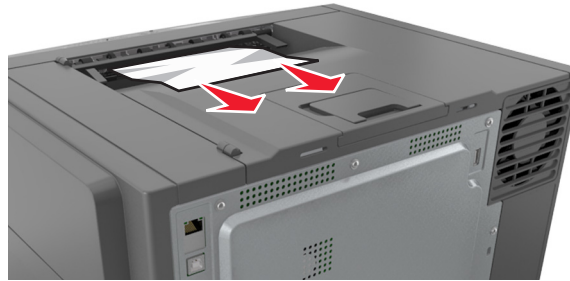

- From the printer control panel, press **OK** to clear the message and continue printing.

[x]-page jam, open front door. [20y.xx]

- Open the front door.

 **CAUTION—HOT SURFACE:** The inside of the printer might be hot. To reduce the risk of injury from a hot component, allow the surface to cool before touching it.

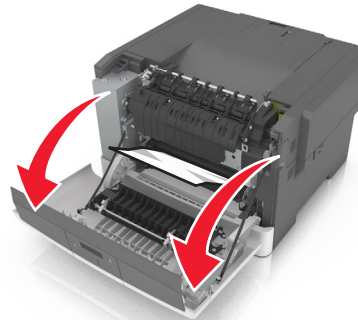

- Firmly grasp the jammed paper on each side, and then gently pull it out.

Note: Make sure all paper fragments are removed.

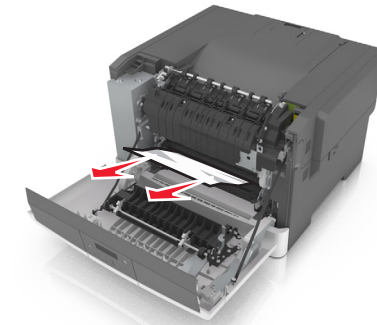

- Close the front door.

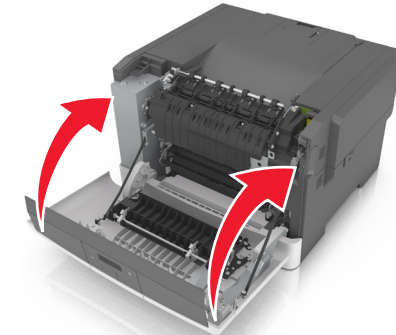

- From the printer control panel, press **OK** to clear the message and continue printing.

[x]-page jam, open front door to clear duplex. [23y.xx]

- Open the front door.

 **CAUTION—HOT SURFACE:** The inside of the printer might be hot. To reduce the risk of injury from a hot component, allow the surface to cool before touching it.

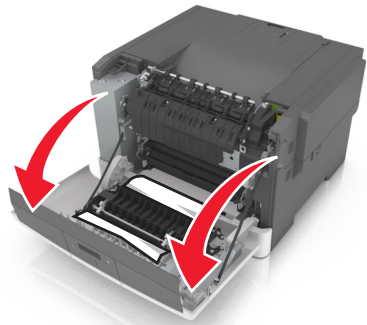

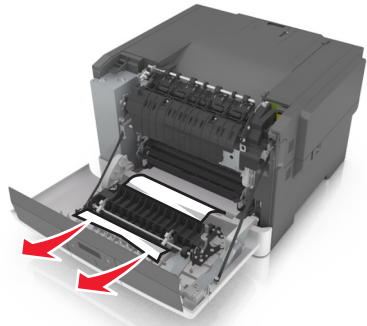

2 Firmly grasp the jammed paper on each side, and then gently pull it out.

Note: Make sure all paper fragments are removed.

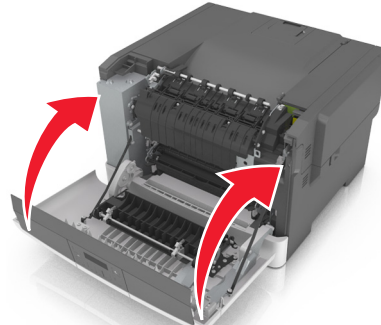

3 Close the front door.



4 From the printer control panel, press  to clear the message and continue printing.

[x]-page jam, open front door to clear fuser. [202.xx]

1 Open the front door.

 **CAUTION—HOT SURFACE:** The inside of the printer might be hot. To reduce the risk of injury from a hot component, allow the surface to cool before touching it.

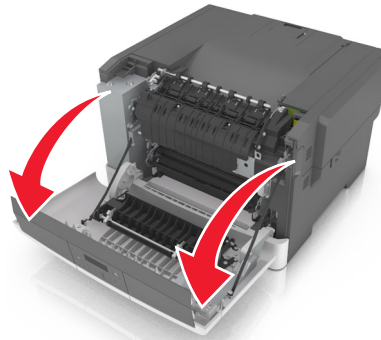

2 Pull the green lever to open the fuser cover.



3 Hold down the fuser cover, and then remove the jammed paper.

Note: Make sure all paper fragments are removed.

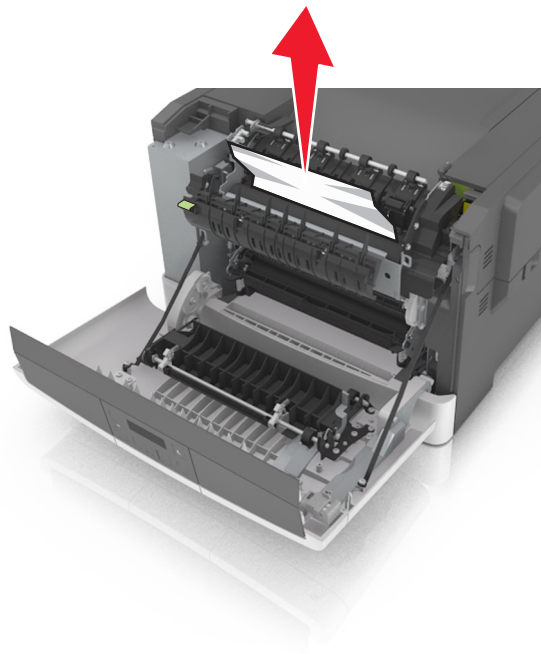

4 Close the front door.

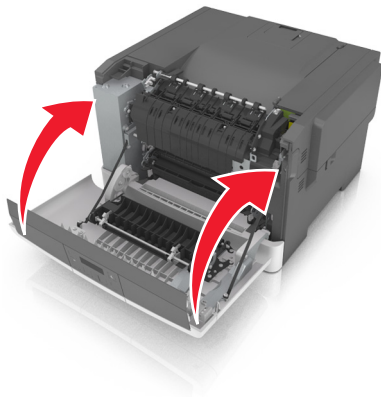

5 From the printer control panel, press **OK** to clear the message and continue printing.

[x]-page jam, open tray [x] [24y.xx]

1 Pull the tray out completely.

Note: The message on the printer display determines in which tray the paper jam is located.

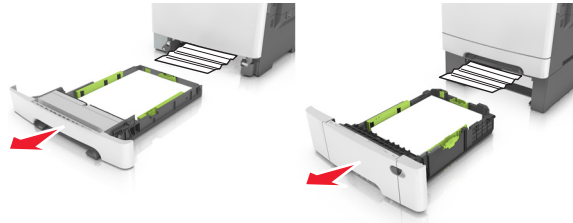

2 Firmly grasp the jammed paper on each side, and then gently pull it out.

Note: Make sure all paper fragments are removed.



3 Insert the tray.

4 From the printer control panel, press **OK** to clear the message and continue printing.