



NetCloud Services for Mobile



COR IBR900 Series Spec Sheet



Shown: COR IBR900-1200M-B

Cradlepoint COR IBR900 Series mobile routers are sold as part of an all-inclusive mobile networking package.

NetCloud Mobile Packages include:

- Ruggedized endpoints, purpose-built for mobile applications
- A NetCloud Service Plan tailored for mobile networking and set for a specific term
- 24x7 support and limited lifetime warranty

What to Buy

Description	Part Numbers
North America (U.S., Canada)	
— NetCloud Mobile Essentials Package with IBR900-1200M-B-NPS	MAx-0900120B-NNA
— NetCloud Mobile Essentials Package with IBR900-1200M-NPS	MAx-09001200-NNA
— NetCloud Mobile Essentials Package with IBR900-600M-NPS	MAx-0900600M-NNA
— NetCloud Mobile Essentials Package with IBR900	MAx-0900NM-0NA
Europe (EU)	
— NetCloud Mobile Essentials Package with IBR900-600M-EU-NPS	MAx-0900600M-EWA
— NetCloud Mobile Essentials Package with IBR900-EU	MAx-0900NM-0WA
Asia-Pacific (Australia, New Zealand, Singapore)	
— NetCloud Mobile Essentials Package with IBR900-600M-AP-NPS	MAx-0900600M-PWA
— NetCloud Mobile Essentials Package with IBR900LP5-NPS-AP	MAx-0900LP5-PWA
— NetCloud Mobile Essentials Package with IBR900-AP	MAx-0900NM-0WA
All Regions	
— NetCloud Mobile Advanced Plan	MAx-NCADV

x = 1, 3, or 5 years

NetCloud Mobile Essentials packages and plans contain all the features and capabilities required for a broad range of mobile or in-vehicle applications. Essentials packages include 24x7 support (phone support: 24 hour weekdays with emergency response on weekends, web: 24x7, chat: 24x5) and a limited lifetime warranty.

For additional capabilities, a **NetCloud Mobile Advanced Plan** can be added to the NetCloud Mobile Essentials Package at any time.

See additional details of what is included in the Essential and Advanced NetCloud software: cradlepoint.com/netcloud-manager

For more details on the COR IBR900 mobile router, included with the NetCloud Mobile Packages, see below.

What's in the Box

- Ruggedized high-performance router with embedded, business-class LTE modem; includes integrated mounting plate
- A 4-wire power/GPIO cable (3 meters)
- Two (2) extra SIM door screws
- Safety, Regulatory, and Warranty Guide

Models

- COR IBR900-1200M-B: LTE Advanced Pro 1 Gbps LTE/HSPA+ with SIM-based, auto carrier Selection
 - FirstNet® Ready (includes support for Band 14)
- COR IBR900-1200M: LTE Advanced Pro 1 Gbps LTE/HSPA+ (With SIM-based, auto carrier selection for AT&T/FirstNet® and Verizon)
 - FirstNet Ready (includes support for Band 14)
- COR IBR900-600M: LTE Advanced 600 Mbps LTE/HSPA+ (SIM-based, auto-carrier selection for all North American, European, and Asia Pacific carriers; includes support for 700 MHz Band 28 in Asia Pacific)
 - FirstNet Ready (does not support Band 14)
- COR IBR900LP6: LTE Advanced 600 Mbps LTE/HSPA+ (SIM-based, auto-carrier selection for all North American, European, and Asia Pacific carriers; includes support for 700 MHz Band 28 in Asia Pacific)
 - FirstNet Ready (does not support Band 14)
- COR IBR900LP5: 300 Mbps LTE Advanced for operators in Asia Pacific and Saudi Arabia (SIM-based, auto carrier selection)

Key Features

WAN

- Dual-modem capable with optional COR Extensibility Dock
- WiFi-as-WAN, with WPA2 Enterprise Authentication for WiFi-as-WAN
- Failover/Failback
- Load Balancing
- Advanced Modem Failure Check
- WAN Port Speed Control
- WAN/LAN Traffic Steering
- IP Passthrough
- Standby
- DynDNS
- QoS (DSCP and Priority Queuing)

LAN

- VLAN 802.1Q
- DHCP Server, Client, Relay²
- DNS and DNS Proxy
- UPnP
- DMZ
- Multicast/Multicast Proxy
- MAC Address Filtering

WiFi¹

- Dual-Band, dual-concurrent
- 802.11 a/b/g/n/ac wave 2—MU-MIMO and 256 QAM support
- Multiple SSIDs: 2 per radio (4 total)
- WPA2 Enterprise (WiFi)
- Hotspot/Captive Portal
- SSID-based Priority
- Client Mode for faster data offload
- Frequencies supported:
 - 2.4 GHz (2412 – 2472 MHz)
 - 5 GHz
 - U-NII-1 (5.150-5.250 GHz)
 - U-NII- 2a (5.250-5.350 GHz) North America IBR900-600M Only
 - U-NII-2c (5.470-5.725 GHz) North America IBR900-600M Only
 - U-NII-3 (5.7225-5.825 MHz) North America Only

Management

- Cradlepoint NetCloud Manager
- Web UI, API, CLI
- Active GPS support on all models
- Data Usage Alerts (router and per client)
- Advanced Troubleshooting (support)
- Device Alerts
- SNMP
- SMS control
- Serial Redirector
- Auto APN Recovery
- Syslog

VPN & Routing

- IPsec Tunnel – up to ten concurrent sessions
- L2TP
- GRE Tunnel
- OSPF/BGP/RIP
- Route Filters (Access Control Lists, Prefix Filters, Route Maps, Communities for BGP)
- Per-Interface Routing
- Routing Rules
- Policy-based Routing
- NAT-less Routing
- Virtual Server/Port Forwarding
- NEMO/DMNR
- IPv6
- VRRP
- STP
- NHRP
- VTI Tunnel support
- OpenVPN support
- CP Secure VPN compatible
- Serial PAD Mode

Security

- RADIUS and TACACS+ support*
- 802.1x authentication for Ethernet**
- Zscaler integration
- Certificate support
- ALGs
- MAC Address Filtering
- Advanced Security Mode (local user management only)
- FIPS 140-2 Inside version available
- Per-Client Web Filtering
- IP Filtering
- Content Filtering (basic)
- Website Filtering
- Zone-Based Object Firewall with host address (IP or FQDN), port, and MAC address

*Native support for authentication. Authorization and accounting support through hotspot/captive portal services.

**802.1x Authentication for Ethernet not available for FIPS SKUs.

Cloud Optimized IP Communications

- Automated WAN Failover/Failback support
- WAN Affinity and QoS allow prioritization of VoIP services
- Advanced VPN connectivity options to HQ
- SIP ALG and NAT to allow VoIP and UC communications to traverse firewall
- MAC Address Filtering
- 802.1p/q for LAN QoS segmentation and treatment of VoIP on LAN
- Private Network support (wired and 4G WAN)
- Cloud-based management

IoT Connector

- NetCloud Edge Connector for Microsoft® Azure IoT Central

1 — WiFi-related functions are only supported on IBR900 models

2 — DHCP Relay across a wide area network (WAN) only available on the LP3 and LP5 models. All other models require a VPN tunnel present for DHCP Relay to function properly.

Specifications

The following features are delivered through the hardware.

WAN:

- Dual-modem capable with optional COR Extensibility Dock
- Embedded 1200M LTE Advanced Pro modem (with DC-HSPA+ failover), delivering 1 Gbps**
- Embedded 600M LTE Advanced 600 Mbps modem (with DC-HSPA+ failover)
- Two LAN/WAN switchable 10/100/1000 Gigabit Ethernet ports – one default WAN (cable/DSL/T1/satellite/Metro Ethernet)
- WiFi-as-WAN, Metro WiFi; 2x2 MIMO “N” 2.4 GHz or 5 GHz; 802.11 a/b/g/n/ac wave 2 (IBR900 only)

LAN:

- Dual-band, dual-concurrent WiFi; 802.11 a/b/g/n/ac wave 2 (IBR900 only)
- Two LAN/WAN switchable 10/100/1000 Gigabit Ethernet ports – one default LAN
- Serial console support for Out-of-Band Management of a connected device

Ports:

- 4-Wire power/GPIO
- Add more GPIO ports with optional 9-wire power/GPIO cable or COR Extensibility Dock with 2x10-wire power/GPIO cable
- USB 2.0
- Two Ethernet LAN/WAN

- Two cellular antenna connectors (SMA)
- One active GPS antenna connector (SMA)
- Two WiFi antenna connectors (RP-SMA)
- 15-pin dock port for COR Extensibility Dock, 9-wire GPIO cable, or COR Extensibility Port to Serial Cable

Temperature:

- -30 °C to 70 °C (-22 °F to 158 °F) operating with optional* 9-wire power and GPIO cable (Part #170680-000)
- -30 °C to 70 °C (-22 °F to 158 °F) operating with optional extended temperature AC power supply (Part #170648-000; see this page for line cord details)
- -20 °C to 60 °C (-4 °F to 140 °F) operating with included† standard AC power supply
- -40 °C to 85 °C (-40 °F to 185 °F) storage

* Included with “-NPS” version, † - not included with “-NPS” version

Humidity (non-condensing):

- 5% to 95% operating
- 5% to 95% storage

Power:

- DC input steady state voltage range: 9–33 VDC (requires in-line fuse for vehicle installations)
 - For 9–24 VDC installations, use a 3 A fuse
 - For > 24 VDC installations, use a 2.5 A fuse
- Reverse polarity and transient voltage protection per ISO 7637-2
- Ignition sensing (automatic ON and time-delay OFF)
- Power consumption:
 - Idle: 4W
 - LTE Tx/Tx: 6.25W
 - WiFi Tx/Rx: 9W
 - 12 VDC / 2 A adapter recommended

WiFi Power:

- 2.4 GHz: 18 dBm conducted
- 5 GHz VHT20: 17.5 dBm conducted
- 5 GHz VHT40: 17 dBm conducted
- 5 GHz VHT80: 16.5 dBm conducted

Size: 4.6 × 4.5 × 1.2 in (118 × 113.5 × 29.3 mm)

Weight: 14 oz (400 g)

Certifications:

- WiFi Alliance (IBR900 only) – 802.11a/b/g/n/ac wave 2 certified
- Safety: UL/CUL, CB Scheme, EN60950-1
- Hazardous Locations: Class1, Div 2. IBR900-600M-NA only.
- Shock/Vibration/Humidity: Compliant with MIL STD 810G and SAEJ1455
- Ingress Protection: Compliant with IP54 (includes protection from dust and splashing water)
- Materials: WEEE, RoHS, RoHS-2, California Prop 65
- Telecom: PTCRB/CTIA, GCF-CC
- Regulatory Models: S5A643A, S5A644A, S5A648A, S5A701A, S5A706A, S5A843A, S5A848A
- FIPS 140-2 Inside

GPS:

- GPS Protocols: TAIP and NMEA 0183 V3.0
- Satellite channels: Maximum 55 channels, simultaneous tracking
- Concurrent standalone GPS, GLONASS, BeiDou and Galileo
- 1 Hz refresh rate
- Accuracy:
 - < 2 m: 50%
 - < 5 m: 90%
 - Horizontal: < 2 m (50%); < 5 m (90%)
 - Altitude: < 4 m (50%); < 8 m (90%)
 - Velocity: < 0.2 m/s
- Acquisition (measured with signal strength = -145 dBm):
 - Hot start: 1 second
 - Warm start: 29 seconds
 - Cold start: 32 seconds
- Sensitivity:
 - Tracking: -160 dBm (tracking sensitivity is the lowest GNSS signal level for which the device can still detect an in-view satellite 50% of the time when in sequential tracking mode)
 - Acquisition (standalone): -145 dBm (acquisition sensitivity is the lowest GNSS signal level for which the device can still detect an in-view satellite 50% of the time)
- Operational limits: Altitude < 6000 m or velocity < 100 m/s (either limit may be exceeded, but not both)

Router Performance

- Max Throughput (Default Configuration*): 940 Mbps
- Max Concurrent TCP Sessions: 16,000
- Recommended Max Client Count: 10**

Performance testing was conducted based off requirements as defined in RFC2544 using a mix of 64, 256, and 1500-byte packet sizes. Throughput is shown as bi-directional TCP traffic with less than a 1% packet loss using four wired clients.

Specifications and information in this datasheet are subject to change without notice.

*Cradlepoint defines client as any network connected device utilizing resources, such as bandwidth, on the local network.

**If CP Secure Threat Management or Application Analytics are enabled, the recommended max client count is 5.

Accessories

The IBR900 series mobile router do not include antennas and, therefore, requires the following accessories for optimal performance:

Required Accessories

- 3G/4G LTE cellular antennas (Qty. 2)
 - Recommended for bench test: 170760-000: Black, Universal 600MHz-6GHz 3G/4G/LTE 2dBi/3dBi 6" antenna with SMA connector (1x)
- 2.4/5GHz Dual Band WiFi antennas (Qty. 2)
 - Recommended for bench test: 170628-000 Dual-band 2.4/5.0 GHz external WiFi antenna
- An active (powered) GPS antenna
 - Recommended for bench test: 170760-000: Black, Universal 600MHz-6GHz 3G/4G/LTE 2dBi/3dBi 6" antenna with SMA connector (1x)

Additional Cradlepoint accessory options for extensibility, power, and antennas include:

Second Integrated LTE Modem with MC400:

- MC400-1200M-B
- MC400-1200M
- MC400LP6 (North America or EU)
- MC400LP5 (Asia Pacific or Saudi Arabia)
- MC400LP4 (AT&T, Verizon, T-Mobile, and Canada)

Extensibility

- COR Extensibility Dock (Part # 170700-000)
- 9-wire power/GPIO cable (Part # 170680-000)
- COR Extensibility Port to Serial Cable (Part # 170767-000)

Power:

Vehicle Options

- Vehicle locking power adapter for COR (Part # 170635-000)
- Two-meter 4-wire power/GPIO cable, direct wire (Part # 170585-000)

Power Supplies/Adapters

- North America COR IBR900/IBR950 power supply (Part # 170716-000)
- International power supply — includes adapters for US, EU, UK, AU (Part # 170717-000)
- Barrel to 4-pin power adapter (Part # 170665-000)
- Extended temperature AC power supply (Part # 170648-001; [see line cord details](#))

Antennas – 3G/4G Modem, WiFi & GPS:

- Black, Universal 600MHz-6GHz 3G/4G/LTE 2dBi/3dBi 6" antenna with SMA connector (1x) Part # 170760-000
- 2.4/5 GHz Dual-band, Dual-concurrent WiFi Antenna Part # 170628-000 (WiFi models only)

Vehicle Antennas:

See the [Cradlepoint Certified Antennas for Mobile](#) for more information about antennas. Also see the [Antenna Ordering and Installation Guide](#), also available in the Resources section of antenna and router product pages.

Enterprise-Class Modem Specifications

COR IBR900-1200M-B

COR IBR900-1200M-B models include an embedded, LTE Advanced Pro modem with SIM-based, auto carrier selection. Simply insert the SIM, and wait for the router to automatically detect the SIM and establish a connection.

- Technology: Category 18 LTE Advanced Pro, DC-HSPA+ with SIM-based auto carrier selection
- Downlink Rates: LTE 1000 Mbps, DC-HSPA+ 42.2 Mbps*
- Uplink Rates: LTE 150 Mbps, DC-HSPA+ 5.76 Mbps*
- MIMO: 2x2 MIMO
- 256 QAM support
- Frequency Bands:
 - LTE Bands
 - LTE FDD: 2(25), 4(66), 5(26), 12(17), 13, 14, 29, 71
- Carrier Aggregation: Up to 5CA.
 - AT&T:
 - LTE FDD: 2, 4, 5, 12, 13, 14, 17, 25, 26, 29 (DL), 66, 71 (FDD)
 - 3G DC-HSPA+: 1, 2, 4, 5, 8

- 2CA DL carrier aggregation combinations:
CA_2A-4A, CA_2A-5A, CA_2A-12A, CA_2A-14A, CA_2A-29A, CA_2A-66A, CA_2A-71A, CA_4A-5A, CA_4A-12A, CA_4A-29A, CA_4A-71A, CA_5A-66A, CA_12A-66A, CA_14A-66A, CA_25A-26A, CA_29A-66A, CA_66A-71A, CA_2A-2A, CA_4A-4A, CA_25A-25A, CA_66A-66A, CA_2C, CA_5B, CA_12B, CA_66B, CA_66C
- 3CA DL carrier aggregation combinations:
CA_2A-2A-5A, CA_2A-2A-12A, CA_2A-2A-66A, CA_2A-2A-71A, CA_2A-4A-4A, CA_2A-4A-5A, CA_2A-4A-12A, CA_2A-4A-29A, CA_2A-4A-71A, CA_2A-5A-66A, CA_2A-12A-66A, CA_2A-12B, CA_2A-14A-66A, CA_2A-66A-66A, CA_2A-66A-71A, CA_2A-66C, CA_2A-66C, CA_4A-4A-5A, CA_4A-4A-12A, CA_4A-4A-71A, CA_4A-12B, CA_5A-66A-66A, CA_5A-66C, CA_12A-66A-66A, CA_12A-66C, CA_14A-66A-66A, CA_25A-25A-26A, CA_29A-66A-66A, CA_66A-66A-71A
- 4CA DL carrier aggregation combinations:
CA_2A-2A-5A-66A, CA_2A-2A-12A-66A, CA_2A-2A-66A-66A, CA_2A-2A-66A-71A, CA_2A-2A-66C, CA_2A-4A-4A-12A, CA_2A-5A-66A-66A, CA_2A-5B-66A, CA_2A-12A-66A-66A, CA_2A-66A-66A-71A, CA_2A-66C-71A, CA_2C-66A-66A, CA_5B-66A-66A
- 5CA DL carrier aggregation combinations:
CA_2A-5B-66A-66A
- 2CA UL carrier aggregation combinations:
UL_2A-5A, UL_2A-12A, UL_4A-12A, UL_5A-66A, UL_5B

— Verizon

- LTE FDD: 2, 4(66), 5, 13
- 3G (Roaming): 1, 2, 4, 5, 8
- 2CA DL carrier aggregation combinations:
CA_2A-2A, CA_2A-4A, CA_2A-5A, CA_2A-13A, CA_2A-66A, CA_4A-4A, CA_4A-5A, CA_4A-13A, CA_5A-66A, CA_5B, CA_13A-66A, CA_66A-66A, CA_66B, CA_66C
- 3CA DL carrier aggregation combinations:
CA_2A-2A-5A, CA_2A-2A-13A, CA_2A-2A-66A, CA_2A-4A-5A, CA_2A-4A-13A, CA_2A-5A-66A, CA_2A-13A-66A, CA_2A-66A-66A, CA_2A-66B, CA_2A-66C, CA_4A-4A-5A, CA_4A-4A-13A, CA_5A-66A-66A, CA_5A-66B, CA_5A-66C, CA_13A-66A-66A, CA_13A-66B, CA_13A-66C, CA_66A-66C, CA_66D
- 2CA UL carrier aggregation combinations:
CA_2A-13A, CA_4A-13A

- Fallback: WCDMA/DC-HSPA+ (42/5.76 Mbps): Bands 1, 2, 4, 5, 8
- Power: LTE 23 dBm ± 1, DC-HSPA+ 23 dBm ± 1
- Antennas: SMA & RP-SMA male plugs, maximum torque not to exceed 4 in-lbs
- GPS: Active GPS support
- SMS: SMS support
- Industry Standards & Certs: FCC, PTCRB, AT&T, FirstNet, Verizon

COR IBR900-1200M-NA

COR IBR900-1200M models include an embedded LTE Advanced Pro 4G LTE modem with SIM-based, auto carrier selection for FirstNet, AT&T, and Verizon. Simply insert the SIM and wait for the router to automatically detect the SIM and establish a connection.

- Technology: Category 18 LTE Advanced Pro, DC-HSPA+
- Downlink Rates: LTE 1 Gbps, DC-HSPA+ 42.2 Mbps*
- Uplink Rates: LTE 150 Mbps, DC-HSPA+ 5.76 Mbps*

- MIMO: 2x2 MIMO
- 256 QAM support
- Frequency Bands:
 - LTE Bands
 - LTE FDD: 2, 4(66), 5, 12, 13, 14, 29
- Carrier Aggregation: Up to 5CA. [] indicates 4x4 MIMO
 - AT&T: 2,4,5,12,14,29,66; 3G 2, 5
 - 2CA DL carrier aggregation combinations:
CA_2A-2A, CA_2A-4A, CA_2A-5A, CA_2A-12A, CA_2A-14A, CA_2A29A, CA_2A-66A, CA_2C, CA_4A-4A, CA_4A-5A, CA_4A-12A, CA_4A-29A, CA_5A-66A, CA_5B, CA_12A-66A, CA_12B, CA_14A-66A, CA_29A-66A, CA_66^a-66A, CA_66B, CA_66C
 - 3CA DL carrier aggregation combinations:
CA_2A-2A-5A, CA_2A-2A-12A, CA_2A-2A-14A, CA_2A2A-66A, CA_2A-4A-4A, CA_2A-4A-4A, CA_2A-4A-5A, CA_2A-4A-5A, CA_2A-4A-12A, CA_2A-4A-12A, CA_2A-5A-66A, CA_2A-5A-66A, CA_2A-12A-66A, CA_2A-12A-66A, CA_2A-14A-66A, CA_2A-66A-66A, CA_4A-4A-5A, CA_4^a-4A-12A, CA_4A-12B, CA_5A-66A-66A, CA_5A-66C, CA_12A-66A-66A, CA_14A-66A-66A, CA_29A-66A-66A
 - 4CA DL carrier aggregation combinations:
CA_2A-2A-5A-66^a, CA_2A-2A12A-66A, CA_2A-2A-14A-66A, CA_2A-2A-66A-66A, CA_2A-4A-4A-12A, CA_2A-5A-66A-66A, CA_2A-5B-66A, CA_2A-12A-66A-66A, CA_2A-14A66A-66A, CA_5B-66A-66A
 - 5CA DL carrier aggregation combinations:
CA_2A-5B-66A-66A
 - 2CA UL carrier aggregation combinations:
CA_2A-12A, CA_2A-5A, CA_4A-12A, CA_5A-66A, CA_5B, CA_12A-66A
 - Verizon
 - LTE FDD: 2, 4(66), 5, 13
 - 3G (Roaming): 1, 2, 4, 5, 8
 - 2CA DL carrier aggregation combinations:
CA_2A-2A, CA_2A-4A, CA_2A-5A, CA_2A-13A, C_2A-66A, CA_4A-4A, CA_4A-5A, CA_4A-13A, CA_5A-66A, CA_5B, CA_13A-66A, CA_66A-66A, CA_66B, CA_66C,
 - 3CA DL carrier aggregation combinations:
CA_2A-2A-5A, CA_2A-2A-13A, CA_2A-2A-66A, CA_2A-2A-66A, CA_2A-4A-5A, CA_2A-4A-5A, CA_2A-4A-13A, CA_2A-4A-13A, CA_2A-5A-66A, CA_2A-5A-66A, CA_2A-13A-66A, CA_2A-13A-66A, CA_2A-66A-66A, CA_2A-66A-66A, CA_2A-66B, CA_2A-66C, CA_4A-4A-5A, CA_4A-4A-13A, CA_5A-66A-66A, CA_5A-66B, CA_5A-66C, CA_13A-66A-66A, CA_13A-66B, CA_13A-66C, CA_66A-66C, CA_66D
 - 2CA UL carrier aggregation combinations:
CA_2A-13A, CA_4A-13A
- Fallback: WCDMA/DC-HSPA+ (42/5.76 Mbps): Bands 1, 2, 4, 5, 8
- Power: LTE 23 dBm ± 1, DC-HSPA+ 23 dBm ± 1
- Antennas: SMA & RP-SMA male plugs, maximum torque not to exceed 4 in-lbs
- GPS: Active GPS support
- SMS: SMS support
- Industry Standards & Certs: FCC, PTCRB, AT&T, FirstNet, Verizon

COR IBR900-600M-NA / -EU

COR IBR900-600M models include an embedded LTE Advanced 600 Mbps 4G LTE modem. The 600M modems support worldwide, SIM-based, auto-carrier selection. Simply insert the SIM, and wait for the router to automatically detect the SIM and establish a connection.

- Technology: Category 11 LTE Advanced, HSPA+
- Downlink Rates: LTE 600 Mbps, HSPA+ 42.2 Mbps*
- Uplink Rates: LTE 75 Mbps, HSPA+ 5.76 Mbps*
- Frequency Bands:
 - LTE Bands
 - LTE FDD: 1-5, 7-8, 12-13, 17, 20, 25-26, 28-30, 66
 - LTE TDD: 38, 40-41
 - HSPA+: 1-2, 4-5, 8
 - LTE 2DL Carrier Aggregation Combinations:

B2+B2, B2+B4, B2+B5, B2+B12, B2+B13, B2+B17, B2+B29, B2+B30, B4+B4, B4+B5, B4+B7, B4+B12, B4+B13, B4+B17, B4+B29, B4+B30, B5+B30, B12+B12, B12+B30, B25+B25, B25+B26, B25+B41, B26+B41, B29+B30, B41+B41, B1+B20, B3+B3, B3+B7, B3+B20, B3+B38, B7+B7, B7+B8, B7+B20, B38+B38, B1+B3, B1+B7, B1+B28, B3+B8, B3+B28, B5+B7, B5+B40, B7+B8, B7+B20
 - LTE 3DL Carrier Aggregation Combinations:

B2+B2+B12/17, B2+B2+B13, B2+B2+B4, B2+B4+B5, B2+B4+B12, B2+B4+B13, B2+B4+B29, B2+B5+B30, B2+B12+B12, B2+B12+B30, B2+B29+B30, B4+B4+B5, B4+B4+B7, B4+B4+B12, B4+B4+B13, B4+B5+B30, B4+B12+B12, B4+B12+B30, B4+B29+B30, B25+B26+B41, B25+B41+B41, B26+B41+B41, B41+B41+B41, B1+B3+B20, B1+B7+B20, B3+B3+B7, B3+B3+B20, B3+B7+B20, B3+B7+B7, B3+B20+B38, B3+B38+B38, B3+B3+B5, B3+B3+B8, B3+B7+B7, B3+B7+B28, B7+B7+B28, B28+B40+B40, B40+B40+B40
- Fallback: WCDMA/DC-HSPA+ (42/5.76 Mbps): Bands 1, 2, 4, 5, 8
- Power: LTE 23 dBm ± 1, HSPA+ 23 dBm ± 1
- Antennas: SMA & RP-SMA male plugs, torque not to exceed 4 in-lbs
- GPS: Active GPS support
- SMS: SMS support
- Industry Standards & Certs: CE, FCC, GCF-CC, IC, PTCRB, AT&T, Sprint, Sprint Curiosity™ IoT, Verizon, Verizon NEMO/DMNR for Primary Wireless Access, AS, NZS, SGP (IMDA)

COR IBR900LP5-AP, COR IBR950LP5-AP

COR IBR900/IBR950LP5 models include an embedded LTE Advanced 300 Mbps 4G LTE modem, and support Asia Pacific and Saudi Arabia. The LP5 modems support SIM-based, auto-carrier selection. Simply insert the SIM, and wait for the router to automatically detect the SIM and establish a connection.

- Technology: FDD/TDD (300 Mbps) LTE Advanced, DC-HSPA+
- Downlink Rates: LTE 300 Mbps, DC-HSPA+ 42.2 Mbps*
- Uplink Rates: LTE 50 Mbps, DC-HSPA+ 5.76 Mbps*

- Frequency Bands:
 - LTE Bands: 1, 3, 5, 7, 8, 18, 19, 21, 28, 38, 39, 40, 41
 - TD-SCDMA 39
 - Carrier Aggregation:
 - 1 + 8/18/19/21, 3 + 5/7/19/28, 5 + 3/7, 7 + 3/5/7/28, 8 + 1, 18 + 1, 19 + 1/3/21, 21 + 1/19, 28 + 3/7, 38 + 38, 39 + 39, 40 + 40, 41 + 41
 - Fallback: WCDMA/DC-HSPA+ (42/5.76 Mbps): Bands 1, 5, 6, 8, 9, 19
 - Power: LTE: 23 dBm ± 1; DC-HSPA+: 23 dBm ± 1
 - Antennas: SMA & RP-SMA male plugs, maximum torque not to exceed 4 in-lbs
 - GPS: Active GPS support
 - SMS: SMS support
 - Industry Standards & Certs: CE, GCF-CC, RC Australia, others pending
-

*Theoretical

**Theoretical max speed with 2 LTE antennas

Support & Warranty

The COR IBR900 series endpoints are only sold as components of NetCloud Packages.

- NetCloud Packages include support for the full subscription term.
- All Cradlepoint hardware products are covered by a limited lifetime warranty for as long as they have a subscription license to an active NetCloud Service Plan.

FirstNet and FirstNet Ready are registered trademarks and service marks of the First Responder Network Authority, an independent authority within the U.S. Department of Commerce.



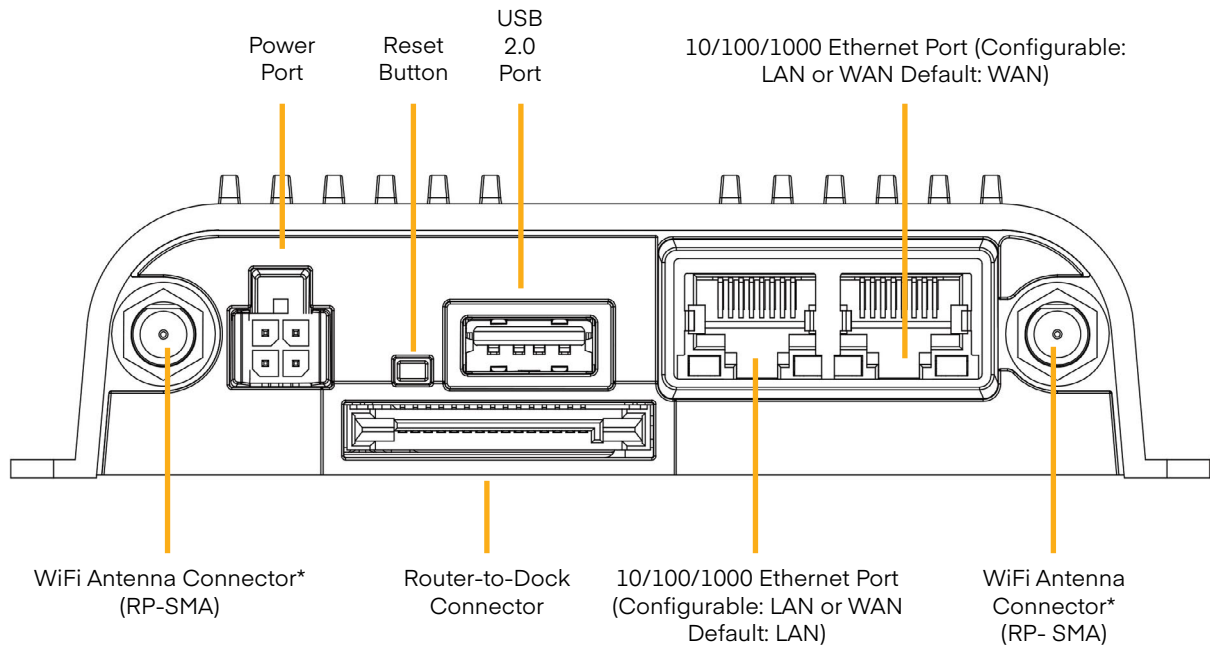
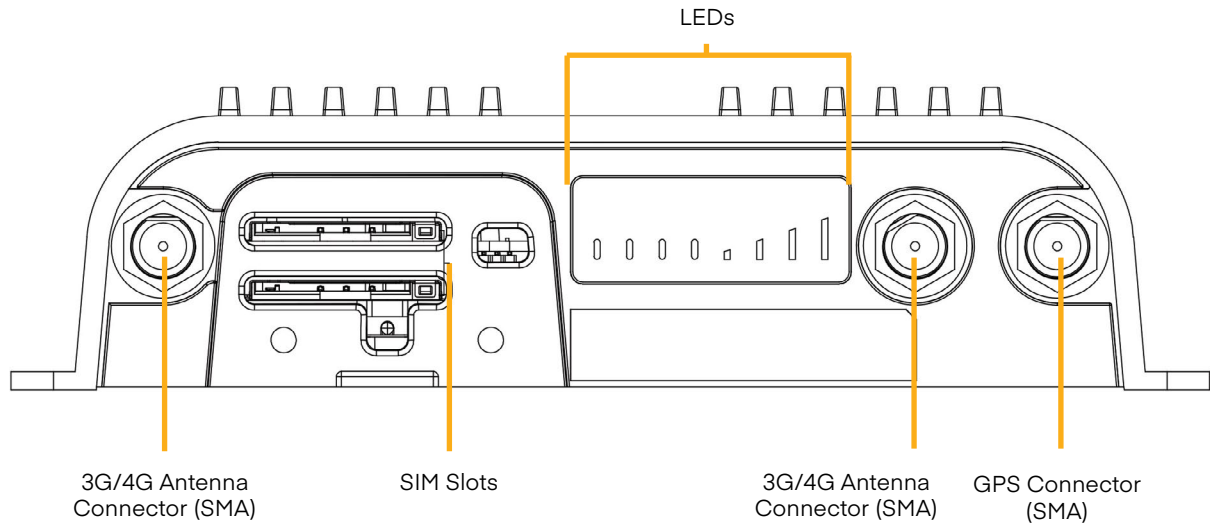

Hardware

COR IBR900-1200M-B & 600M



* Only on IBR900

LEDs

Indicator	Behavior
	<p>Power: The Cradlepoint IBR900/IBR950 must be powered using an approved 9–33 V DC power source.</p> <ul style="list-style-type: none"> — Green = Powered ON. — No Light = Not receiving power. Check the power source connection.
	<p>WiFi Broadcast: Indicates WiFi activity (IBR900 only).</p> <ul style="list-style-type: none"> — Green = On and operating normally. — Yellow = Attention.
	<p>GPS: Indicates the status of GPS connection.</p> <ul style="list-style-type: none"> — Blue = GPS locked. — Blinking Blue = Obtaining lock. — No Light = Off/no lock.
	<p>Embedded Modem: Indicates information about the embedded modem.</p> <ul style="list-style-type: none"> — Green = Modem has established an active connection. — Blinking Green = Modem is connecting. — Amber = Modem is not active. — Blinking Amber = Data connection error. No modem connection possible. — Blinking Red = Modem is in the process of resetting. — No Light = Modem not connected.
	<p>Signal Strength: Blue LED bars indicate the active modem’s signal strength.</p> <ul style="list-style-type: none"> — 4 Solid Bars = Strongest signal. — 1 Blinking Bar = Weakest signal. (A blinking bar indicates half of a bar.)
<p>Other</p>	<p>Additional LED Indicators:</p> <ul style="list-style-type: none"> — Several different LEDs blink when the factory reset button is detected. — Two of the modem LEDs blink red in unison for 10 seconds when there is an error during NCOS upgrade. — Dock Ethernet LEDs: only right LED will light up and/or blink with data. — When an external USB modem is plugged in, only the Signal Strength LEDs will light up.