

At your side.

brother®

USER'S GUIDE

FAX-T104 Series

FAX-T106 Series



brother® At your side.

If you need to call Customer Service

Please complete the following information for future reference:

Model Number: FAX-T104, FAX-T106

Serial Number:* _____

Date of Purchase: _____

Place of Purchase: _____

* The serial number is on the back of the unit. Retain this User's Guide with your sales receipt as a permanent record of your purchase, in the event of theft, fire or warranty service.

Register your product on-line at

<http://www.brother.com/registration>

By registering your product with Brother, you will be recorded as the original owner of the product.

THIS EQUIPMENT IS DESIGNED TO WORK WITH A TWO WIRE ANALOGUE PSTN LINE FITTED WITH THE APPROPRIATE CONNECTOR.

APPROVAL INFORMATION

Brother advises that this product may not function correctly in a country other than where it was originally purchased, and does not offer any warranty in the event that this product is used on public telecommunication lines in another country.

Compilation and Publication Notice

Under the supervision of Brother Industries Ltd., this manual has been compiled and published, covering the latest product descriptions and specifications.

The contents of this manual and the specifications of this product are subject to change without notice.

Brother reserves the right to make changes without notice in the specifications and materials contained herein and shall not be responsible for any damages (including consequential) caused by reliance on the materials presented, including but not limited to typographical and other errors relating to the publication.



EC Declaration of Conformity under the R & TTE Directive

Manufacturer

Brother Industries, Ltd.,
15-1, Naeshiro-cho, Mizuho-ku,
Nagoya 467-8561, Japan

Plant

Brother Industries Technology (M) Sdn Bhd Factory 2
No.6 Jalan Firma 1,
Kawasan Perindustrian Tebrau,
81100 Johor Bahru, Johor Darul, Takzim, Malaysia

Herewith declare that:

Products description : Facsimile Machine
Type : Group 3
Model Name : FAX-T102, FAX-T104, FAX-T106

are in conformity with provisions of the R & TTE Directive (1999/5/EC) and we declare compliance with the following standards :

Harmonized standards applied:

Safety : EN60950:2000
EMC : EN55022:1998 + A1:2000 + A2:2003 Class B
EN55024:1998 + A1:2001
EN61000-3-2:2000
EN61000-3-3:1995 + A1:2001

Year in which CE marking was First affixed : 2004

Issued by : Brother Industries, Ltd.
Date : 23 / 7 / 2004
Place : Nagoya, Japan
Signature :





Takashi Maeda, Manager
Quality Management Group
Quality Management Dept.
Information & Document Company

Safety precautions

To use the fax machine safely

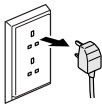
Please refer to these instructions for later reference and before attempting any maintenance.

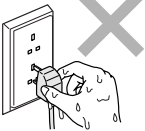
WARNING

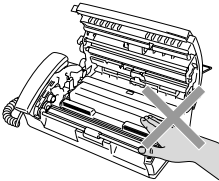
| | | |
|--|---|--|
|  | <p>There are high voltage electrodes inside the fax machine. Before you clean the fax machine, make sure you have unplugged the telephone line cord first and then the power cord from the electrical socket.</p> |  |
|  | <p>Do not handle the plug with wet hands. Doing this might cause an electrical shock.</p> |  |
|  | <p>After you have just used the fax machine, some internal parts are extremely HOT! Please be careful.</p> |  |

WARNING

- Use caution when installing or modifying telephone lines. Never touch telephone wires or terminals that are not insulated unless the telephone line has been disconnected at the wall socket. Never install telephone wiring during a lightning storm. Never install a telephone socket in a wet location.
- This product must be installed near an electrical socket that is easily accessible. In case of emergencies, you must disconnect the power cord from the electrical socket in order to shut off power completely.

IMPORTANT SAFETY INSTRUCTION

When using your telephone equipment, basic safety precautions should always be followed to reduce the risk of fire, electric shock and injury to persons, including the following:

1. Do not use this product near water, for example, near a bath tub, wash bowl, kitchen sink or washing machine, in a wet basement or near a swimming pool.
2. Avoid using this product (other than a cordless type) during an electrical storm. There may be a remote risk of electric shock from lightning.
3. Do not use this product to report a gas leak in the vicinity of the leak.
4. Use only the power cord provided with the fax machine.

SAVE THESE INSTRUCTIONS

Choosing a location

Place the fax machine on a flat, stable surface that is free of vibration and shocks, such as a desk. Put the fax machine near a telephone socket and a standard, grounded electrical socket. Choose a location where the temperature remains between 10°C-35°C.

! Caution

- Avoid placing the fax machine in a high-traffic area.
- Do not place near heaters, air conditioners, water, chemicals, or refrigerators.
- Do not expose the fax machine to direct sunlight, excessive heat, moisture, or dust.
- Do not connect the fax machine to electrical sockets controlled by wall switches or automatic timers.
- Disruption of power can wipe out information in the fax machine's memory.
- Do not connect the fax machine to electrical sockets on the same circuit as large appliances or other equipment that might disrupt the power supply.
- Avoid interference sources, such as speakers or the base units of cordless phones.

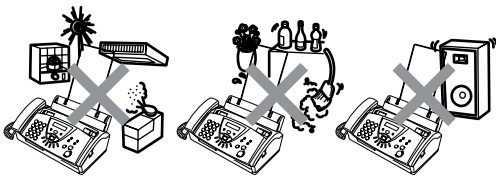

Quick Reference Guide

Sending faxes

Automatic transmission

- 1 Insert the document face down in the ADF (up to 10 pages).
- 2 Enter the fax number you want to call.
- 3 Press **Fax Start**.

Receiving faxes

Select Receive Mode

- 1 For FAX-T104, press **Receive Mode** to select FAX ONLY, FAX/TEL, TAD:ANSWER MACH. or MANUAL.
For FAX-T106, press **Receive Mode** to select FAX ONLY, FAX/TEL, or MANUAL.
Press  to select TAD:MSG MGR.

If you select FAX/TEL, make sure you set Ring Delay and F/T Ring Time. (See *Setting the Ring Delay* on page 5-2 and *Setting the F/T Ring Time (FAX/TEL mode only)* on page 5-3.)

Storing numbers

Storing One-Touch Dial numbers

- 1 Press **Menu/Set, 6, 1**.
- 2 Press a One-Touch key where you want to store a number.
- 3 Enter a number (up to 20 digits), and then press **Menu/Set**.
- 4 Enter a name up to 15 characters (or leave it blank), and then press **Menu/Set**.

- 5 Press **▲** or **▼** to select the type of number and press **Menu/Set**.

- 6 Press **Stop/Exit**.

Storing Speed-Dial numbers

- 1 Press **Menu/Set, 6, 2**.
- 2 Using the dial pad, enter a two-digit Speed-Dial location number (00-99), and then press **Menu/Set**.
- 3 Enter a number (up to 20 digits), and then press **Menu/Set**.
- 4 Enter a name (up to 15 characters) or leave it blank, and then press **Menu/Set**.
- 5 Press **▲** or **▼** to select the type of number and press **Menu/Set**.
- 6 Press **Stop/Exit**.

Dialling operations

One-Touch Dialling

- 1 Insert the document face down in the ADF.
- 2 Press the One-Touch key of the number you want to call.
- 3 Press **Fax Start**.

Speed-Dialling

- 1 Insert the document face down in the ADF.
- 2 Press **Search/Mute**, then press **#** and the two-digit Speed-Dial number.
- 3 Press **Fax Start**.

Using Search

- 1 Insert the document face down in the ADF.
- 2 Press **Search/Mute** and use the dial pad to enter the first letter of the name you are looking for.
- 3 Press ◀ or ▶ to search the memory.
- 4 Press **Fax Start**, when the LCD shows the name you want to call.

Making copies

Making a single copy

- 1 Insert the document face down in the ADF.
- 2 Press **Copy/Reports** twice.

Sorting multiple copies

- 1 Insert the document face down in the ADF.
- 2 Press **Copy/Reports**.
- 3 Enter the number of copies you want (up to 99).
- 4 Press **Menu/Set**.
- 5 Press ▲ or ▼ to select **Sort**, and then press **Copy/Reports**.

Message Manager (FAX-T106 only)

Turning ON Message Manager Mode

- 1 Record the Outgoing Message (TAD MESSAGE).
- 2 Press  until it lights.

Recording OGM

- 1 Press **Menu/Set**, **8**, **4**.
- 2 Press ▲ or ▼ to select **TAD MESSAGE**, and then press **Menu/Set**.
- 3 Press ▲ or ▼ to reach **RECORD MSG**, and then press **Menu/Set**.
- 4 Pick up the handset to record a message.
- 5 Replace the handset.

Playing a Voice Message

- 1 Press **Play/Record**.
- 2 Use ◀◀ (RWD) to repeat a message.
Use ▶▶ (FWD) to skip a message.
- 3 Press **Stop/Exit**.

Printing a Fax Message

- 1 Press **Play/Record**.
- 2 After voice messages have played, press **1**.

Erasing Messages

To erase voice messages individually

- 1 Press **Play/Record**.
- 2 Press **Erase** after the two short beeps.
- 3 Press **1**.
- 4 Press **Stop/Exit**.

To erase messages all at once

- 1 Press **Erase**.
- 2 Press ▲ or ▼ to select **ERASE ALL VOICE?**, **ERASE ALL DOC?**, **ERASE ALL MSG.?**, and then press **Menu/Set**.
- 3 Press **1**.
- 4 Press **Stop/Exit**.

Table of Contents

| | | |
|----------|---|------------|
| 1 | Introduction | 1-1 |
| | Using this Guide | 1-1 |
| | Finding information | 1-1 |
| | Symbols used in this Guide | 1-1 |
| | Part names | 1-2 |
| | FAX-T104 control panel overview..... | 1-3 |
| | FAX-T106 control panel overview..... | 1-5 |
| | About fax machines | 1-7 |
| | Custom features | 1-7 |
| | Fax tones and handshake | 1-8 |
| | ECM (Error Correction Mode)..... | 1-8 |
| | Connections..... | 1-9 |
| | Connecting an external telephone | 1-9 |
| | Connecting an external telephone answering device (TAD)..... | 1-9 |
| | Multi-Line connections (PABX) | 1-12 |
| | Custom features on your phone line..... | 1-12 |
| 2 | Paper | 2-1 |
| | About paper | 2-1 |
| | Handling and using plain paper | 2-1 |
| | How to load paper..... | 2-2 |
| 3 | On-Screen Programming | 3-1 |
| | User-friendly programming | 3-1 |
| | Menu table | 3-1 |
| | Memory Storage | 3-1 |
| | Navigation keys | 3-2 |
| 4 | Initial Setup | 4-1 |
| | Getting started | 4-1 |
| | Setting the Date and Time | 4-1 |
| | Turning on Automatic Daylight Savings Time..... | 4-1 |
| | Setting the Station ID..... | 4-2 |
| | Setting the Beeper Volume..... | 4-4 |
| | Setting the Speaker Volume | 4-4 |
| | Setting the Ring Volume | 4-5 |
| | Setting the Phone Line Set..... | 4-5 |
| | Setting Tone or Pulse dialling mode | 4-5 |
| | Melody Settings (FAX-T106 only)..... | 4-6 |
| | Setting the Ring Pattern..... | 4-6 |
| | Setting the Music on Hold..... | 4-6 |

| | | |
|----------|--|------------|
| 5 | Setup Receive | 5-1 |
| | Basic receiving operations..... | 5-1 |
| | Choosing the Receive Mode..... | 5-1 |
| | Setting the Ring Delay | 5-2 |
| | Setting the F/T Ring Time (FAX/TEL mode only) | 5-3 |
| | Recording the Fax/Tel Outgoing Announcement (F/T MESSAGE) (FAX-T106 only) | 5-3 |
| | Fax Detect | 5-4 |
| | Printing a reduced incoming fax (Auto Reduction) | 5-4 |
| | Reception into memory..... | 5-5 |
| | Receiving a fax at the end of a conversation..... | 5-5 |
| | Advanced receiving operations..... | 5-6 |
| | Operation from extension telephones..... | 5-6 |
| | For FAX/TEL mode only | 5-6 |
| | Remote Call Transfer..... | 5-6 |
| | Changing the remote codes | 5-7 |
| | Printing a fax from the memory (FAX-T104 only) | 5-8 |
| | Polling..... | 5-8 |
| | Sequential Polling..... | 5-9 |
| | Telephone Services..... | 5-10 |
| | Caller ID (Caller IDentification) (U.K. only) | 5-10 |
| | Advantages of Caller ID..... | 5-10 |
| | Set the Caller ID to ON..... | 5-10 |
| | How Does the Caller ID Work?..... | 5-11 |
| | Selecting a Caller ID from the Memory for Call Reply..... | 5-12 |
| | BT Call Sign (U.K. only)..... | 5-14 |
| 6 | Setup Send | 6-1 |
| | How to dial..... | 6-1 |
| | Manual dialling..... | 6-1 |
| | One-Touch dialling..... | 6-1 |
| | Speed-dialling..... | 6-1 |
| | Search | 6-1 |
| | Fax Redial..... | 6-2 |
| | How to fax..... | 6-2 |
| | Automatic transmission..... | 6-2 |
| | Manual transmission..... | 6-3 |
| | Sending a fax at the end of a conversation | 6-3 |
| | Basic sending operations..... | 6-3 |
| | Sending faxes using multiple settings..... | 6-3 |
| | Contrast | 6-4 |
| | Fax resolution | 6-4 |
| | Multiple Resolution Transmission | 6-5 |
| | Cancelling a fax in progress | 6-5 |
| | Cancelling a scheduled job..... | 6-5 |
| | Advanced sending operations | 6-6 |
| | Composing the electronic Cover Page | 6-6 |
| | Broadcasting..... | 6-8 |
| | Overseas Mode | 6-8 |
| | Call Reservation | 6-9 |
| | Delayed Fax..... | 6-10 |
| | Setting up Polled Transmit (Standard)..... | 6-11 |

| | |
|---|------|
| Setup for Polling Transmit with Secure Code | 6-11 |
| Secure Polling..... | 6-12 |
| Memory Transmission | 6-12 |
| Out of Memory message | 6-13 |
| Interrupting Delayed Fax and Polled Transmit jobs..... | 6-13 |
| TX Lock System..... | 6-13 |

7 Quick-Dial numbers and dialling options.....7-1

| | |
|--|-----|
| Storing numbers for easy dialling | 7-1 |
| Storing One-Touch Dial numbers | 7-1 |
| Storing Speed-Dial numbers..... | 7-2 |
| Changing One-Touch and Speed-Dial numbers..... | 7-2 |
| Setting up Groups for Broadcasting..... | 7-3 |
| Dialling options | 7-4 |
| Manual dialling..... | 7-4 |
| On Hook dialling | 7-4 |
| One-Touch dialling..... | 7-5 |
| Speed-Dialling | 7-5 |
| Search | 7-6 |
| Pause..... | 7-6 |
| Mute..... | 7-6 |
| Answering Calls with the Speaker Phone (FAX-T106 only)..... | 7-6 |
| Redial (Telephone) | 7-7 |
| Redial (Fax) | 7-7 |
| Tone or Pulse | 7-7 |

8 Remote Fax Options (FAX-T104 only)8-1

| | |
|---|-----|
| Fax Forwarding..... | 8-1 |
| Setting up Fax Forwarding..... | 8-1 |
| Setting Fax Storage | 8-2 |
| Turning off Remote Fax Options..... | 8-2 |
| Setting your remote access code | 8-2 |
| Remote Retrieval | 8-3 |
| Using your remote access code | 8-3 |
| Remote commands..... | 8-4 |
| Retrieving fax messages | 8-5 |
| Changing your Fax Forwarding number | 8-5 |

9 Message Manager (FAX-T106 only)9-1

| | |
|---|-----|
| Message Manager Mode | 9-1 |
| Setting Up Message Manager | 9-1 |
| Setting up voice store | 9-1 |
| Setting Fax Forward/Fax Storage..... | 9-2 |
| Recording the Message Manager's Outgoing Message (TAD MESSAGE) | 9-3 |
| Activating Message Manager Mode | 9-4 |
| Message Indicator | 9-4 |
| Playing Voice Messages..... | 9-5 |
| Printing a Fax Message | 9-5 |
| Backup Printing Option..... | 9-5 |
| Erasing Messages | 9-6 |

| | |
|--|-------------|
| Setting the maximum time for incoming messages..... | 9-6 |
| Setting the Toll Saver | 9-7 |
| ICM Recording Monitor | 9-7 |
| Recording a Conversation | 9-7 |
| Remote Retrieval | 9-8 |
| Using the Remote Access Code..... | 9-8 |
| Setting your Remote Access Code..... | 9-8 |
| Remote commands..... | 9-9 |
| Retrieving the Memory Status List..... | 9-10 |
| Retrieving Fax Messages | 9-10 |
| Changing the Fax Forwarding Number..... | 9-11 |
| 10 Printing reports | 10-1 |
| FAX settings and activity | 10-1 |
| Customizing the Transmission Verification Report | 10-1 |
| Setting the Journal Period | 10-1 |
| Printing reports | 10-2 |
| How to print a report | 10-2 |
| 11 Making copies..... | 11-1 |
| Using the fax machine as a copier..... | 11-1 |
| Copy operations..... | 11-1 |
| Making a single copy | 11-1 |
| Copy options: Single or Multiple copies, Sort/Stack, Reduce/Enlarge..... | 11-2 |
| 12 Important information | 12-1 |
| Important safety instructions..... | 12-1 |
| Trademarks..... | 12-2 |
| Shipment of the fax machine..... | 12-2 |
| 13 Troubleshooting and routine maintenance..... | 13-1 |
| Troubleshooting | 13-1 |
| Error messages | 13-1 |
| Compatibility | 13-4 |
| Document Jam or Paper Jam..... | 13-4 |
| If you are having difficulty with the fax machine | 13-6 |
| Routine maintenance..... | 13-8 |
| Cleaning the print head..... | 13-8 |
| Cleaning the scanner..... | 13-9 |
| Changing the ribbon | 13-9 |
| G Glossary | G-1 |
| S Specifications | S-1 |
| General | S-1 |
| Copy | S-1 |
| Fax..... | S-2 |

I IndexI-1

A Accessory List.....A-1

1 Introduction

Using this Guide

Thank you for buying a Brother fax machine. This fax machine is simple to use, with LCD screen instructions to guide you through programming it. You can make the most of the fax machine by reading this Guide.

Finding information

All the chapter headings and subheadings are listed in the Table of Contents. You will be able to find information about a specific feature or operation by checking the Index at the back of this Guide.

Symbols used in this Guide

Throughout this Guide you'll see special symbols alerting you to important warnings, notes and actions. To make things clearer and to help you press the correct keys, we used special fonts and added some of the messages that will appear in the LCD.

Bold Bold typeface identifies specific keys on the fax machine control panel.

Italics Italicized typeface emphasizes an important point or refers you to a related topic.

`Courier New` Courier New typeface identifies the messages on the LCD of the fax machine.

 Warnings inform you what to do to avoid possible personal injury.

 Electrical Hazards alert you to possible electrical shock.

 Cautions specify procedures you must follow or avoid to prevent possible damage to the fax machine.

 Notes tell you how you should respond to a situation that may arise or give tips about how the current operation works with other features.

 Improper Setup alerts you to devices and operations that are not compatible with the fax machine.

Part names

■ Front view

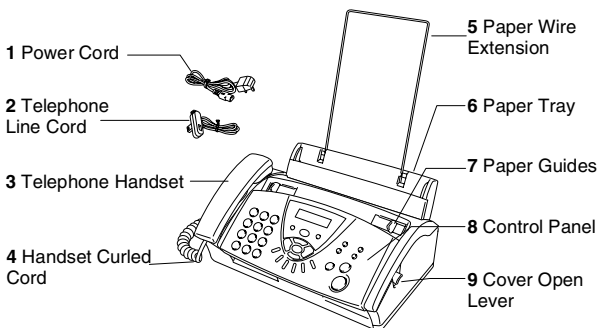

| No. | Name | Description |
|-----|----------------------|--|
| 1 | Power Cord | Use to connect the fax machine to the electrical socket. |
| 2 | Telephone Line Cord | Connect the fax machine to a telephone wall socket. |
| 3 | Telephone Handset | Use when receiving or making voice calls. |
| 4 | Handset Curled Cord | Use to connect the handset to the fax machine. |
| 5 | Paper Wire Extension | Supports the paper in the paper tray. |
| 6 | Paper Tray | Load paper here. |
| 7 | Paper Guides | Press and slide to fit the document width. |
| 8 | Control Panel | Use the keys and display to control the fax machine. |
| 9 | Cover Open Lever | To open the top cover, lift this lever. |

■ Back view

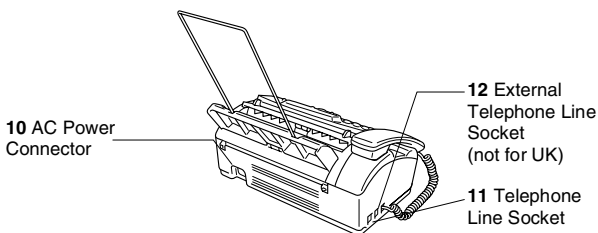

| No. | Name | Description |
|-----|--|---|
| 10 | AC Power Connector | Plug in the power cord here. |
| 11 | Telephone Line Socket (LINE) | Plug in the telephone line here. |
| 12 | External Telephone Line Socket (EXT.) (not for UK) | Plug in the telephone line of an external telephone here. |

FAX-T104 control panel overview

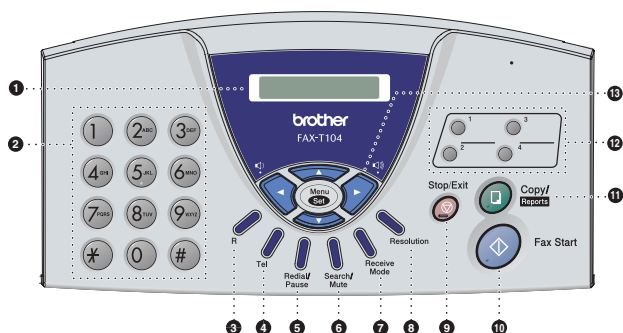

1 LCD (Liquid Crystal Display)

Displays messages on the screen to help you set up and use your fax machine.

2 Dial Pad

Use these keys to dial telephone and fax numbers and as a keyboard for entering information into the fax machine.

The # key lets you temporarily switch the dialling type during a telephone call from "PULSE" to "TONE".

3 R

Use this key to gain access to an outside line and/or to recall the operator or transfer a call to another extension when it is connected to a PABX.

4 Tel

Use to toggle the line between handset and monitor speaker.

5 Redial/Pause

Redials the last number you called. It also inserts a pause in Quick-Dial numbers.

6 Search/Mute

Lets you look up numbers stored in the dialling memory, lets you put calls on hold and lets you dial stored numbers by pressing # and a two-digit number.

7 Receive Mode

Use to select how your fax machine will handle incoming calls.

8 Resolution

Adjusts the resolution when you send a fax or make a copy.

9 Stop/Exit

Stops a fax, cancels an operation or exits from the menu.

10 Fax Start

Starts an operation, such as sending a fax.

11 **Copy/Reports**

With document in the ADF: Makes a copy.

Without document in the ADF: Lets you access the Reports menu.

12 **One-Touch Keys**

These keys give you instant access to previously stored Quick-Dial numbers.

13 **Navigation Keys:**

Menu/Set

The same key is used for menu and set operations.

Lets you access the menu to program and store your settings in the fax machine.

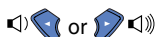

Press to scroll forward or backward to see a menu selection.

—OR—

You can press these keys to adjust the beeper, ring or speaker volume.



Press to scroll through the menus and options.

You can also use these keys to do a numerical search for stored numbers.

FAX-T106 control panel overview

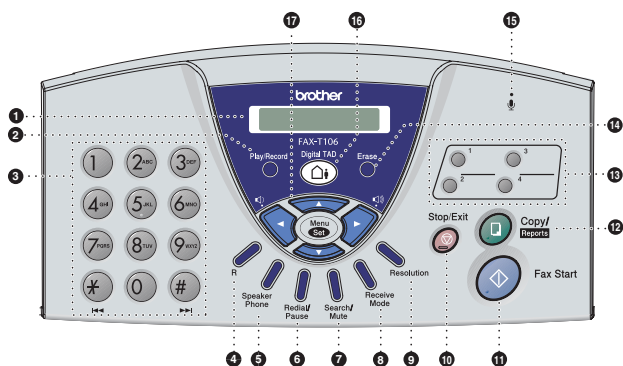

1 LCD (Liquid Crystal Display)

Displays messages on the screen to help you set up and operate your fax machine.

2 Play/Record

Lets you listen to voice messages and print fax messages stored in memory. This also lets you record telephone calls.

3 Dial Pad

Use these keys to dial telephone and fax numbers and as a keyboard for entering information into the fax machine.

key lets you switch the dialling type during a telephone call from "PULSE" to "TONE".

4 R

Use this key to gain access to an outside line and/or to recall the operator or transfer a call to another extension when it is connected to a PABX.

5 Speaker Phone

Lets you speak to another party without lifting the handset.

6 Redial/Pause

Redials the last number you called. It also inserts a pause in Quick-Dial numbers.

7 Search/Mute

Lets you look up numbers stored in the dialling memory, lets you put calls on hold and lets you dial stored numbers by pressing # and a two-digit number.

8 Receive Mode

Use to select how your fax machine will handle incoming calls.

9 Resolution

Adjusts the resolution when you send a fax or make a copy.

10 Stop/Exit

Stops a fax, cancels an operation or exits from the menu.

11 Fax Start

Starts an operation, such as sending a fax.

12 **Copy/Reports**

With a document in the ADF: Makes a copy.

Without a document in the ADF: Lets you access the Reports menu.

13 **One-Touch Dial Keys**

These keys give you instant access to previously stored Quick-Dial numbers.

14 **Erase**

Lets you delete voice messages, all fax messages or all messages.

15  **(Microphone)**

Picks up your voice when you speak to another party using Speaker Phone.

16  **Digital TAD**

Lets you activate Message Manager. Also, notifies you that you have voice or fax messages in the memory.

17 **Navigation Keys:**

Menu/Set

The same key is used for menu and set operation. Lets you access the menu to program and store your settings in the fax machine.

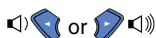

Press to scroll forward or backward to see a menu selection.

—OR—

You can press these keys to adjust ring or speaker volume.



Press to scroll through the menus and options.

You can also use these keys to do a numerical search for stored numbers.

About fax machines

Custom features

Do you have BT's Call Minder on the phone line?

If you have Call Minder on the phone line where you will install your new fax machine, there is a strong possibility that Call Minder and the fax machine may conflict with each other while receiving incoming calls.

Why should there be problems?

Since both the fax machine and Call Minder will pick up the call after the number of rings you have set, each of them has the ability to keep the other from receiving calls.

For example, if Call Minder is set to answer after two rings and the fax machine is set to answer after four, Call Minder will stop the fax machine from receiving faxes.

If you set Call Minder and the fax machine to answer after the same number of rings, there is no way of knowing which one will answer first. It is important to remember that neither Call Minder nor the fax machine can pass the call back to the other after the call has been answered.

How can you avoid possible problems?

A very good way to avoid problems like the one mentioned, *is to get a second phone number on your present phone line.*

Many people with Call Minder choose this service, which is called 'BT Call Sign', and they are very satisfied with it. (See *BT Call Sign (U.K. only)* on page 5-14.)

Another way to avoid possible problems is to replace Call Minder with an answering machine. Your fax machine is designed to work with an answering machine or TAD (telephone answering device). (See *Connecting an external telephone answering device (TAD)* on page 1-9.)

Fax tones and handshake

When someone is sending a fax, the fax machine sends fax calling tones (CNG tones). These are quiet, intermittent beeps every 4-seconds. You'll hear them after you dial and press **Fax Start** and they will continue for about 60 seconds after dialling. During that time, the sending machine must begin the "handshake" with the receiving machine.

Each time you use automatic procedures to send a fax, you are sending CNG tones over the phone line. You'll soon learn to listen for these quiet beeps each time you answer a phone on your fax line, so you will know if you are receiving a fax message.

The receiving fax responds with fax receiving tones, which are loud, chirping sounds. A receiving fax chirps for about 40 seconds over the phone line, and the LCD shows `RECEIVE`.

If the fax machine is set to the `FAX ONLY` mode, it will answer every call automatically with fax receiving tones. If the other person hangs up, the fax machine will continue to send the "chirps" for about 40 seconds, and the LCD continues to show `RECEIVE`. To cancel the receiving, press **Stop/Exit**.

The fax 'handshake' is the time in which the sending machine's CNG tones and the receiving machines "chirps" overlap. This must be for at least 2 to 4 seconds, so the fax machines can understand how each is sending and receiving the fax. The handshake cannot begin until the call is answered, and the CNG tones only last for about 60 seconds after the number is dialled. So it is important for the receiving machine to answer the call in as few rings as possible.



When you have an external Telephone Answering Device (TAD) on your fax line, your TAD will decide the number of rings before the call is answered.

Pay special attention to the directions for connecting a TAD in this chapter. (See *Connecting an external telephone answering device (TAD)* on page 1-9.)

ECM (Error Correction Mode)

The Error Correction Mode (ECM) is a way for the fax machine to check a fax transmission while it is in progress. ECM transmissions are only possible between machines that both have this feature. If they do, you may send and receive fax messages that are continuously being checked by the fax machine.

The fax machine must have enough memory for this feature to work.

Connections

Connecting an external telephone

You can connect a separate telephone as shown in the diagram below.

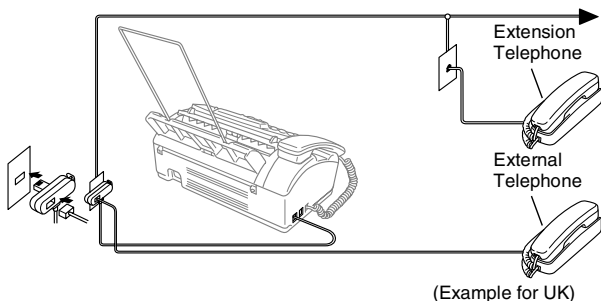

Whenever this phone (or TAD) is in use, the LCD shows **EXT. TEL IN USE** and, if the fax handset is lifted, an alarm sounds.

To disconnect the call on the external phone and switch to the fax, lift the handset and press **Tel** (FAX-T104 only) or **Speaker Phone** (FAX-T106 only).

Connecting an external telephone answering device (TAD)

Sequence

You may choose to connect an answering device. However, when you have an **external** TAD on the same telephone line as the fax machine, the TAD answers all calls and the fax machine “listens” for fax calling (CNG) tones. If it hears them, the fax machine takes over the call and receives the fax. If it doesn’t hear CNG tones, the fax machine lets the TAD continue playing your outgoing message so your caller can leave you a voice message.

The TAD must answer within four rings (the recommended setting is two rings). The fax machine cannot hear CNG tones until the TAD has answered the call, and with four rings there are only 8 to 10 seconds of CNG tones left for the fax “handshake”. Make sure you carefully follow the instructions in this manual for recording your outgoing message. We do not recommend using the toll saver feature on your external answering machine if it exceeds four rings.

 If you do not receive all your faxes, you must reset the setting on your external TAD to four rings or less.

 **Do not connect a TAD elsewhere on the same phone line.**

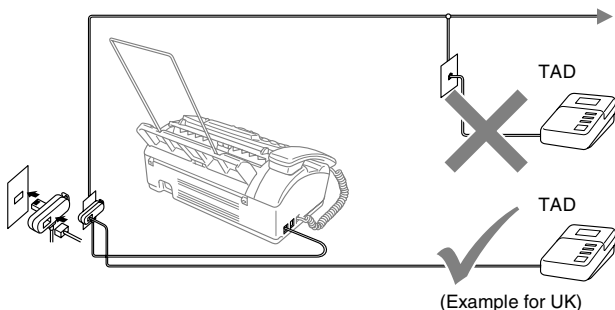

Connections

The external TAD must be connected as shown above.

- 1 Set your external TAD to one or two rings. (The fax machine's Ring Delay setting does not apply.)
- 2 Record the outgoing message on your external TAD.
- 3 Set the TAD to answer calls.
- 4 For FAX-T104, set the Receive Mode to
TAD:ANSWER MACH..
For FAX-T106, set the Receive Mode to TAD:MSG MGR.
(See *Choosing the Receive Mode* on page 5-1.)

Recording outgoing message (OGM) on an external TAD

Timing is important in recording this message. The message sets up the ways to handle both manual and automatic fax reception.

- 1 Record 5 seconds of silence at the beginning of your message. (This allows the fax machine time to listen for the fax CNG tones of automatic transmissions before they stop.)
- 2 Limit your speaking to 20 seconds.

 We recommend beginning your OGM with an initial 5-second silence because the fax machine cannot hear fax tones over a resonant or loud voice. You may try omitting this pause, but if the fax machine has trouble receiving, then you must re-record the OGM to include it.

Using extension telephones (For U.K. only)

It may be that your premises are already wired with parallel extension telephones, or you intend to add extension telephones to your line, in addition to your fax machine. While the simplest arrangement is straightforward parallel connection, there are some reasons as to why this arrangement will cause unsatisfactory service, the most obvious of which is inadvertent interruption of a facsimile transmission by someone picking up an extension telephone in order to make an outgoing call. Additionally, fax receive may not operate reliably in such a simple configuration. This fax machine may also be set to make a delayed transmission (i.e. a transmission at a pre-set time). This pre-set job may coincide with someone picking up an extension handset.

Such problems can easily be eliminated however, if you arrange modification of your extension wiring circuit, such that extension devices are connected “downstream” of your fax machine, in a master/slave configuration. In such a configuration, this fax machine can always detect whether a telephone is in use, thus it will not attempt to seize the line during that time. This is known as “telephone off-hook detection.”

The inadvisable configuration is shown in figure 1 below, and the recommended master/slave configuration is shown in figure 2. This new connection configuration can be arranged by contacting BT, Kingston upon Hull Telecommunications, your PABX maintainer or a qualified telephone installation company as appropriate. Simply explained, the extension telephone circuit should be terminated on a normal modular plug (BT 431A style), which in turn should be inserted into the modular socket of the white “T”-shaped connector provided as part of the line cord assembly.

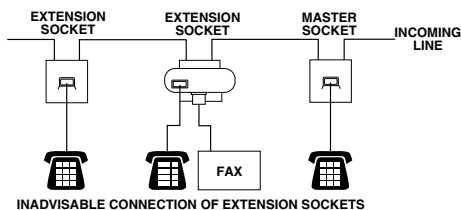

Fig. 1.

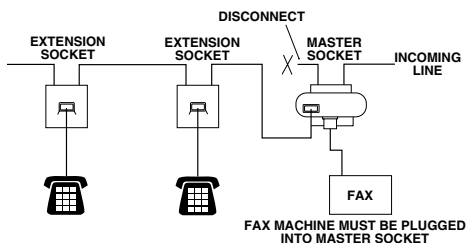

Fig. 2.



These phones are now connected as external devices as per page 1-7, because they are connected to the fax machine via the T-connector.

Multi-Line connections (PABX)

Most offices use a central telephone system. While it is often relatively simple to connect the fax machine to a key system or a PABX (Private Automatic Branch Exchange), we suggest that you contact the company that installed your telephone system and ask them to connect the fax machine for you. It is advisable to have a separate line for the fax machine.

If the fax machine is to be connected to a multi-line system, ask your installer to connect the unit to the last line on the system. This prevents the unit from being activated each time a telephone call is received.

If you are installing the fax machine to work with a PABX

- 1** It is not guaranteed that the unit will operate correctly under all circumstances with a PABX. Any cases of difficulty should be reported first to the company that handles your PABX.
- 2** If all incoming calls will be answered by a switchboard operator, it is recommended that the Receive Mode be set to **MANUAL**. All incoming calls should initially be regarded as telephone calls.

Custom features on your phone line

If you have BT Call Minder, Call Waiting, RingMaster, an answering service, an alarm system or other custom feature on one phone line it may create a problem with the operation of your fax machine. (See *Custom features on a single line* on page 13-7.)

2 Paper

About paper

Handling and using plain paper

Store paper in its original packaging, and keep it sealed. Keep the paper flat and away from moisture, direct sunlight and heat.

Paper specifications for the paper tray

| | |
|------------|---------------------------|
| Size: | A4 |
| Weight: | 64 to 90 g/m ² |
| Thickness: | 0.08 to 0.12 mm |
| Capacity: | up to 30 sheets |



The fax machine can only scan an image 208 mm wide, regardless of how wide the paper is.

Do not use cardboard, newspaper, or fabric.



Do not use paper:

- that is extremely shiny or highly textured
- that was previously printed by a printer
- that cannot be arranged uniformly when stacked
- that is made with a short grain
- that is curled, wrinkled, folded, ripped, stapled, paper-clipped, pasted, or taped

How to load paper

To load paper

Before you add paper, remove all of the paper from the paper tray.

- 1 Fan the stack of paper well to avoid paper jams and mis-feeds.

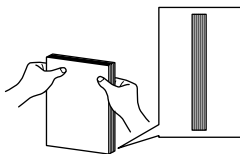

Tap the stack of paper so the edges are even.

- 2 Gently insert the paper.
The side to be printed on must be face down.

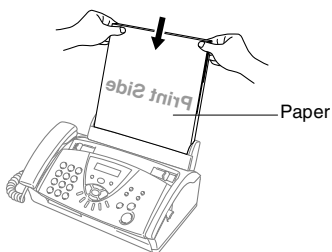

3 On-Screen Programming

User-friendly programming

The fax machine is designed to be easy to use with LCD on-screen programming using the navigation keys. User-friendly programming helps you take full advantage of all the menu selections the fax machine has to offer.

Since your programming is done on the LCD, we have created step-by-step on-screen instructions to help you program the fax machine. All you need to do is follow the instructions as they guide you through the menu selections and programming options.

Menu table

You can probably program the fax machine without the User's Guide if you use the Menu table that begins on page 3-3. These pages will help you understand the menu selections and options that are found in the fax machine programs.



You can program the fax machine by pressing **Menu/Set**, followed by the menu numbers.

For example to set **RESOLUTION** to **FINE**:







Press **Menu/Set**, **3**, **4** and **▲** or **▼** to select **FINE**.

Press **Menu/Set**.

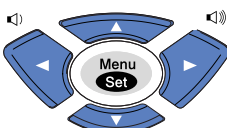
Memory Storage

If there is a power failure, you will not lose your menu settings because they are stored permanently. Temporary settings (such as Contrast, Overseas Mode, and so on) will be lost. You may also have to reset the date and time.

Navigation keys

| | | |
|---|---|--|
|  |  | Access the menu Go to the next menu level Accept an option |
| |  | Scroll through the current menu level |
| |  | Go back to the previous menu level |
| |  | Go forward to the next menu level |
| |  | Exit the menu |

You can access the menu mode by pressing **Menu/Set**.

When you enter the menu, the LCD scrolls.

Press **1** for Initial Setup

—OR—

SELECT ↑ ↓ & SET

1. INITIAL SETUP

Press **2** for Setup Receive menu

—OR—

2. SETUP RECEIVE

Press **3** for Setup Send menu

—OR—

3. SETUP SEND

Press **4** for Cancel Job menu

—OR—

4. CANCEL JOB

Press **5** for Interrupt menu

—OR—

5. INTERRUPT

Press **6** for Set Quick-Dial menu

—OR—

6. SET QUICK-DIAL

Press **7** for Setup Reports menu

—OR—

7. REPORT SETTING

Press **8** for Remote Fax Opt menu
(FAX-T104 only)

8. REMOTE FAX OPT

Press **8** for Setup TAD menu
(FAX-T106 only)

8. SETUP TAD

—OR—

Press **9** for Setup Melody menu
(FAX-T106 only)

9. SETUP MELODY

—OR—

Press **0** for Miscellaneous menu

0. MISCELLANEOUS

You can scroll more quickly through each menu level by pressing the arrow key (▲ or ▼) for the direction you want. Select an option by pressing **Menu/Set** when that option appears on the LCD. Then the LCD shows the next menu level.

Press ▲ or ▼ to scroll to your next menu selection.

Press **Menu/Set**. When you finish setting an option, the LCD shows ACCEPTED.

Press the Menu numbers.
(ex. Press 1, 1 for Date/Time)

—OR—



to select



to select

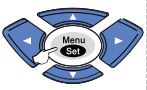

to accept

Stop/Exit



to exit

| Main Menu | Menu Selections | Options | Descriptions | Page |
|------------------|-------------------|---|--|------|
| 1. INITIAL SETUP | 1. DATE/TIME | — | Puts the date and time on the LCD and in the headings of faxes you send. | 4-1 |
| | 2. AUTO DAYLIGHT | ON OFF | Changes for Daylight Savings Time automatically. | 4-1 |
| | 3. STATION ID | — | Program your name, fax number to appear on each page you fax. | 4-2 |
| | 4. BEEPER | OFF LOW HIGH | Adjust the volume level of the beeps that sound when you press a key, an error occurs or a document is sent or received. | 4-4 |
| | 5. PHONE LINE SET | NORMAL PBX ISDN | Select the phone line type. | 4-5 |
| | 6. TONE/PULSE | TONE PULSE | Selects the dialling mode. | 4-5 |
| 2. SETUP RECEIVE | 1. RING DELAY | FAX-T104 00-04 (02-04 for Ireland) | Sets the number of rings before your fax machine answers in FAX/TEL, FAX ONLY or TAD (Message Manager for FAX-T106) mode. On FAX-T106, you can set Toll Saver feature. | 5-2 |
| | | FAX-T106 RING DELAY TOLL SAVER | | 9-7 |
| | 2. F/T RING TIME | 70 40 30 20 | Sets the time for "FAX/TEL pseudo-ring" in FAX/TEL (F/T) Mode. | 5-3 |
| 3. FAX DETECT | ON SEMI OFF | Receive fax messages without pressing the Fax Start key. | 5-4 | |



The factory setting (option) is shown in bold.

Press the Menu numbers.
(ex. Press 1, 1 for Date/Time)

—OR—

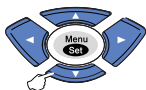

to select



to select



to accept

Stop/Exit



to exit

| Main Menu | Menu Selections | Options | Descriptions | Page |
|--------------------------------|-------------------|---|---|------|
| 2.SETUP RECEIVE (Continued) | 4. REMOTE CODE | ON (*51, #51, *81) OFF | You can answer calls at an external or extension phone and use codes to turn the fax machine on or off. You can also transfer a voice call from your cordless phone to your fax machine. You can personalize these codes. | 5-6 |
| | 5. AUTO REDUCTION | ON OFF | Reduces size of incoming faxes. | 5-4 |
| | 6. MEM. RECEIVE | ON OFF | Automatically stores any incoming faxes in its memory if it runs out of paper. | 5-5 |
| | 7. POLLING RX | STANDARD SECURE TIMER | Sets up your fax machine to poll another fax machine. | 5-8 |
| 3.SETUP SEND | 1. COVERPG SETUP | NEXT FAX ONLY ON OFF PRINT SAMPLE | Automatically sends a programmable cover page or prints a sample coverpage. | 6-6 |
| | 2. COVERPAGE NOTE | — | Program a customized message for fax cover page. | 6-6 |
| | 3. CONTRAST | AUTO LIGHT DARK | Change the lightness or darkness of a fax you are sending. | 6-4 |
| | 4. RESOLUTION | STANDARD FINE S. FINE PHOTO | Allows you to change resolutions page by page. | 6-4 |
| | 5. OVERSEAS MODE | ON OFF | If you are having difficulty sending faxes overseas, set this to on. | 6-8 |
| | 6. CALL RESERVE | ON OFF PRINT SAMPLE | You can send a fax, then speak or print a sample call back message. | 6-9 |



The factory setting (option) is shown in bold.

Press the Menu numbers.
(ex. Press 1, 1 for Date/Time)

—OR—



to select



to select

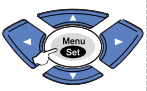

to accept

Stop/Exit



to exit

| Main Menu | Menu Selections | Options | Descriptions | Page |
|-----------------------------|-------------------|---|---|------|
| 3.SETUP SEND (Continued) | 7. DELAYED FAX | — | Set the time of day in 24 hour format that the delayed faxes will be sent. | 6-10 |
| | 8. POLLED TX | STANDARD SECURE | Set up your fax machine with a document to be retrieved by another fax machine. | 6-11 |
| | 9. MEMORY TX | NEXT FAX ONLY ON OFF | You can send faxes from memory. | 6-12 |
| 4.CANCEL JOB | — | — | Cancel a delayed fax or polling job. | 6-5 |
| 5.INTERRUPT | — | — | Send a fax now, even if you have your fax machine set to send a fax later, or if you have it set for Polling. | 6-13 |
| 6.SET QUICK-DIAL | 1. ONE-TOUCH DIAL | — | Stores One-Touch Dial numbers, so you can dial by pressing one key. | 7-1 |
| | 2. SPEED-DIAL | — | Stores Speed-Dial numbers, so you can dial by pressing a few keys. | 7-2 |
| | 3. SETUP GROUPS | — | Sets up a Group number for broadcasting. | 7-3 |
| 7.REPORT SETTING | 1. XMIT REPORT | ON OFF | Initial setup for Transmission Verification Report and Fax Journal period. | 10-1 |
| | 2. JOURNAL PERIOD | EVERY 30 FAXES EVERY 6 HOURS EVERY 12 HOURS EVERY 24 HOURS EVERY 2 DAYS EVERY 7 DAYS OFF | | 10-1 |



The factory setting (option) is shown in bold.

Press the Menu numbers.
(ex. Press 1, 1 for Date/Time)

—OR—

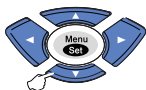

to select



to select

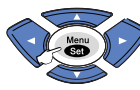

to accept

Stop/Exit



to exit

| Main Menu | Menu Selections | Options | Descriptions | Page |
|-------------------------------------|-----------------------|--|--|------|
| 8.REMOTE FAX OPT (FAX-T104 Only) | 1. FORWARD/ STORE | OFF FAX FORWARD FAX STORAGE | Sets the fax machine to forward fax messages or to store incoming faxes in the memory so you can retrieve them while you are away from your fax machine. | 8-2 |
| | 2. REMOTE ACCESS | ---* | You must set your own code for Remote Retrieval. | 8-3 |
| | 3. PRINT DOCUMENT | — | Print incoming faxes stored in the memory. | 5-8 |
| 8.SETUP TAD (FAX-T106 Only) | 1. VOICE STORE | ON EXT OFF | Sets the fax machine to store incoming voice messages. | 9-1 |
| | 2. FORWARD/ STORE | OFF FAX FORWARD FAX STORAGE | Sets the fax machine to forward fax messages, to store incoming faxes in the memory so you can retrieve them while you are away from your fax machine. | 9-2 |
| | 3. BACKUP PRINT | ON OFF | Automatically prints a copy of faxes received into memory. | 9-5 |
| | 4. OGM | TAD MESSAGE F/T MESSAGE | Play/Record or erase the outgoing message. | 9-3 |
| | 5. ICM MAX . TIME | 20-60 SEC (30) | Select the maximum length of incoming messages. | 9-6 |
| | 6. ICM REC. MONITR | ON OFF | Allows you to turn the speaker volume for voice messages as they come in on or off. | 9-7 |
| | 7. REMOTE ACCESS | ---* | You must set your own code for Remote Retrieval. | 9-8 |



The factory setting (option) is shown in bold.

Press the Menu numbers.
(ex. Press 1, 1 for Date/Time)

—OR—



to select



to select



to accept

Stop/Exit



to exit

| Main Menu | Menu Selections | Options | Descriptions | Page |
|------------------------------------|-----------------------------|---|--|------|
| 9.SETUP MELODY (FAX-T1 06 Only) | 1. RING PATTERN | SIGNAL MELODY1 MELODY2 MELODY3 MELODY4 | Selects ring pattern. | 4-6 |
| | 2. MUSIC ON HOLD | OFF MELODY1 MELODY2 MELODY3 MELODY4 | Select the melody type or turn the hold music off. | 4-6 |
| 0. MISCELLANEOUS | 1. TX LOCK | — | Prohibits most functions except receiving faxes. | 6-13 |
| | 2. COMPATIBILITY | NORMAL BASIC | If interference on your phone line interrupts your faxes, try the 'BASIC' setting. | 13-4 |
| | 3. CALLER ID (U.K. only) | ON OFF DISPLAY ID PRINT REPORT | View and dial back, or print a list of the last 30 Caller IDs stored in memory. | 5-10 |
| | 4. BT CALL SIGN (U.K. only) | ON OFF | Use with BT Call Sign. | 5-14 |



The factory setting (option) is shown in bold.

4 Initial Setup

Getting started

Setting the Date and Time

When the fax machine is not in use, it will display the date and time. If you set up the Station ID the date and time displayed by your fax machine will be printed on every fax you send. If there is a power failure, you may have to reset the date and time.

- 1 Press **Menu/Set**, **1**, **1**. 1 . DATE / TIME
- 2 Enter the last two digits of the year.
Press **Menu/Set**.
- 3 Enter two digits for the month.
Press **Menu/Set**.
(For example, enter 09 for September, or 10 for October.)
- 4 Enter two digits for the day.
Press **Menu/Set**.
(For example, enter 06.)
- 5 Enter the time in 24-Hour format.
Press **Menu/Set**.
(For example, enter 15:25 for 3:25 P.M.)
- 6 Press **Stop/Exit**.
The LCD now shows the date and time whenever the fax machine is in Standby mode.

Turning on Automatic Daylight Savings Time

You can set the fax machine to change automatically for Daylight Savings Time. It will reset itself forward one hour in the Spring and backward one hour in the Autumn. Make sure you have set the correct day and time in the `DATE/TIME` setting. The default setting is ON.

- 1 Press **Menu/Set**, **1**, **2**. 2 . AUTO DAYLIGHT
- 2 Press **▲** or **▼** to select ON (or OFF).
Press **Menu/Set**.
- 3 Press **Stop/Exit**.

Setting the Station ID

You should store your name or company name and fax number so they print on all fax pages that you send. The telephone number will appear only on cover pages and call back messages.

It is important that you enter the fax and telephone numbers in the internationally standardised format, i.e. in accordance with the following strict sequence:

- The “+” (plus) character (by pressing ✕ key)
- Your Country Code (e.g. “44” for the United Kingdom, “41” for Switzerland)
- Your local area code minus any leading “0” (“9” in Spain)
- A space
- Your number on the local exchange, using spaces to aid readability as appropriate.

As an example, if the fax machine is installed in the United Kingdom and the same line is to be used for both fax and voice calls, and your national telephone number is 0161 444 5555, then you must set the fax and telephone number parts of your station ID as: +44 161 444 5555.

1 Press **Menu/Set**, **1**, **3**.

3 . STATION ID

2 Enter your fax number (up to 20 digits).

Press **Menu/Set**.

You must enter a fax number to continue (up to 20 digits).



If you do not enter a fax number, you cannot enter any more information.

You can not enter a hyphen.

3 Enter your telephone number (up to 20 digits).

Press **Menu/Set**.

4 Use the dial pad to enter your name (up to 20 characters).

Press **Menu/Set**.

(See *Entering text* on page 4-3.)

5 Press **Stop/Exit**.

The LCD will show the date and time.



If the Station ID has already been programmed, the Station ID will ask you to press **1** to make a change or **2** to exit without changing the setting.

Entering text

When you are setting certain menu selections, such as the Station ID, you may need to type text into the fax machine. Most number keys have three or four letters printed on them. The keys for **0**, **#** and ***** do not have printed letters because they are used for special characters.

By pressing the appropriate dial pad key repeatedly, you can access the character you want.

| Press Key | one time | two times | three times | four times | five times |
|-----------|----------|-----------|-------------|------------|------------|
| 2 | A | B | C | 2 | A |
| 3 | D | E | F | 3 | D |
| 4 | G | H | I | 4 | G |
| 5 | J | K | L | 5 | J |
| 6 | M | N | O | 6 | M |
| 7 | P | Q | R | S | 7 |
| 8 | T | U | V | 8 | T |
| 9 | W | X | Y | Z | 9 |

Inserting spaces

To enter a space in the fax number, press ► once between numbers. To enter a space in the name, press ► twice between characters.

Making corrections

If you entered a letter incorrectly and want to change it, press ◀ to move the cursor under the incorrect character. Then press **Stop/Exit**. All the letters above and to the right of the cursor will be deleted. Re-enter the correct characters. You can also back up and type over incorrect letters.

Repeating letters

If you need to enter a character that is on the same key as the previous character, press ► to move the cursor to the right before you press the key again.

Special characters and symbols

Press *****, **#** or **0**, and then press ◀ or ► to move the cursor under the special character or symbol you want. Then press **Menu/Set** to select it.

| | | |
|----------------|-----|--|
| Press * | for | (space) ! " # \$ % & ' () * + , - . / € |
| Press # | for | : ; < = > ? @ [] ^ _ |
| Press 0 | for | Ä Ë Ö Ü À Ç È É 0 |

Setting the Beeper Volume

You can change the beeper volume. The default (factory) setting is **LOW**. When the beeper is on, the fax machine will beep when you press a key, make a mistake or after you send or receive a fax.

- 1 Press **Menu/Set**, **1**, **4**.

4 . BEEPER

(**LOW**, **HIGH** or **OFF**)

- 2 Press **▲** or **▼** to select your option.

Press **Menu/Set**.



- 3 Press **Stop/Exit**.

Setting the Speaker Volume

You can adjust the speaker volume.

- 1 For FAX-T104, lift the handset and press **Tel**.

For FAX- T106, press **Speaker Phone**.

- 2 Press  or  to adjust the volume level.



The LCD shows the setting you are choosing. Each key press changes the volume to the next setting. The new setting will remain until you change it again.

- 3 For FAX-T104, press **Tel**.

For FAX- T106, press **Speaker Phone**.





(FAX-T106 only)

- You can adjust the speaker volume using  or  while you are listening to your OGM (Outgoing Message) and ICMs (Incoming Messages).
- If you turn Incoming Recording Monitor to **OFF** (**Menu/Set**, **8**, **6**) the Speaker for screening calls will be disabled and you won't hear callers leaving messages. The volume for other operations can still be controlled using **◀** or **▶**.

Setting the Ring Volume

You can turn the ring off or you can select a ring volume level when your machine is idle (not being used).

Press  or  to adjust the volume level. Every time you press these keys, the fax machine will ring so you can hear the active setting as the LCD shows it. The volume changes with each key press. The new setting will stay until you change it again.

Setting the Phone Line Set

If you are connecting the fax machine to a line that features a PABX (PBX) or ISDN to send and receive faxes, it is also necessary to change the phone line type accordingly by completing the following steps.

- 1 Press **Menu/Set**, **1**, **5**.
- 2 Press **▲** or **▼** to select **PBX**, **ISDN**, (or **NORMAL**).
Press **Menu/Set**.
- 3 Press **Stop/Exit**.

5 . PHONE LINE SET

PABX and TRANSFER

The fax machine is initially set to be connected with PSTN (Public Switched Telephone Network) lines. However, many offices use a central telephone system or Private Automatic Branch Exchange (PABX). Your fax machine can be connected to most types of PABX. The fax machine's recall feature supports timed break recall only (TBR). TBR will work with most PABX systems allowing you to gain access to an outside line, or transfer calls to another extension. The feature works when the **R** key is pressed.



You can program an **R** keypress as part of a number stored in a One-Touch or Speed-Dial location. When programming the One-Touch or Speed-Dial number (**Menu/Set**, **6**, **1** or **6**, **2**) press **R** first (the screen displays "!"), then enter the telephone number. If you do this, you do not need to press **R** each time before you dial using a One-Touch or Speed-Dial location. (See *One-Touch dialling* on page 6-1 and *Speed-dialling* on page 6-1.)

However, if PABX is set to OFF, you can't use the One-Touch or Speed-Dial number that an **R** keypress is programmed into.

Setting Tone or Pulse dialling mode

Your fax machine comes set for Tone dialling service (multi-frequency). If you have Pulse dialling service (rotary), you need to change the dialling mode.

- 1 Press **Menu/Set**, **1**, **6**.
- 2 Press **▲** or **▼** to select **PULSE** (or **TONE**).
Press **Menu/Set**.
- 3 Press **Stop/Exit**.

6 . TONE / PULSE

Melody Settings (FAX-T106 only)

Setting the Ring Pattern

You can select a ring pattern from signal (regular ring pattern) or 4 types of melody.

The default setting is SIGNAL.

- 1 Press **Menu/Set, 9, 1.**
- 2 Press **▲** or **▼** to select
SIGNAL, MELODY1, MELODY2, MELODY3 or MELODY4 and
press **Menu/Set.**
- 3 Press **Stop/Exit.**

1.RING PATTERN



You can select a melody for the initial ring only. The F/T pseudo-ring will stay the same.

Setting the Music on Hold

You can select the music on hold. You can also set the music to OFF.

- 1 Press **Menu/Set, 9, 2.**
- 2 Press **▲** or **▼** to select MELODY1, MELODY2, MELODY3 or
MELODY4 or OFF.
- 3 Press **Menu/Set.**
- 4 Press **Stop/Exit.**

5 Setup Receive

Basic receiving operations

Choosing the Receive Mode

There are four different Receive Modes for the fax machine. You can choose the mode that best suits your needs.

| LCD | How it works | When to use it |
|---|---|---|
| FAX ONLY (automatic receive) | The fax machine automatically answers every call as a fax. | For dedicated fax lines. |
| FAX/TEL* (fax and telephone) | The fax machine controls the line and automatically answers every call. If the call is a fax it will receive the fax. If the call is not a fax it will ring (pseudo/double ring) for you to pick up the call. | Use this mode if you expect to receive lots of fax messages and few telephone calls. You cannot have an answering machine on the same line, even if it is on a separate wall socket/phone socket on the same line. You cannot use the telephone company's Call Minder in this mode. |
| TAD:ANSWER MACH. (with an external answering machine) (FAX-T104 only) | The external answering machine (TAD) automatically answers every call. Voice messages are stored on the external TAD. Fax messages are printed. | Use this mode if you have connected an external answering machine to your machine. The TAD setting works only with an external answering machine. Ring Delay and F/T Ring Time do not work in this setting. |
| MANUAL (manual receive) | You control the phone line and must answer every call yourself. | Use this mode if you do not receive many fax messages, with BT Call Sign, or if you are using a computer on the same line. If you answer and hear fax tones, wait until the machine takes over the call, then hang up. (See <i>Fax Detect</i> on page 5-4) |
| TAD:MSG MGR (FAX-T106 only)  ON | The fax machine automatically answers every call. The messages are stored in order on a first come first served basis. | Use this mode to record voice or fax messages into the machine's memory. (See <i>Message Manager</i> on page 9-1.) |

* In FAX/TEL mode you must set the RING DELAY and F/T RING TIME. If you have extension phones on the line, keep the RING DELAY set to 4 rings.

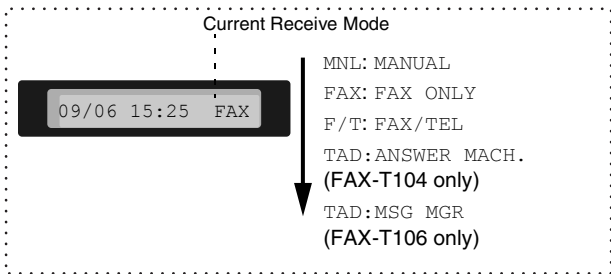

To select or change your Receive Mode

1 Press **Receive Mode**.

The LCD shows your current selection.

The options on FAX-T104 are:

FAX ONLY

FAX/TEL

TAD: ANSWER MACH.

MANUAL

The options on FAX-T106 are:

FAX ONLY

FAX/TEL

MANUAL

TAD: MSG MGR

Or, if TAD Mode is switched ON by pressing  (**Digital TAD** button), it overrides your

Receive Mode setting, so the display shows:

2 Continue to press **Receive Mode** until your new selection appears. After 2 seconds, the screen returns to the date and time display, along with your new Receive Mode setting.

 If you are changing the Receive Mode while in another operation, the screen returns to the current operation display.

Setting the Ring Delay

The Ring Delay sets the number of times the fax machine rings before it answers in FAX ONLY or FAX/TEL and TAD: MSG MGR modes. (FAX-T106 only)

1 Press **Menu/Set**, **2**, **1**.

If you have a FAX-T104, go to Step 3.

2 Press **▲** or **▼** to select RING DELAY, and press **Menu/Set**.

3 Press **▲** or **▼** to select how many times the line rings before the machine answers, and press **Menu/Set**.

4 Press **Stop/Exit**.

 (FAX-T106 only)

Toll Saver must be OFF to use the Ring Delay setting.

Setting the F/T Ring Time (FAX/TEL mode only)

If you set the Receive Mode to **FAX/TEL**, you'll need to decide how long the fax machine will signal you with its special pseudo/double-ring when you have a voice call. (If it's a fax call, the fax machine prints the fax.) This pseudo double ringing happens after the initial ringing from the phone company. Only the fax machine rings and no other phones on the same line will ring with the special pseudo/double-ring. However, you can still answer the call on any extension phone (in a separate phone socket) on the same line as the fax machine. (See *Operation from extension telephones* on page 5-6.)

- 1 Press **Menu/Set**, **2**, **2**. 2.F/T RING TIME
- 2 Press **▲** or **▼** to select how long the fax machine will ring to alert you that you have a voice call (20, 30, 40 or 70 seconds).
Press **Menu/Set**.
- 3 Press **Stop/Exit**.

 Even if the caller hangs up during the pseudo/double-ringing, the fax machine will continue to ring for the set time.

Recording the Fax/Tel Outgoing Announcement (F/T MESSAGE) (FAX-T106 only)

This is the announcement played by your machine (not an external TAD) when someone calls and your machine is set to **FAX/TEL** receive mode. Although callers hear your announcement, they cannot leave a message.

- 1 Press **Menu/Set**, **8**, **4**.
- 2 Press **▲** or **▼** to select **F/T MESSAGE**, and press **Menu/Set**.
- 3 Press **▲** or **▼** to select **RECORD MSG** and press **Menu/Set**, then pick up the handset to record a message (up to 20 seconds).
- 4 Replace the handset. Your announcement is played.
- 5 Press **Stop/Exit**.

 It is not necessary to have an outgoing message. The **F/T** mode will work fine without one. It is only to help the caller understand the status of your machine. (See *Erasing the Outgoing Message (OGM)* on page 9-3 for directions to erase the announcement.)

For example, you can leave a message that says:

“Hello, please wait, we are trying to connect you. If you wish to send a fax, please wait until you hear a fax tone and press the Start key, or, press * 5 1 (your three-digit fax receive code) and press the Start key.”

Fax Detect

When you use this feature, you don't have to press **Fax Start** or the Fax Receive Code * 5 1 when you answer a fax call and hear calling beeps. Just hold the handset and wait a few seconds. Selecting **ON** allows the fax machine to receive fax calls automatically, even if you lift the machine's handset or the handset of an extension or external phone. When you see **RECEIVE** on the LCD or when you hear "chirps" through the handset of an extension phone connected to another wall socket/phone socket, just replace the handset and the fax machine will do the rest. **SEMI** lets the fax machine receive the fax only if you've answered it at the fax machine.



■ If you have set this feature to **FAX DETECT:ON**, but your machine does not automatically connect a fax call when you lift an external or extension phone handset, press the Fax Receive Code * 5 1. At the machine lift the handset and then press **Fax Start**.

■ If you send faxes from a computer on the same phone line and the machine intercepts them, set this feature to **FAX DETECT:OFF**.

■ Selecting **FAX DETECT:OFF** means you'll have to activate the machine yourself by pressing **Fax Start**.

—OR—

Press * 5 1 on the external or extension phone if you are not at your machine.

- 1 Press **Menu/Set**, 2, 3.
- 2 Use ▲ or ▼ to select **ON**, **SEMI** or **OFF**.
Press **Menu/Set**.
- 3 Press **Stop/Exit**.

3 . FAX DETECT

Printing a reduced incoming fax (Auto Reduction)

If you choose **AUTO**, the fax machine automatically reduces an incoming fax to fit on one page of A4 size paper, regardless of the paper size of the document.

- 1 Press **Menu/Set**, 2, 5.
- 2 Use ▲ or ▼ to select **ON** (or **OFF**).
Press **Menu/Set**.
- 3 Press **Stop/Exit**.

5 . AUTO REDUCTION



■ If you receive faxes that are split on two pages, turn on this setting. If the document is too long, however, the fax machine may print it on two pages.

■ When Auto Reduction is turned on and an incoming document is smaller than your paper, no reduction will take place, and you will get the same size as the sender's document.

Reception into memory

As soon as the paper tray becomes empty during fax reception, the screen will display **CHECK PAPER**; please put some paper in the paper tray. (See Quick Setup Guide.)

If the Memory Receive is set to ON at this time...

If sufficient memory is available, the current fax reception will continue. Subsequent incoming faxes will also be stored into memory until the memory becomes full, following which no further incoming fax calls will be answered automatically. To print all the faxes stored in memory, insert paper into the paper tray.

If the Memory Receive is set to OFF at this time...

If sufficient memory is available, the current fax reception will continue and remaining pages will be stored in memory, subject to available memory. Subsequent incoming faxes will not be answered automatically until fresh paper is put in the paper tray.

1 Press **Menu/Set**, **2**, **6**.

6 . MEM . RECEIVE

2 Use **▲** or **▼** to select **ON** (or **OFF**).

Press **Menu/Set**.

3 Press **Stop/Exit**.

Receiving a fax at the end of a conversation

At the end of a conversation you can ask the other party to fax you information before you both hang up.

1 Ask the other party to place the document in their machine and to press **Start**. Tell the other party to wait until the fax machine sends receiving tones (chirps) before hanging up.

2 When you hear the other machine's CNG tones (beeps), press **Fax Start**.

The LCD shows:

RECEIVE

3 Replace the handset.

Advanced receiving operations

Operation from extension telephones

If you answer a fax call on an extension telephone, or an external telephone into the correct socket on the machine, you can make the fax machine take the call by using the Fax Receive Code.

When you press the Fax Receive Code * 5 1, the fax machine starts to receive a fax. (See *Fax Detect* on page 5-4.)

If the fax machine answers a voice call and pseudo/double-rings for you to take over, use the Telephone Answer Code # 5 1 to take the call at an extension phone.

(See *Setting the F/T Ring Time (FAX/TEL mode only)* on page 5-3.)

If you answer a call and no one is on the line, you should assume that you're receiving a manual fax.

- At an extension phone (on a separate telephone wall socket), press * 5 1, wait for fax-receiving tones (chirps), and then hang up.
- At an external phone (connected to the correct socket on the machine), press * 5 1 and wait for the phone to be disconnected before you hang up (the LCD shows **RECEIVE**).

Your caller will have to press the Start key to send the fax.

For FAX/TEL mode only

When the fax machine is in FAX/TEL mode, it will use the F/T Ring Time (pseudo/double-ringing) to alert you to pick up a voice call.

If you're at an extension or external phone, you'll need to lift the handset during the F/T Ring Time and then press # 5 1 between the double rings. If no one is on the line, or if someone wants to send you a fax, send the call back to the fax machine by pressing * 5 1.

Remote Call Transfer

In order to use this feature, you should first set **REMOTE CODE** to **ON**. (See *Changing the remote codes* on page 5-7.)

You can use the Remote Call Transfer feature to transfer a voice call received on a remote DECT cordless phone externally connected to the fax machine. (See *Connecting an external telephone* on page 1-9.) You can transfer an incoming voice call to your fax machine, but you cannot transfer a call from your fax machine to your DECT phone.

To transfer a telephone call to the fax machine

When you pick up the voice call at the remote DECT cordless phone and would like to transfer it to the fax machine,

- 1 Press DECT Activation Voice Code * **8 1** at remote cordless phone.
- 2 The fax machine rings (pseudo-ring same as current F/T ring) and the display shows "PICK UP PHONE".
- 3 Pick up the handset and press **Tel** (FAX-T104 only).

—OR—

Just press **Speaker Phone** (FAX-T106 only) at the fax machine in order to transfer the voice call to the fax machine.



Don't hang up the call from the cordless phone until the voice call has been transferred to the fax machine. You will know when this is because you will no longer be able to hear or talk to the caller via the cordless phone. If you do not wait until this point before hanging up from the cordless phone, the call will be lost.

If nobody answers at the fax machine, pseudo-ringing stops after 30 seconds. In that case, it may still be possible to speak with the caller from the cordless phone. Speech between the fax machine and the cordless phone (as with an intercom system) is not possible.

Changing the remote codes

Remote Codes might not work with some telephone systems. The preset Fax Receive Code is * **5 1**. The preset Telephone Answer Code is # **5 1**. The preset Activation Voice Code * **8 1**.



If you are always disconnected when accessing your external TAD remotely, try changing the Fax Receive Code, Telephone Answer Code, or Activation Voice Code to other three-digit codes using numbers 0-9, * or #.

- 1 Press **Menu/Set**, **2**, **4**.
- 2 Press **▲** or **▼** to select **ON** (or **OFF**).
Press **Menu/Set**.
- 3 Enter the new Fax Receive Code.
Press **Menu/Set**.
- 4 Enter the new Telephone Answer Code.
Press **Menu/Set**.
- 5 Enter the new Activation Voice Code.
Press **Menu/Set**.
- 6 Press **Stop/Exit**.

4.REMOTE CODE

Printing a fax from the memory (FAX-T104 only)

If you have selected FAX Forwarding or Fax Storage (**Menu/Set, 8, 1**) you can still print a fax from the memory when you are at the fax machine. (See *Setting Fax Storage* on page 8-2.)

- 1 Press **Menu/Set, 8, 3**.
- 2 Press **Fax Start**.
- 3 After printing has finished, press **Stop/Exit**.

3 . PRINT DOCUMENT

Polling

Polling is the process of retrieving faxes from another fax machine. You can use the fax machine to 'poll' other machines, or you can have someone poll the fax machine.

Everyone who is involved in Polling needs to set up their fax machines for Polling. When someone polls the fax machine to receive a fax, they pay for the call. If you poll someone's fax machine to receive a fax, you pay for the call.



Some fax machines do not respond to the Polling feature.

Secure Polling

Secure Polling is a way to keep your documents and others from falling into the wrong hands while the machine is set up for polling. You can use Secure Polling only with another Brother fax machine. Anyone who polls to receive a fax must enter the polling secure code.

Setting up Polling Receive (Standard)

Polling Receive is when you call another fax machine to receive a fax from it.

- 1 Press **Menu/Set, 2, 7**.
- 2 Press **▲** or **▼** to select
STANDARD.
Press **Menu/Set**.
- 3 Enter the fax number you are polling.
Press **Fax Start**.

7 . POLLING RX

Setup for Polling Receive with Secure Code

You need to make sure you are using the same secure code as the other party.

- 1 Press **Menu/Set, 2, 7**.
- 2 Press **▲** or **▼** to select **SECURE**.
Press **Menu/Set**.
- 3 Enter a four-digit secure code.
This is the same as the security code of the fax machine you are polling.
- 4 Press **Menu/Set**.
- 5 Enter the fax number you are polling.
- 6 Press **Fax Start**.

Setup Delayed Polling Receive

You can set the machine to begin Polling Receive at a later time.

- 1 Press **Menu/Set**, **2**, **7**.
- 2 Press **▲** or **▼** to select **TIMER**.
Press **Menu/Set**.
- 3 The screen prompts you to enter the time you want to begin polling.
- 4 Enter the time (in 24-hour format) you want to begin polling.
For example, enter 21:45 for 9:45 PM.
- 5 Press **Menu/Set**.
- 6 Enter the fax number you are polling.
- 7 Press **Fax Start**.

The machine makes the polling call at the time you entered.



You can set up only one Delayed Polling.

Sequential Polling

The machine can request documents from several fax units in a single operation. You just specify several destinations in Step 4. Afterwards, a Sequential Polling Report will be printed.

- 1 Press **Menu/Set**, **2**, **7**.
- 2 Press **▲** or **▼** to choose **STANDARD**, **SECURE** or **TIMER**.
Press **Menu/Set** when the screen displays the setting you want.
- 3 If you selected **STANDARD**, go to Step 4.
 - If you selected **SECURE**, enter a four-digit number and press **Menu/Set**, and then go to Step 4.
 - If you selected **TIMER**, enter the time (in 24-hour format) you want to begin polling and press **Menu/Set**, and then go to Step 4.
- 4 Specify the destination fax machines, which you wish to poll by using One-Touch, Speed-Dial, Search or a Group. For example, for One-Touch **3** and Speed-Dial location **09**, press One-Touch Dial key **3**, **Search/Mute**, **#** and **09**. (See *How to dial* on page 6-1.)
- 5 Press **Fax Start**.
- 6 The machine polls each number or group number in turn for a document.

POLLING RX

POLLING : STANDARD

Telephone Services

Your fax machine supports the Caller ID and BT Call Sign (For U.K. only) telephone services offered by some telephone companies.

Caller ID (Caller IDentification) (U.K. only)

Caller ID is a telephone service that allows the subscriber to see a display of the caller's phone number as the telephone rings. It is a fast way to screen your calls. You can respond quickly to calls you missed, because Caller IDs are received and stored in your machine's memory. In addition to the standard Caller ID features, you can select a Caller ID and have your machine dial the number for you.



- You will need to speak to your telephone company if you want to apply for the Caller ID Service.

- To PABX Users:

Calling line identification signals are not generally delivered to your Brother fax machine if it is connected behind a private automatic branch exchange (PABX) system or other call routing device.

Advantages of Caller ID

For Business

All businesses profit from a quicker response to customer calls.

At Home

Residential customers can protect themselves from unwanted calls by seeing the callers name or number before they answer.

Set the Caller ID to ON

If you have BT Caller ID on your line, then this function should be set to **ON** to display the caller's phone number on the fax LCD as the telephone rings.

- 1** Press **Menu/Set, 0, 3**.
- 2** Press **▲** or **▼** to choose **ON** (or **OFF**).
Press **Menu/Set**.
- 3** Press **Stop/Exit**.

3 . CALLER ID

How Does the Caller ID Work?

The Caller ID Appears on the Display When Your Telephone Rings

As your telephone rings, the screen displays the caller's phone number. If the caller's name is stored in your machine as a Speed-Dial, or One-Touch dial, the caller's name will be displayed. Once you pick up the handset, the caller's ID disappears.



- If # UNAVAILABLE appears on the display, it means that the call came from outside your caller ID service area.
- If # WITHHELD appears on the display, it means the caller intentionally blocked the transmission of his/her ID.
- If no caller ID was transmitted to your fax machine, PICK UP PHONE will remain on the display.

The Caller ID is Stored in Your Machine's Memory

The machine can store a maximum of the last 30 incoming caller IDs in the memory, along with the time and date of reception. The 31st call will cause the oldest ID to be erased.

The Caller ID information stored in the memory can be used for the following.

■ Selecting a Caller ID from the Memory for Call Reply.

You can scroll through the Caller IDs on the display and select one for your machine to dial. (See *Selecting a Caller ID from the Memory for Call Reply* on page 5-12.)

■ Printing the Caller ID List.

You can review calls you received by checking the Caller IDs in memory. This report will list the Date, Time, Phone Number (Caller ID), and type of call (Comment).



Please set up the number of rings to more than 02 in the Ring Delay (See *Setting the Ring Delay* on page 5-2) before you use the Caller ID. If you set up the number of rings to 01, you cannot receive the Caller ID.

Selecting a Caller ID from the Memory for Call Reply

You can display the caller IDs currently stored in the memory and select the number of the caller you want your machine to dial. Call Reply is a convenient feature whereby your Brother fax can dial back a voice/fax call “on-hook” to the opposite party associated with a Caller ID number which has been captured into memory. This saves you from having to copy and dial back to that number manually.

1 Press **Menu/Set, 0, 3**.

2 Press **▲** or **▼** to select
DISPLAY ID, and press
Menu/Set.

DISPLAY ID

The caller ID of the last call will appear on the display. If no ID is stored, the beeper will sound and NO CALLER ID will appear on the display.

3 Press **▲** or **▼** to scroll through the Caller IDs in the memory, and press **Menu/Set** to automatically dial the Caller ID number. Wait until the screen prompts you to press the **Fax Start** key.

4 Press **Fax Start**.

DIALLING

5 If you wish to send a fax, insert
a document into the ADF.

TELEPHONE

Then press **Fax Start**.

To cancel the Call Reply (for example, when you selected the Wrong Caller ID), simply press **Stop/Exit** and begin again; the Caller ID will not be lost.

To Activate Certain Network Services When Using Call Reply



You may wish (in order to activate certain network services), to insert a special prefix to be dialed in front of the Caller ID number when using the Call Reply feature.

For example, - Your outgoing Caller ID withheld

The required prefix, typically three to six digits (including # and * symbols) in length, may be inserted after displaying the desired Caller ID in step 3 on the previous page. (You can enter the prefix up to 20 digits on the machine.) The complete number string including the prefix will then be dialed by pressing **Fax Start**.

Select the desired Caller ID, wait 2 seconds until you see the date and time the Caller ID was received.

25)09/11 15:25

DIAL:PRESS START

Enter the prefix by using number keys up to 20 digits.

- The display will be cleared when you press any of the number keys.
- To cancel the prefix (such as when you entered the wrong number), simply press **Stop/Exit**.
- The display will return to the desired Caller ID you selected.
- If you press **Stop/Exit** again, the machine will return to the current date and time display. You are no longer in the call reply mode.
- Any problems or queries in using network services should be raised in the first instance with your network operator(s).
- With Call Reply, automatic redial does not function in cases where the called party is busy or doesn't answer.

Clearing the Caller ID Stored in Memory (FAX-T106 only)

For the effective use of the memory, it is recommended that you should clear the Caller ID stored into memory by pressing **Erase** when the screen displays the number.

Printing Caller ID List

- 1 Press **Menu/Set**, **0**, **3**.
- 2 Press **▲** or **▼** to select **PRINT REPORT**, and press **Menu/Set**.
- 3 Press **Stop/Exit**.

BT Call Sign (U.K. only)

This fax machine feature lets you use the BT Call Sign subscriber service which allows you to have at least two separate telephone numbers on one phone line. Each phone number has its own distinctive ringing pattern, so you know which phone number is ringing. This is one way you can have a separate phone number for your machine.

Your fax machine has a BT Call Sign compatible distinctive ringing function, allowing you to dedicate a second phone number (on the same phone line) just for receiving faxes.

 You can switch BT Call Sign off temporarily, then turn it back on. When you get a new fax number, make sure you reset this function. This fax machine will automatically answer incoming calls that use your new fax number.

 When you set the BT Call Sign feature to ON, the receive mode is set to **MANUAL** automatically. You cannot change the receive mode to any other mode while the BT Call Sign feature is set to on.

(If you are using FAX-T106 and set TAD mode, the machine stays in **TAD:MSG MGR** mode.)

To enable the machine to work with BT Call Sign (Only with your external phone)

1 Press **Menu/Set**, **0**, **4**.

The screen displays the current setting of this feature.

2 Press **▲** or **▼** to select **ON** (or **OFF**).

Press **Menu/Set**.

3 Press **Stop/Exit**.

 If you turn off the BT Call Sign feature on your fax machine, the receive mode stays **MANUAL**. You need to set the receive mode again.

6 Setup Send

How to dial

You can dial in any of the following ways.

Manual dialling

Press all of the digits of the phone or fax number.



One-Touch dialling

Press the One-Touch key of the location you want to call.
(See *Storing One-Touch Dial numbers* on page 7-1.)

Speed-dialling

Press **Search/Mute**, #, and then the two digit Speed-Dial number.
(See *Storing Speed-Dial numbers* on page 7-2.)

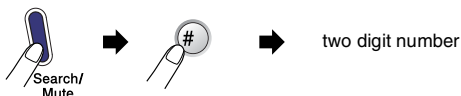

If the LCD shows **NOT REGISTERED** when you enter the Speed-Dial number, a number has not been stored for it.

Search

You can search for names you have stored in One-Touch and Speed-Dial memories. Press **Search/Mute** and the navigation keys (◀ or ▶) to search.
(See *Storing One-Touch Dial numbers* on page 7-1 and *Storing Speed-Dial numbers* on page 7-2.)

 To search alphabetically, you can use the dial pad to enter the first letter of the name you are looking for.

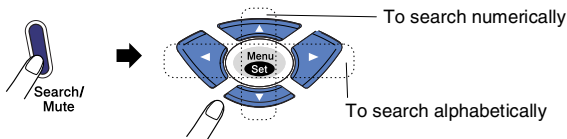

Fax Redial

If you are sending a fax manually and the line is busy, press **Redial/Pause**, and then press **Fax Start** to try again. If you want to make a second call to the last number dialed, you can save time by pressing **Redial/Pause** and **Fax Start**.

Redial/Pause only works if you dialed from the control panel.

If you are sending a fax automatically and the line is busy, the fax machine will automatically redial three times at five minute intervals.

How to fax

Automatic transmission

This is the easiest way to send a fax. Documents must be between 150 and 600 mm long and between 148 and 216 mm wide, regardless of the paper width.

IMPORTANT: Do not pick up the handset or press **Speaker Phone** (FAX-T106 only).

- 1 Insert the document face down, top edge first in the Automatic Document Feeder (ADF).
- 2 Adjust the paper guides to fit the width of your document.

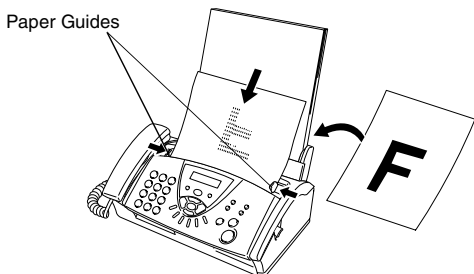

- 3 Enter the fax number using One-Touch, Speed-Dial, Search or the dial pad. (See *One-Touch dialling* on page 6-1, *Speed-dialling*, page 6-1 and *Search* on page 6-1.)
- 4 Press **Fax Start**.

- ⊘ Do not use paper that is curled, wrinkled, folded, ripped, stapled, paper clipped, pasted, or taped.
Do not use cardboard, newspaper or fabric.

-  The ADF can hold up to 10 pages, feeding each one individually through the fax machine. Use standard 64 g/m² - 90 g/m² paper when using the ADF; if you are using heavier paper, feed each sheet individually to prevent paper jams.

Manual transmission

Manual transmission lets you hear the dialling, ringing and fax-receiving tones while sending a fax.

- 1 Insert the document face down in the ADF.
- 2 Pick up the handset and listen for a dial tone.

—OR—

Press **Speaker Phone** (FAX-T106 only) and listen for a dial tone.

- 3 Enter the fax number you want to call. (You can enter the digits using the dial pad, or you can enter a One-Touch or Speed-Dial number, or you can call using **Search/Mute**.) (See *How to dial* on page 6-1.)

- 4 When you hear the fax tone, press **Fax Start**.

A rectangular button with the word "SEND" in capital letters.

- 5 If you pick up the handset, hang up.

Sending a fax at the end of a conversation

At the end of a conversation you can send a fax to the other party before you both hang up.

- 1 Ask the other party to wait for fax tones (beeps) and then to press Start before hanging up.

- 2 Insert the document face down in the ADF.

Press **Fax Start**.

The LCD shows:

A rectangular button with the word "SEND" in capital letters.

- 3 Replace the handset.

Basic sending operations

Sending faxes using multiple settings

When you send a fax you can choose any combination of these settings such as contrast, resolution, overseas mode, delayed fax timer, polling transmission or memory transmission.

After each setting is accepted, the LCD will ask if you want to enter more settings:

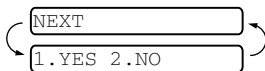

Press **1** to select more settings. The LCD will return to the **SETUP SEND** menu.

—OR—

Press **2** if you have finished choosing settings and go to the next step.

Contrast

If your document is very light or very dark, you may want to set the contrast.

Use **LIGHT** to make the document darker.

Use **DARK** to make the document lighter.

1 Insert the document face down in the ADF.

2 Press **Menu/Set**, **3**, **3**.

3 . CONTRAST

3 Press **▲** or **▼** to select **AUTO**, **LIGHT** or **DARK**.

Press **Menu/Set**.

4 Press **1** if you want to choose more settings and the LCD will return to the **SETUP SEND** menu.

ACCEPTED

NEXT

1 . YES 2 . NO

—**OR**—

Press **2** if you have finished choosing settings for this page, and then go to Step 5.

5 Enter a fax number.

6 Press **Fax Start** to send the fax.

The fax machine starts scanning the first page.

Fax resolution

When you have an document in the ADF you can use the **Resolution** key to change the setting temporarily (for this fax only). Press **Resolution** repeatedly until the LCD shows the setting you want.

STANDARD — Suitable for most typed documents.

FINE — Good for small print and transmits a little slower than Standard resolution.

S . FINE — Good for small print or artwork and transmits slower than Fine resolution.

PHOTO — Use when the document has varying shades of gray or is a photograph. This has the slowest transmission time.

Multiple Resolution Transmission

Use this feature to select separate resolution settings for each page of the fax you are sending. This could be useful if you are sending a fax with photos and text, or some pages with small print and others with larger print. Resolution settings return to **STANDARD** after the fax is sent.

- 1 Insert the document face down in the ADF.
- 2 Press **Menu/Set**, **3**, **4**.
- 3 Use **▲** or **▼** to select the resolution for page 1.

Press **Menu/Set**.

- 4 Repeat Step 2 for each page. Press **Stop/Exit** when you are finished. The screen displays:

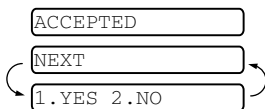

- 5 Press **1** if you want to select additional settings. The display returns to the **SETUP SEND** menu.

—OR—

Press **2** if you are finished choosing settings, and go to Step 6. The screen prompts you to enter the fax number you want to call.

- 6 Enter the fax number, and press **Fax Start**.

Cancelling a fax in progress

If you want to cancel a fax, while the fax machine is scanning, dialling or sending it, press **Stop/Exit**.

Cancelling a scheduled job

You can cancel a fax job that is stored and waiting in memory.

- 1 Press **Menu/Set**, **4**.
Any jobs that are waiting will appear on the LCD.
- 2 If you have more than one job waiting, press **▲** or **▼** to select the job you want to cancel. Press **Menu/Set**.

The diagram shows a single-line LCD screen displaying "4.CANCEL JOB".

—OR—

If you only have one job waiting, go to Step 3.

- 3 Press **1** to cancel.
—OR—
Press **2** to exit without cancelling. To cancel another job go to Step 2.

- 4 Press **Stop/Exit**.

Advanced sending operations

Composing the electronic Cover Page

The cover page is sent to the receiving party's machine. Your cover page includes the name or number stored in the One-Touch or Speed-Dial memory. If you are dialling manually, the name is left blank.

The cover page shows your Station ID, and the number of pages you are sending. If you have **COVERPG SETUP** set to **ON** (See *Send a cover page for all faxes* on page 6-7), the number of pages is left blank.

You can select a comment to include on your cover page.

1. COMMENT OFF
2. PLEASE CALL
3. URGENT
4. CONFIDENTIAL

Instead of using one of the preset comments, you can enter two personal messages of your own, up to 27 characters. (See *Entering text* on page 4-3.)

5. (USER DEFINED)
6. (USER DEFINED)

Most of the **SETUP SEND** settings are temporary to allow you to make changes for each fax you send. However when you set up your Cover Page and Cover Page Comments, you are changing the default settings so they will be available while faxing.

Composing your own comments

- 1 Press **Menu/Set**, **3**, **2**.

The screen displays:

2. COVERPAGE NOTE

- 2 Use **▲** or **▼** to choose position 5 or 6 for your own comment.

Press **Menu/Set**.

- 3 Use the dial pad to enter your customized comment. (See *Entering text* on page 4-3.)

- 4 Press **Menu/Set**.

The screen displays:

ACCEPTED

- 5 Press **1** if you want to choose more settings. The display returns to the **SETUP SEND** menu.

NEXT

1. YES 2. NO

—OR—

Press **2** to exit.

Cover page for next fax only

This feature does not work unless you have set up the Station ID. (See *Setting the Station ID* on page 4-2.)

If you only want to send a cover page with a particular fax, this cover page will include the number of pages in your document.

- 1 Insert the document face down in the ADF.
- 2 Press **Menu/Set**, **3**, **1**. 
- 3 When the LCD shows NEXT FAX ONLY, press **Menu/Set**.
- 4 Press **▲** or **▼** to select NEXT FAX:ON (or NEXT FAX:OFF), and press **Menu/Set**.
- 5 Press **▲** or **▼** to select one of the standard or your own comments.
- 6 Press **Menu/Set**.
- 7 Enter two digits to show the number of pages you are sending. (Enter **00** to leave the number of pages blank.) If you have made a mistake, press **◀** to back up and re-enter the number of pages.
- 8 Press **Menu/Set**.
- 9 Press **1** if you want to choose more settings. The LCD returns to the SETUP SEND menu.
—OR—
Press **2** if you have finished choosing settings.
- 10 Enter the fax number you are calling and then press **Fax Start**.

Send a cover page for all faxes

Make sure you have set up the Station ID before continuing. This feature does not work without the Station ID. (See *Setting the Station ID* on page 4-2.)

You can set your machine to send a cover page whenever you send a fax. The number of pages in your fax is not included when you use this setting.

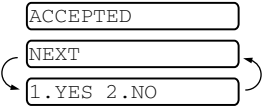
- 1 Press **Menu/Set**, **3**, **1**. 
- 2 Press **▲** or **▼** to select ON (or OFF). (If you select ON, a cover page is always sent when you send a fax.)
- 3 Press **Menu/Set**.
- 4 If you selected ON, press **▲** or **▼** to select one of the standard or your own comments.
- 5 Press **Menu/Set** when the screen displays your selection. The screen displays:

- 6 Press **1** if you want to choose more settings. The LCD returns to the SETUP SEND menu.
—OR—
Press **2** to exit if you have finished choosing settings.

Using a printed Cover Page

If you prefer using a printed cover page that you can write on, you can print the sample page and attach it to your fax.

- 1 Press **Menu/Set, 3, 1.**
- 2 Press **▲** or **▼** to select
PRINT SAMPLE.
Press **Menu/Set.**

1. COVERPG SETUP

Broadcasting

Using the numbers you have stored in Groups, One-Touch and Speed-Dial memory, you can “Broadcast” faxes automatically to a maximum of 104 different locations in a few simple steps.

You must set MEMORY TX, either ON or NEXT FAX ONLY.

After the Broadcast is completed, a Broadcast Report will be printed automatically to let you know the results.

- 1 Insert the document face down in the ADF.
- 2 Press **Menu/Set, 3, 9** to select ON for Memory Transmission. (See *Memory Transmission* on page 6-12.)
- 3 Press **Menu/Set.**
- 4 Enter the One-Touch and Speed-Dial numbers (one after the other), Search numbers or a Group number you have stored.
- 5 Press **Fax Start.** The fax machine stores the document in memory, and then transmits it to all the numbers you entered. If the line is busy, your machine will redial.



- Press **Stop/Exit** during transmission to cancel the current fax Broadcast.
- To cancel all locations, press **Menu/Set, 4.** (See *Cancelling a scheduled job* on page 6-5.)
- To turn Memory Transmission back off, after the Broadcast has finished go to Step 2 and select OFF.

Overseas Mode

If you are having difficulty sending a fax overseas due to possible interference on the phone line, we recommend that you turn on the Overseas Mode. After you send a fax using this feature, the feature will turn itself off.

- 1 Insert the document face down in the ADF.
- 2 Press **Menu/Set, 3, 5.**
- 3 Press **▲** or **▼** to select ON (or OFF).
Press **Menu/Set.**
- 4 Press **1** if you want to choose more settings and the LCD will return to the SETUP SEND menu.
—OR—
Press **2** if you have finished choosing settings, and then go to Step 5.
- 5 Enter the fax number you're calling.
- 6 Press **Fax Start.**

5. OVERSEAS MODE

Call Reservation

You can send a fax and let the other party know that you want to speak to him after the fax transmission is completed. The other fax machine will ring as if it was receiving a telephone call; if the other party picks up the handset, your machine will ring. To have a conversation, lift the handset.

If you set Call Reservation and Call Back message to **ON**, your machine leaves a message if the other party does not answer.

- 1 Insert the document face down in the ADF.
- 2 Press **Menu/Set**, **3**, **6**. 6 . CALL RESERVE
The screen displays the current setting for Call Reservation.
- 3 Press **▲** or **▼** to select **ON** (or **OFF**).
Press **Menu/Set**.
- 4 If you set Call Reservation to **ON**, the LCD shows the current setting for Call Back Message.
Press **▲** or **▼** to select **ON** (or **OFF**).
Press **Menu/Set**.
- 5 Press **1** if you want to select additional settings. The display returns to the **SETUP SEND** menu.
—OR—
Press **2** if you are finished choosing settings, and go to Step 6.
- 6 Enter the fax number, and press **Fax Start**.
- 7 If you've set Call Reservation to **ON**, pick up your handset if your machine rings.



You cannot use auto redial with Call Reservation. You cannot use Call Reservation with Delayed Transmission or with Polling. You must register your Station ID to set Call Back Message to **ON**.

Print Sample Call Back Message

- 1 Press **Menu/Set**, **3**, **6**. 6 . CALL RESERVE
- 2 Press **▲** or **▼** to select **PRINT SAMPLE**.
Press **Menu/Set**.

Delayed Fax

Depending on the size of the data, you can use this menu setting to send up to 3 faxes at later times within the next 24 hours.

- 1 Insert the document face down in the ADF.
- 2 Press **Menu/Set**, **3**, **7**. 7 . DELAYED FAX
- 3 Enter the time you want the fax to be sent (in 24-hour format).
Press **Menu/Set**.
(For example, enter 19:45 for 7:45 P.M.)
- 4 Press **1** if you want to leave the document in the ADF. 1 . DOC 2 . MEMORY
—OR—
Press **2** to scan the document into the memory.
- 5 Press **1** if you want to choose more settings and the LCD will return to the **SETUP SEND** menu.
—OR—
Press **2** if you have finished choosing settings, and then go to Step 6.
- 6 Enter the fax number.
- 7 Press **Fax Start**. The fax machine will wait until the time you have entered to send the fax.



- The number of pages you can scan into the memory depends on the amount of data that is printed on each page.
- If you press **2** in Step 4, the scanned document data will be stored until you delete the fax in memory by using the **Cancelling a Job** menu setting.

Setting up Polled Transmit (Standard)

Polled Transmit is when you set up the fax machine to wait with a document so another fax machine can call and retrieve it.

1 Insert the document face down in the ADF.

2 Press **Menu/Set**, **3**, **8**.

8 . POLLED TX

3 Press **▲** or **▼** to choose
STANDARD.

POLLING : STANDARD

Press **Menu/Set**.

4 Press **1** if you want to leave the
document in the ADF.

1 . DOC 2 . MEMORY

—OR—

Press **2** to scan the document into the memory.

5 Press **1** if you want to choose more settings and the LCD will
return to the **SETUP SEND** menu.

—OR—

Press **2** if you have finished choosing settings, and go to
step 6.

6 Press **Fax Start**.



■ If you pressed **1** in Step 4, the document remains in the ADF until your fax machine is polled. If you must use your fax machine before the polled Transmit occur, you can “interrupt” it to send another fax. (See *Interrupting Delayed Fax and Polled Transmit jobs* on page 6-13.) The document in the ADF can only be polled once.

■ If you pressed **2** in Step 4, the document will be stored in the memory and can be retrieved from any other fax machine until you delete the fax in memory by using the **Cancelling a Job** menu setting.

Setup for Polling Transmit with Secure Code

When you choose **POLLING : SECURE**, anyone who polls your machine must enter the polling secure code.

1 Insert the document face down in the ADF.

2 Press **Menu/Set**, **3**, **8**.

8 . POLLED TX

3 Press **▲** or **▼** to choose
SECURE, and press **Menu/Set**.

4 Enter a four-digit number, and press **Menu/Set**.

5 Press **1** to select **DOC** if you want your machine to scan the
printed document at the time it is polled.

—OR—

Press **2** to select **MEMORY** to
scan the document into
memory.

1 . DOC 2 . MEMORY

- 6 Press **1** if you want to select additional settings. The display returns to the **SETUP SEND** menu.
—OR—
Press **2** if you have finished choosing settings and go to Step 7.
- 7 Press **Fax Start** and wait for the fax to be polled.

Secure Polling

Secure Polling is a way to keep your documents from “falling into the wrong hands” while the fax machine is set up for polling. You can use Secure Polling only with another Brother fax machine. Your four-digit ID number must be entered on the fax machine that polls for your documents.



Some machines do not respond to the polling function.

Memory Transmission

This feature allows the fax machine to scan a fax into its memory and send it as soon as the scan is complete. This way, you don't have to wait for the entire fax to be transmitted before you retrieve your document.

- 1 Insert the document face down in the ADF.

- 2 Press **Menu/Set**, **3**, **9**.

- 3 To change the default setting, press **▲** or **▼** to select **ON** (or **OFF**).

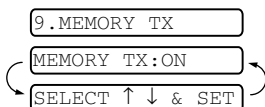

Press **Menu/Set**.

Go to Step 5.

—OR—

For the next fax transmission only, press **▲** or **▼** to select **NEXT FAX ONLY**.

Press **Menu/Set**.

- 4 For the next fax only, press **▲** or **▼** to select **ON** (or **OFF**).
Press **Menu/Set**.
- 5 Press **1** to choose more settings. The LCD returns to the **SETUP SEND** menu.

—OR—

Press **2** if you have finished choosing settings and go to Step 6.

- 6 Enter fax number and press **Fax Start**.

Out of Memory message

If you get an **OUT OF MEMORY** message while scanning the first page of a fax, press **Stop/Exit** to cancel the scan. If you get an **OUT OF MEMORY** message while scanning a subsequent page, you will have the option to press **Fax Start** to send the pages scanned so far, or to press **Stop/Exit** to cancel the operation.



If the faxes you send are typically very large or detailed, you may get **OUT OF MEMORY** errors frequently. If this happens, change the Memory Transmission setting back to **OFF**.

Interrupting Delayed Fax and Polled Transmit jobs

Even if you have your machine set to send a fax later, or if you have it set to be polled, you can interrupt the scheduled job to send a fax or make a copy now. However, you cannot use automatic redial or the Menu mode.

- 1 Press **Menu/Set, 5**.
- 2 Wait 2 seconds, then remove the documents that are waiting in the ADF.
- 3 Insert the document you want to send now in the ADF.
- 4 Enter the number for the fax you want to send now, and press **Fax Start**.
- 5 After the transmission is finished, return the first document to the ADF.
- 6 Press **Menu/Set, 5** to restore the Delayed Fax or Polled Transmit.

5 . INTERRUPT



If you set Delayed Fax or Polled Transmit using the memory (that is, if you have already scanned the document into your machine's memory and will send it from there), you don't have to interrupt to send a fax or make a copy.

TX Lock System

TX Lock lets you prevent unauthorised access to the fax machine. While TX Lock is **ON**, the following operations are available:

- Receiving faxes
- Answering calls
- Fax Forwarding (If Fax Forwarding was already **ON**.)
- Remote Retrieval (If Fax Storage was already **ON**.)

While TX Lock is **ON** the following operations are **NOT** available:

- Sending faxes
- Copy



You will not be able to continue to schedule Delayed Faxes or Polling jobs. However, any pre-scheduled Delayed Faxes will be sent when you turn TX Lock **ON**, so they won't be lost.

If you have selected Fax Forwarding or Fax Storage (For FAX-T104: **Menu/Set, 8, 1** or for FAX-T106: **Menu/Set, 8, 2**) before you turn TX Lock **On**, then Fax Forwarding and Remote Retrieval will continue to work.



To print the faxes in memory, turn TX Lock **OFF**.

Setting up the password

 If you forget the TX Lock password, please contact your Brother dealer or Brother for assistance.

- 1 Press **Menu/Set**, **0**, **1**.
- 2 Enter a 4-digit number for the password.
Press **Menu/Set**.
- 3 If the LCD shows `VERIFY :`, re-enter the password.
Press **Menu/Set**.

Changing the TX Lock password

- 1 Press **Menu/Set**, **0**, **1**.
- 2 Press **▲** or **▼** to select `SET PASSWORD`.
Press **Menu/Set**.
- 3 Enter a 4-digit number for the current password.
Press **Menu/Set**.
- 4 Enter a 4-digit number for a new password.
Press **Menu/Set**.
- 5 If the LCD shows `VERIFY :XXXX`, re-enter the password.
Press **Menu/Set**.

Turning TX Lock on

- 1 Press **Menu/Set**, **0**, **1**.
- 2 Press **▲** or **▼** to select `SET TX LOCK`.
Press **Menu/Set**.
- 3 Enter the registered 4-digit password.
Press **Menu/Set**.
The machine goes offline and the LCD shows
`TX LOCK MODE`.

Turning TX Lock off

- 1 Press **Menu/Set**.
- 2 Enter the registered 4-digit password.
Press **Menu/Set**.
TX lock is automatically turned off.

 If you enter the wrong Password, the LCD shows `WRONG PASSWORD` and stays offline. The machine will stay in TX Lock Mode until the registered password is entered.

7 Quick-Dial numbers and dialling options

Storing numbers for easy dialling

You can set up the fax machine to do following types of easy dialling: One-Touch, Speed-Dial and Groups for Broadcasting faxes. When you dial a quick-dial number, the LCD shows the name, if you stored it, or the number.



If you lose electrical power, the quick-dial numbers that are in the memory will not be lost.

Storing One-Touch Dial numbers

Your fax machine has One-Touch keys where you can store fax or phone numbers for automatic dialling. (See *On Hook dialling* on page 7-4.) One-Touch keys are located on the right side of the control panel.

1 Press **Menu/Set**, **6**, **1**.

1 . ONE-TOUCH DIAL

2 Press the One-Touch key where you want to store a number.

3 Enter the number (up to 20 digits).
Press **Menu/Set**.



If you want to enter a pause in the dialling sequence (for example, to access an outside line), press **Redial/Pause** as you're entering digits. Each key press of **Redial/Pause** enters a 3.5-second pause when the number is dialled displayed by a dash on the screen.

4 Use the dial pad to enter the name (up to 15 characters).

NAME :

Press **Menu/Set**. You can use the chart to help you enter letters. (See *Entering text* on page 4-3.)

—OR—

Press **Menu/Set**, to store the number without a name.

5 Press **▲** or **▼** to select the type of number and press **Menu/Set**.

FAX a fax only number

TEL a telephone (voice) number

FAX/TEL both a fax and telephone (voice) number

6 Return to Step 2 to store another One-Touch number.

—OR—

Press **Stop/Exit** to exit.

Storing Speed-Dial numbers

You can store Speed-Dial numbers, so that when you dial you will only have to press a few keys (**Search/Mute**, **#**, the two-digit number, and **Fax Start**). The fax machine can store 100 Speed-Dial numbers.

- 1** Press **Menu/Set**, **6**, **2**.

2 . SPEED-DIAL

- 2** Use the dial pad to enter a two-digit Speed-Dial number (00-99).

#05 :

(For example, press **0 5**.)

Press **Menu/Set**.

ENTER & SET

- 3** Enter the phone or fax number (up to 20 digits).

Press **Menu/Set**.

- 4** Use the dial pad to enter the name (up to 15 characters).

NAME :

Press **Menu/Set**.

(You can use the chart on page 4-3 to help you enter letters.)

—OR—

Press **Menu/Set** to store the number without a name.

- 5** Press **▲** or **▼** to select the type of number and press **Menu/Set**.

FAX a fax only number

TEL a telephone (voice) number

FAX/TEL both a fax and telephone (voice) number

- 6** Go to Step 2 to store another Speed-Dial number.

—OR—

Press **Stop/Exit**.

Changing One-Touch and Speed-Dial numbers

If you try to store a One-Touch or Speed-Dial number where a number has already been stored, the LCD will show the name stored there (or number) and will ask you to do one of the following:

- 1** Press **1** to change the stored number.

1234567

—OR—

Press **2** to exit without making a change.

1 . CHANGE 2 . EXIT

How to change the stored number or name:

- If you want to change a character, use **◀** or **▶** to position the cursor under the character you want to change, and then type over it.
- If you want to erase the whole number or whole name, press **Stop/Exit** when the cursor is under the first digit or letter. The characters above and to the right of the cursor will be deleted.

- 2 Enter a new number.
Press **Menu/Set**.
- 3 Follow the directions beginning at Step 4 in Storing One-Touch Number or Storing Speed-Dial numbers.

Setting up Groups for Broadcasting

Groups, which can be stored on a One-Touch key location, allow you to send the same fax message to many fax numbers by pressing only a One-Touch key and **Fax Start**.

First, you will need to store each fax number as a One-Touch or Speed-Dial number. Then, you can combine them into a Group, *Each Group uses up a One-Touch key*. Finally, you can have up to four small Groups, or you can assign up to 103 numbers to one large Group.

(See *Storing One-Touch Dial numbers* on page 7-1 and *Storing Speed-Dial numbers* on page 7-2.)

- 1 Press **Menu/Set**, **6**, **3**. 3.SETUP GROUPS
- 2 Select a One-Touch key where you wish to store the number. (For example, press One-Touch key **2** to store a Group.)
- 3 Use the dial pad to enter the Group number (1 to 4) and press **Menu/Set**. SETUP GROUP:G0
ENTER & SET
(For example, press **1** for Group 1.)

To include One-Touch or Speed-Dial numbers in the Group, enter them as follows. For example, for One-Touch key 3, press One-Touch key **3**. For Speed-Dial location 09, press **Search/Mute**, then press **0, 9** on the dial pad.

The LCD shows *03, #09.

- 4 Press **Menu/Set** to accept the numbers for this group. G01:*03#09
- 5 Use the dial pad to enter a name for the group and press **Menu/Set**. NAME:
ENTER & SET
(For example, NEW CLIENTS)
(See *Entering text* on page 4-3.)
- 6 Press **Stop/Exit**.



You can print a list of all One-Touch and Speed-Dial numbers. Group numbers will be marked in the GROUP column.
(See *Printing reports* on page 10-1.)

Dialling options

You can use the fax machine to make voice telephone calls by dialling manually or by using Search, One-Touch or Speed-Dial memory. You can use the handset to make calls.

When you dial a quick-dial number, the LCD shows the name you've stored, or if you haven't stored a name, the fax number you've stored.

Manual dialling

Manual dialling is simply pressing all of the digits of the phone number.

- 1 Pick up the handset.
—OR—
Press **Speaker Phone** (FAX-T106 only).
- 2 When you hear a dial tone, dial the call using the dial pad.
- 3 To hang up, replace the handset.
—OR—
Press **Speaker Phone** (FAX-T106 only).

On Hook dialling

- 1 Dial the number by using the dial pad or Quick-Dial keys.
The number you are dialling, or the name you have stored for One-Touch or Speed-Dial is displayed on the LCD.
- 2 For FAX-T104, press **Fax Start** and pick up the handset when you hear the call answered on the monitor speaker. (If you press **Tel** before lifting the handset, the call will be disconnected. Replace the handset to finish the call.)
For FAX-T106, press **Fax Start**, and when the call is answered, you can now speak to the party at the other end without lifting the handset. Press **Speaker Phone** when you finish the conversation.

One-Touch dialling

- 1 Pick up the handset.
—OR—
Press **Speaker Phone** (FAX-T106 only).
- 2 When you hear a dial tone, press the One-Touch key of the location you want to call.
- 3 To hang up a voice call, replace the handset.
—OR—
Press **Speaker Phone** (FAX-T106 only).



If you try to use a One-Touch location with no number stored in it, you will hear a warning sound, and LCD will show **NOT REGISTERED**. The LCD returns to normal after two seconds.

If you are sending a fax, press **Fax Start** after pressing the One-Touch key. If you picked up the handset or pressed **Speaker Phone** (FAX-T106 only), press **Fax Start** when the receiving fax machine answers with fax tones.

Speed-Dialling

- 1 Pick up the handset.
—OR—
Press **Speaker Phone** (FAX-T106 only).
- 2 When you hear a dial tone, press **Search/Mute**, press #, and then press the two-digit Speed-Dial number.
- 3 To hang up a voice call, replace the handset.
—OR—
Press **Speaker Phone**.



If you are sending a fax, press **Fax Start** after entering the Speed-Dial number. If you picked up the handset or pressed **Speaker Phone** (FAX-T106 only), press **Fax Start** when the receiving fax machine answers with fax tones.

Search

You can search for names you have stored in One-Touch and Speed-Dial memories. (See *Storing One-Touch Dial numbers* on page 7-1 and *Storing Speed-Dial numbers* on page 7-2.)

- 1 Pick up the handset.
—OR—
Press **Speaker Phone** (FAX-T106 only).
- 2 Press **Search/Mute**, then enter the first letter of the name you are looking for by using the dial pad.
- 3 Press ◀ or ▶ to search the names that are displayed alphabetically.
- 4 When the screen displays the name you want to call, press **Fax Start** to begin dialling.
- 5 To hang up, replace the handset.
—OR—
Press **Speaker Phone** (FAX-T106 only).

Pause

Press **Redial/Pause** to insert a 3.5-second pause between numbers. If you are dialling overseas, you can press **Redial/Pause** as many times as needed to increase the length of the pause.

Mute

- 1 Press **Search/Mute** to put a call on hold.
- 2 You can replace the handset without disconnecting the call.
- 3 Pick up the fax machine's handset or press **Speaker Phone** (FAX-T106 only) to release the call from hold.

If you press **Search/Mute** without lifting the handset or pressing **Speaker Phone** (FAX-T106 only), this key works as the Search key.



For FAX-T106, you can select to play or not to play a music during a call put on hold. (See *Setting the Music on Hold* on page 4-6.)

Answering Calls with the Speaker Phone (FAX-T106 only)

When the machine rings, instead of lifting the handset, press **Speaker Phone**. Speak clearly, toward the microphone. To end the call, press **Speaker Phone**.

If you have a bad telephone line connection, the other party might hear your voice echoed during the call. Hang up and try the call again—OR—Pick up the handset.

Redial (Telephone)

If you are calling someone and the line is busy, you can retry the number by pressing **Redial/Pause**.

- 1 Pick up the handset.
—OR—
Press **Speaker Phone** (FAX-T106 only).
- 2 Press **Redial/Pause**.
- 3 To hang up, replace the handset.
—OR—
Press **Speaker Phone** (FAX-T106 only).

Redial (Fax)

If you're sending a fax manually and the line is busy, press **Redial/Pause** to try again. Any time you want to make a second call to the last number dialed, press **Redial/Pause** to save time. If you're sending a fax automatically and the line is busy, the fax machine will automatically redial three times at five minutes intervals after the transmission.

Tone or Pulse

If you have a Pulse dialling service, but need to send Tone signals (for example, for telephone banking), follow the instructions below. If you have Touch Tone service, you will not need this feature to send tone signals.

- 1 Pick up the handset.
- 2 Press #. Any digits dialed after this will send tone signals.
- 3 When you hang up, the fax machine will return to the Pulse dialling service.

8

Remote Fax Options (FAX-T104 only)

This chapter is for Model FAX-T104. If you have model FAX-T106, your remote fax options are handled by the Message Manager

Fax Forwarding

Setting up Fax Forwarding

When you select Fax Forward, your fax machine stores the received fax in the memory. The fax machine will then dial the fax number you've programmed and forwards the fax message.

1 Press **Menu/Set**, **8**, **1**.

1. FORWARD/STORE

2 Press **▲** or **▼** to select
FAX FORWARD.

Press **Menu/Set**.

3 Enter the forwarding number (up to 20 digits).

Press **Menu/Set**.

4 Press **▲** or **▼** to select
BACKUP PRINT:ON or
BACKUP PRINT:OFF.

BACKUP PRINT:ON

Press **Menu/Set**.



■ If you select **BACKUP PRINT:ON**, faxes will also be printed at your fax machine so you will have a copy if there is a power failure before it is forwarded.

■ If you select **BACKUP PRINT:OFF**, the data in the memory might be lost when there is a power failure.

The LCD will ask you to enter the fax number to which faxes will be forwarded.

5 Press **Stop/Exit**.

Setting Fax Storage

If you select Fax Storage, your fax machine stores the received fax in the memory. You will be able to retrieve fax messages from another location using the Remote Retrieval commands.

1 Press **Menu/Set, 8, 1.**

1.FORWARD/STORE

2 Press **▲** or **▼** to select
FAX STORAGE.

Press **Menu/Set.**

3 Press **Stop/Exit.**



If you have set Fax Storage, a backup copy will automatically be printed at the fax machine.

Turning off Remote Fax Options

If you set the FORWARD/STORE to OFF and there are faxes in your fax machine's memory, the LCD will give you two options.

- If you press **1**, all unprinted faxes will be printed and erased before the setting turns off. If a backup copy has already been printed it will not be printed again.
- If you press **2**, the memory will not be erased and the setting will be unchanged.

Setting your remote access code

The remote access code lets you access the Remote Retrieval features when you are away from the fax machine. Before you use the remote access and retrieval features, you have to set up your own code. The default code is inactive code (---*).

1 Press **Menu/Set, 8, 2.**

2.REMOTE ACCESS

2 Enter a three-digit code using
numbers 0-9.

Press **Menu/Set.** (The "*" cannot be changed.)



Do not use the same code which is set in your Fax Receive Code (*51) or Telephone Answer Code (#51) or Activation Voice Code (*81). (See *Operation from extension telephones* on page 5-6.)

3 Press **Stop/Exit.**



You can change your code at any time by entering a new one. If you want to make your code inactive, press **Stop/Exit** in Step 2 to restore the inactive setting (---*).

Remote Retrieval

You can call your fax machine from any touch tone telephone or fax machine, then use the Remote Access Code and remote commands to retrieve fax messages. Be sure to cut out the Remote Retrieval Access Card on the last page and keep it with you at all times.

Using your remote access code

- 1** Dial the fax number from a telephone or another fax machine using touch tone.
- 2** When the fax machine answers, immediately enter your Remote Access Code (3 digits followed by *).
- 3** The fax machine signals if it has received fax messages:
1 long beep — Fax messages
No beeps — No fax messages
- 4** The fax machine gives two short beeps, which tells you to enter a command. The fax machine will hang up if you wait longer than 30 seconds to enter a command. The fax machine will beep three times, if you enter an invalid command.
- 5** Press **90** to reset the fax machine when you've finished.
- 6** Hang up.

Remote commands

Follow the commands below to access features when you are away from the fax machine. When you call the fax machine and enter your Remote Access Code (3 digits followed by *), the system will give two short beeps and you must enter a remote command.

| Remote commands | Operation details |
|--------------------------------------|--|
| 95 Change the Fax Forwarding | |
| 1 OFF | You can select OFF after you have registered or erase all the fax messages. |
| 2 Fax Forwarding | If you hear one long beep, the change has been accepted. If you hear three short beeps, you cannot change it because something has not been set up (for example, perhaps a fax forwarding had not been registered). You can register your Fax Forwarding number by entering 4 (see page 8-5). Once you have registered the number, Fax Forwarding will work. |
| 4 Fax Forwarding number | |
| 6 Fax Storage | |
| 96 Retrieve a fax | |
| 1 Print a memory status list | Enter the number of a remote fax machine to print a memory status list. |
| 2 Retrieve all faxes | Enter the number of a remote fax machine to receive stored fax messages. (See page 8-5.) |
| 3 Erase faxes from the memory | If you hear one long beep, you can erase fax messages from the memory. |
| 97 Check the Receiving Status | |
| 1 Document | You can check whether the fax machine has received any faxes. If yes, you will hear one long beep. If no, you will hear three short beeps. |
| 98 Change the Receive Mode | |
| 1 TAD:ANSWER MACH. | If you hear one long beep, your change has been accepted. |
| 2 FAX/TEL | |
| 3 FAX ONLY | |
| 90 Exit | Press 9 0 to exit Remote Retrieval. Wait for the long beep, then replace the handset. |

Retrieving fax messages

- 1 Dial your fax number.
- 2 When your fax machine answers, immediately enter your Remote Access Code (3 digits followed by *). If you hear one long beep, you have messages.
- 3 As soon as you hear two short beeps, use the dial pad to press **9 6 2**.
- 4 Wait for the long beep, and then use the dial pad to enter the number of the remote fax machine where you want your fax messages sent to followed by # # (up to 20 digits).



You cannot use * and # as dial numbers. However, press # if you want to store a pause.

- 5 Hang up after you hear your fax machine beep. Your fax machine will call the other machine, which will then print your fax messages.

Changing your Fax Forwarding number

The default setting of your fax forward number that has been previously stored can be changed from another telephone or fax machine using Touch Tone.

- 1 Dial your fax number.
- 2 When your fax machine answers, immediately enter your Remote Access Code (3 digits followed by *). If you hear one long beep, you have messages.
- 3 When you hear two short beeps, use the dial pad to press **9 5 4**.
- 4 Wait for the long beep, and then use the dial pad to enter the new number of the remote fax machine you want your fax messages forwarded to followed by # # (up to 20 digits).



You cannot use * and # as dial numbers. However, press # if you want to store a pause.

- 5 Hang up after you hear the fax machine beep.

9 Message Manager (FAX-T106 only)

This section is for FAX-T106. (If you have FAX-T104, please see chapter 8 for your remote fax options.)

Message Manager Mode

Message Manager Mode allows you to store incoming fax and voice messages in a flexible memory. The memory stores **15** minutes of voice messages, or up to **20** pages of fax messages. The actual number of pages stored in memory varies depending on the content and the resolution used. Memory is shared between fax and voice messages, which are stored on a “first-come, first-served” basis. Any voice or fax message can be retrieved remotely.

You must record an outgoing message in order to use the Message Manager Mode. (See *Recording the Message Manager’s Outgoing Message (TAD MESSAGE)* on page 9-3.)

Setting Up Message Manager

You must set up Message Manager in the following order:

- 1 Select voice store (and Fax Forward/Fax Storage if necessary.).
- 2 Record the Message Manager’s Outgoing Message (TAD MESSAGE).
- 3 Activate Message Manager (TAD) Mode by pressing .

 If you set both voice and Fax Forward/Fax Storage to OFF, Message Manager does not become activated.

Setting up voice store

When you select voice store, your voice messages are stored in memory.

| | |
|------------|--|
| VOICE: ON | Voice messages are stored in the memory. You can retrieve voice messages remotely. |
| VOICE: EXT | You need an external answering machine connected to the fax machine for this setting. (See <i>Connecting an external telephone answering device (TAD)</i> on page 1-9.) Voice messages are stored in your external answering machine. Retrieve voice messages from the external answering machine. |
| VOICE: OFF | Voice calls are not stored in memory. |

- 1 Press **Menu/Set, 8, 1.**
The screen prompts you to choose a voice store setting.
- 2 Press **▲** or **▼** to select **VOICE: ON**, (or **EXT** or **OFF**). If you want to store voice messages in the external answering machine, select **EXT**.
Press **Menu/Set**.
- 3 Press **Stop/Exit**.

Setting Fax Forward/Fax Storage

You can use either Fax Forward or Fax Storage

| | |
|-------------|--|
| FAX FORWARD | When you select FAX FORWARD , your fax machine stores the received fax in the Message Manager memory. The fax machine will then dial the fax number you've programmed and forwards the fax message. |
| FAX STORAGE | If you select FAX STORAGE , your fax machine stores the received fax in the memory. You will be able to retrieve fax messages from another location using the Remote Retrieval commands. (See <i>Remote Retrieval</i> on page 9-8.) |
| OFF | Incoming faxes are not stored in memory, but will be printed on paper. |

Setting up Fax Forwarding

- 1 Press **Menu/Set, 8, 2.** 2 . FORWARD / STORE
- 2 Press **▲** or **▼** to select **FAX FORWARD**.
Press **Menu/Set**.
The LCD will ask you to enter the fax number to which faxes will be forwarded.
- 3 Enter the forwarding number (up to 20 digits).
Press **Menu/Set**.
- 4 Press **Stop/Exit**.

You can change a Fax Forwarding number remotely. (See *Remote Retrieval* on page 8-3.)

Setting up Fax Storage

- 1 Press **Menu/Set, 8, 2.** 2 . FORWARD / STORE
- 2 Press **▲** or **▼** to select **FAX STORAGE**.
Press **Menu/Set**.
- 3 Press **Stop/Exit**.

Recording the Message Manager's Outgoing Message (TAD MESSAGE)

Recording the Message Manager's Outgoing Message (TAD MESSAGE) is the second step you need to follow before you can turn on the Message Manager. Make sure your OGM (Outgoing Message) is less than 20 seconds long.

- 1 Press **Menu/Set**, **8**, **4**.
The LCD prompts you to choose an OGM.
- 2 Press **▲** or **▼** to select **TAD MESSAGE** (not **F/T MESSAGE**).
Press **Menu/Set**.



This is the only setting you can select if you want to turn the Message Manager on.

- 3 Press **▲** or **▼** to select **RECORD MSG.**
Press **Menu/Set**.
- 4 Pick up the handset to record a message.
For example: Hello. We are unable to take your call at this time. Please leave a message after the signal. If you wish to send a fax, please press *** 5 1**, wait for fax tones, then press the start button.
- 5 Press **Stop/Exit** and replace the handset. The Message Manager plays your OGM.
- 6 Press **Stop/Exit**.

Listening to the Outgoing Message (OGM)

- 1 Press **Menu/Set**, **8**, **4**.
- 2 Press **▲** or **▼** to select **TAD MESSAGE** (or **F/T MESSAGE**).
Press **Menu/Set**.
- 3 Press **▲** or **▼** to select **PLAY MSG** and press **Menu/Set**.
Adjust volume by pressing **◀** or **▶**.
- 4 Press **Stop/Exit**.

Erasing the Outgoing Message (OGM)

- 1 Press **Menu/Set**, **8**, **4**.
- 2 Press **▲** or **▼** to select **TAD MESSAGE** (or **F/T MESSAGE**).
Press **Menu/Set**.
- 3 Press **▲** or **▼** to select **ERASE MSG.**
Press **Menu/Set**.
- 4 Press **1** to erase the OGM.
—OR—
Press **2** to exit without erasing.
- 5 Press **Stop/Exit**.

Activating Message Manager Mode

Press and hold  until the button lights and the screen displays TAD:MSG MGR.

When  light is out, the Message Manager is off. (See *Setting Up Message Manager* on page 9-1.)

Message Indicator

The  light flashes when you have new voice messages and/or faxes waiting for your review.

The LCD shows the total number of voice (including recorded conversations) and/or fax messages stored in Message Manager memory.

VOICE:03 DOC:02

If you press the flashing  to turn off the Message Manager before getting your new messages, they won't be lost. The new messages will be played automatically and the LCD will ask you to acknowledge the new faxes:

PRINT DOC?
1.YES 2.NO

Press **1** to print (and automatically delete) the faxes from memory.
—OR—

Press **2** to save the faxes in memory until printing is convenient.

What Happens When the Memory Is Full?



If the memory becomes full when you have set your fax machine to Message Manager mode, the fax machine will change to F/T mode automatically. In this mode, the fax machine can accept incoming faxes automatically. Then, if your fax machine should run out of paper, the answer mode will shift automatically to manual mode. In manual mode the call is not answered, so your caller will know to try again later.

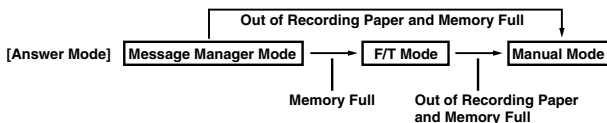

Print the Memory Status List and select the item to be cleared. This will clear space for new messages and faxes to be stored in memory. (See *Printing reports* on page 10-2.)

Playing Voice Messages

Follow the steps below to listen to voice messages.

1 Press **Play/Record**.

Adjust volume by pressing ◀ or ▶.

All new messages are played in the order they were recorded. The LCD shows the number of the current message, and the total number of messages.

If Caller ID information was received, the fax machine beeps during the message and displays the Caller ID information for one second.

During playback, the LCD shows the time and date the message was recorded.

- 2** Press ◀◀ (RWD) at the end of the message to repeat a message. Press ▶▶ (FWD) to skip to the next message. You can press ◀◀ and ▶▶ repeatedly until you reach the message you want to play.

3 Press **Stop/Exit**.

Printing a Fax Message

Once you print a new fax message stored in memory, it is erased from the memory automatically.

- 1** Press **Play/Record**. After two seconds, the fax machine begins to play voice messages.

- 2** After playing voice messages, the display asks if you want to print fax messages that are in the memory. There is no display if there are no faxes.

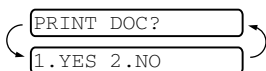

- 3** To print the fax messages, press **1**.

—OR—

Press **2** to exit without printing.

Backup Printing Option

When you have set Fax Forward/Fax Storage to ON in the Message Manager mode, all incoming fax messages are stored in the available memory for retrieval. To print a backup copy automatically, turn this option on.

- 1** Press **Menu/Set**, **8**, **3**. The screen prompts you to select a setting.
- 2** Press ▲ or ▼ to display ON (or OFF).
Press **Menu/Set**.
- 3** Press **Stop/Exit**.

Erasing Messages

If you choose to erase all fax messages, the fax machine will print any previously unprinted fax messages before erasing them from memory. Fax messages cannot be erased individually.

You can erase voice messages individually, or all at once.

To erase voice messages individually

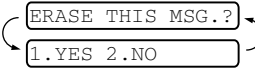
- 1 Press **Play/Record**. The fax machine beeps and begins message playback. Each message is preceded by one long beep, and followed by two short beeps.
- 2 To erase a specific message, press **Erase** immediately after the two short beeps, or while the message is playing. 
- 3 Press **1** to erase the message.
—OR—
Press **2** to cancel.
- 4 Press **Stop/Exit**.

To erase messages all at once

- 1 Press **Erase**.
- 2 Press **▲** or **▼** to select erasing all voice messages, all document messages, or all messages—both voice and fax.
Press **Menu/Set**.
- 3 Press **1** to erase.
—OR—
Press **2** to cancel.
- 4 Press **Stop/Exit**.

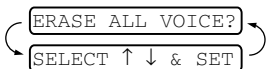

Setting the maximum time for incoming messages

The default time for receiving voice messages is up to 30 seconds long. You can change this setting to any length from 20 seconds to 60 seconds in 5-second increments.

- 1 Press **Menu/Set, 8, 5**.
- 2 Press **▲** or **▼** to select the maximum time setting for incoming messages.
Press **Menu/Set**.
- 3 Press **Stop/Exit**.

Setting the Toll Saver

When you set the Toll Saver feature, the fax machine answers after 5 rings if you don't have messages, and after 3 rings if you do have messages. This way, when you call the fax machine, if it rings 4 times, you know you have no messages, and can hang up, avoiding any toll/call charge.



When Toll Saver is **ON**, it overrides your Ring Delay setting. Toll Saver must be off for the fax machine to operate using your Ring Delay setting. (See *Setting the Ring Delay* on page 5-2.)

- 1 Press **Menu/Set**, **2**, **1**.
- 2 Press **▲** or **▼** to select **TOLL SAVER**.
Press **Menu/Set**.
- 3 Press **▲** or **▼** to select **ON** (or **OFF**).
Press **Menu/Set**.
- 4 Press **Stop/Exit**.

ICM Recording Monitor

This feature lets you turn the speaker volume for voice messages **ON** or **OFF**. When you turn the monitor **OFF**, you will not hear messages as they come in.

- 1 Press **Menu/Set**, **8**, **6**.
- 2 Press **▲** or **▼** to select **OFF** (or **ON**).
Press **Menu/Set**.
- 3 Press **Stop/Exit**.

Recording a Conversation

You can record a telephone conversation by pressing **Play/Record** during the conversation. Your recording can be as long as the Incoming Message Maximum Time. The other party will hear a beep every 15 seconds while recording. To stop recording, press **Stop/Exit**. You cannot record a conversation using the Speakerphone.

Remote Retrieval

You can call your fax machine from any touch tone telephone or fax machine, then use a Remote Access Code and remote commands to retrieve voice (and fax) messages. You can also program and change some settings for your Message Manager.

Using the Remote Access Code

- 1 Dial your fax number from a touch tone telephone or another fax machine using touch tone.
- 2 When your fax machine answers, immediately enter your Remote Access Code. (3 digits followed by *****)
- 3 The fax machine signals if it has received messages.
 - 1 long beep—Fax message(s)**
 - 2 long beeps—Voice message(s)**
 - 3 long beeps—Fax and Voice message(s)**
 - No beeps—no messages**
- 4 The fax machine gives two short beeps to tell you to enter a command. The fax machine hangs up if you wait longer than 30 seconds to enter a command. The fax machine beeps three times if you enter an invalid command.
- 5 Press **9 0** to reset the fax machine when you've finished.
- 6 Hang up.

Setting your Remote Access Code

The remote access code lets you access the Remote Retrieval features when you are away from your fax machine. Before you use the remote access and retrieval features, you have to set up your own code. The default code is inactive code (**---***).

- 1 Press **Menu/Set, 8, 7**.
- 2 Enter a three-digit code using number keys 0-9, ***** and **#**. Press **Menu/Set**.
(The preset ***** cannot be changed.)

 Do not use the same code which is set in your Fax Receive Code (***51**), Telephone Answer Code (**#51**) or DECT Activation Voice Code (***81**).

- 3 Press **Stop/Exit**.

 You can change your code at any time by entering a new one. If you want to make your code inactive, press **Stop/Exit** in Step 2 to restore the inactive setting (**---***).

Remote commands

Follow the commands below to access features when you are away from the fax machine. When you call the fax machine and enter your Remote Access Code (3 digits followed by *), the system will give two short beeps and you must enter a remote control command.

| Remote commands | Operation details |
|---|--|
| 91 Playing voice messages | After one long beep, the fax machine plays ICM. |
| 1 Repeat or Skip Backward | Press 1 while listening to an ICM to repeat. If you press 1 before a message, you will hear the previous message. |
| 2 Skip Forward | While playing ICM, you can skip to the next message. |
| 9 STOP Playing | Stop playing the ICM. |
| 93 Erase all ICM | If you hear one long beep, the erase is accepted. If you hear three short beeps, you cannot erase because all voice messages have not been played, or there is no voice message to erase. *This code erases all recorded messages, not one at a time. |
| 94 Play and Record OGM in memory | |
| 1 Play | 1 TAD message 2 F/T message |
| 2 Record | 1 TAD message 2 F/T message |
| 95 Changing Fax Forwarding setting | If you hear one long beep, the change has been accepted. If you hear three short beeps, you cannot change it because the conditions have not been met (Example: registering Fax Forwarding number). You can register your Fax Forwarding number by using 4. (See <i>Changing the Fax Forwarding Number</i> on page 9-11.) Once you have registered the number, Fax Forwarding will work. Then retrieve a Memory Status List by entering 96 1 to make sure that the Fax Forwarding number you registered is correct in the List. |
| 1 OFF | |
| 2 Fax Forwarding | |
| 4 Fax Forwarding number | |
| 6 Fax Storage | |
| 96 Retrieve Fax | Enter the number of a remote fax machine to receive the Memory Status List or stored fax messages. (See <i>Retrieving the Memory Status List</i> on page 9-10 and <i>Retrieving Fax Messages</i> on page 9-10.) |
| 1 Memory Status List | |
| 2 Retrieve all faxes | |
| 97 Check the receiving status | You can check whether your fax machine has received any Document or Voice messages. If yes, you will hear one long beep. If no, you will hear three short beeps. |
| 1 Document | |
| 2 Voice | |

| Remote commands | Operation details |
|---|--|
| 98 Change Receive Mode 1TAD 2FAX/TEL 3FAX | If you hear one long beep, you can change the receive mode. If you hear three short beeps, you cannot change it. (Example: There is no TAD message when you want to change to TAD mode.) |
| 90 Exit | After a long beep, you can exit Remote Retrieval. |

Retrieving the Memory Status List

You can retrieve the Memory Status List from a remote fax machine to see if you have any fax messages.

- 1 Dial your fax number.
 - 2 When your fax machine answers, immediately enter your Remote Access Code (3 digits followed by *).
 - 3 When you hear two short beeps, use the dial pad to press **9 6 1**.
 - 4 Using the dial pad, enter the number (up to 20 digits) of the remote fax machine where you want the Memory Status List forwarded, and then press # #.
-  You cannot use * and # as dial numbers. However, if you want to store a pause, press #.
- 5 After you hear your fax machine beep, hang up and wait. Your fax machine calls the remote fax machine and sends the Memory Status List. The remote fax machine prints the List.

Retrieving Fax Messages

- 1 Dial your fax number.
 - 2 When your fax machine answers, immediately enter your Remote Access Code (3 digits followed by *). If you hear one long beep, you have messages.
 - 3 As soon as you hear two short beeps, use the dial pad to press **9 6 2**.
 - 4 Wait for the long beep, and then use the dial pad to enter the number of the remote fax machine where you want your fax messages sent to followed by # # (up to 20 digits).
-  You cannot use * and # as dial numbers. However, press #, if you want to store a pause.
- 5 Hang up after you hear your fax machine beep. Your fax machine will call the other fax machine, which will then print your fax messages.

Changing the Fax Forwarding Number

You can change the default setting of your Fax Forward number from another telephone or fax machine using touch tone.

- 1** Dial your fax number.
- 2** When your fax machine answers, immediately enter your Remote Access Code (3 digits followed by *). If you hear one long beep, you have messages.
- 3** When you hear two short beeps, use the dial pad to press **9 5 4**.
- 4** Wait for long beep, and then use the dial pad to enter the new number of the remote fax machine where you want your fax messages followed by # # (up to 20 digits).



You cannot use * and # as dial numbers. However, if you want to store a pause, press #. Also, if your fax machine is connected to a PABX, you can press # first before the fax machine's number. The # works as well as R key.

- 5** To retrieve the Memory Status List, when you hear two short beeps, use the dial pad to press **9 6 1**.
- 6** Use the dial pad to enter the number of the remote fax machine (up to 20 digits), and then press # #.
- 7** After you hear your fax machine beep, hang up and wait. Your fax machine calls the remote fax machine. Your fax machine then sends the Memory Status List showing the new forwarding number to the remote fax machine.
- 8** Check the forwarding number.
If the forwarding number is incorrect, return to Step 1 to reset it.

10 Printing reports

FAX settings and activity

Your fax machine can print a XMIT Report after each fax you send. Also, a journal of sent and received faxes can be printed at specified intervals.

Customizing the Transmission Verification Report

You can use the Transmission Report as proof that you sent a fax. This report lists the time and date of transmission and whether the transmission was successful (OK). If you select **ON**, the report will print for every fax you send.

 When the feature is **OFF**, the Report will only print if there is a transmission error (NG).

- 1 Press **Menu/Set**, **7**, **1**.
- 2 Press **▲** or **▼** to select **ON** or **OFF**.
Press **Menu/Set**.
- 3 Press **Stop/Exit**.

1.XMIT REPORT

Setting the Journal Period

You can set the fax machine to print a journal at specific intervals (every 30 faxes, 6, 12 or 24 hours, 2 or 7 days). If you set the journal period to **OFF**, you can print the report by following the steps on the next page.

The default setting is **EVERY 30 FAXES**.

- 1 Press **Menu/Set**, **7**, **2**.
- 2 Press **▲** or **▼** to choose a journal period.
- 3 Press **Menu/Set**.
(If you choose 7 days, the LCD will ask you to choose a day on which to begin the 7-day countdown.)
- 4 Enter the time to begin printing in 24-hour format.
Press **Menu/Set**.
(For example: enter 19:45 for 7:45 P.M.)
- 5 Press **Stop/Exit**.

2.JOURNAL PERIOD

 If you select 6, 12, 24 hours, 2 or 7 days, the fax machine will print the report at the selected time and then erase all jobs from its memory. If the fax machine's memory becomes full with 30 jobs before the time you selected has passed, the fax machine will print the Journal early and then erase all jobs from memory. If you want an extra report before it is due to print, you can print it without erasing the jobs from memory.

Printing reports

Following reports are available:

1. XMIT VERIFY

Prints a Transmission Verification Report for the last fax that was sent.

This information will remain until you pick up the handset or press

Speaker Phone (FAX-T106 only).

2. HELP LIST

Prints the Help List so you can see at-a-glance how to quickly program your fax machine.

3. QUICK-DIAL

Lists names and numbers stored in One-Touch and Speed-Dial memory, in numerical order.

4. FAX JOURNAL

Lists information about the last incoming and outgoing faxes. (TX means Transmit.) (RX means Receive.)

5. TEL. INDEX

Quick-Dial list (above), alphabetically.

6. USER SETTINGS

Lists your settings.

7. MEMORY STATUS

Lists summary information and amount of occupied memory.

How to print a report

- 1 Make sure that there is no document in the ADF.
- 2 Press **Copy/Reports**, then enter the number (see list above) of the report you want to print. For example, press **6** to print the **USER SETTINGS**.

11 Making copies

Using the fax machine as a copier

You can use this fax machine as a copier. Always make sure you have paper in the paper tray before making copies.

Copy Key



Incoming faxes cannot be received on paper or into the memory while the fax machine is copying.

Copy operations

To make a single copy that is not reduced, enlarged or sorted, you only have to press one key. Remember, your fax machine cannot scan anything closer than 4 mm from the edge of the paper.

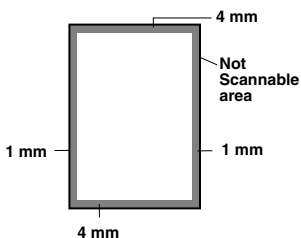

Making a single copy

- 1 Insert the document face down in the ADF.
- 2 Press **Copy/Reports** twice.
To cancel, press **Stop/Exit**.
Do NOT pull on the paper while copying is in progress.



The default resolution for a single copy is **S.FINE**. Set the resolution to **PHOTO** for photographs by using the **Resolution** key.

Copy options: Single or Multiple copies, Sort/Stack, Reduce/Enlarge

You can choose additional copy options. First, you can select the number of copies. Next, you can choose whether multiple copies will be STACKED (all copies of page 1, then all copies of page 2, etc.) or SORTED (collated). Finally, you can choose an enlargement or reduction ratio. To automatically reduce the copy to the paper size you have set for the paper tray, select **AUTO**. To reduce the copy by a fixed percentage, choose 93%, 87%, 75% or 50%. Or, to enlarge the copy, select 150%, 125% or 120%. To copy a document at its document size, select 100%.

1 Insert the document face down in the ADF.

2 Press **Copy/Reports**.

3 Enter the number of copies you want (1-99).

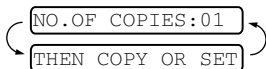

To start copying now, press **Copy/Reports**.

If you would like to select additional copy options, like **SORT**, **ELG/RDC** (Enlarge or Reduce) press **Menu/Set**.

4 Press **▲** or **▼** to select **SORT** or **STACK**.

To start copying now without enlarging or reducing, press **Copy/Reports**.

To reduce or enlarge the image, press **Menu/Set**.

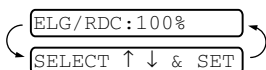

5 Press **▲** or **▼** to select an enlargement or reduction ratio.

6 Press **Copy/Reports**.

 If you are making multiple copies and get a **OUT OF MEMORY** message while you are scanning the first page, press **Stop/Exit** to cancel the job. Then make a single copy. If you selected **SORT** and the **OUT OF MEMORY** message appears while scanning subsequent pages, you can press **Copy/Reports** to copy the portion that is in memory, or press **Stop/Exit** to cancel. To restart the copy job using less memory, press **Copy/Reports** for stacked copies.

 The default resolution for multiple copies or reducing and enlarging copies is **FINE**. Set the resolution to **S.FINE** for small print or artwork and **PHOTO** for photographs by using the **Resolution** key. **S.FINE** and **PHOTO** resolutions use up more memory than **FINE** mode.

12 Important information

Important safety instructions

- 1 Read all of these instructions.
- 2 Save them for later reference.
- 3 Follow all warnings and instructions marked on the product.
- 4 Unplug this product from the wall socket before cleaning. Do not use liquid or aerosol cleaners. Use a damp cloth for cleaning.
- 5 Do not use this product near water.
- 6 Do not place this product on an unstable cart, stand, or table. The product may fall, causing serious damage to the product.
- 7 Slots and openings in the cabinet and the back or bottom are provided for ventilation; to ensure reliable operation of the product and to protect it from overheating, these openings must not be blocked or covered. The openings should never be blocked by placing the product on a bed, sofa, rug, or other similar surface. This product should never be placed near or over a radiator or heater. This product should never be placed in a built-in installation unless proper ventilation is provided.
- 8 This product should be operated from the type of power source indicated on the label. If you are not sure of the type of power available, call your dealer or local power company.
- 9 This product is equipped with a 3-wire grounded type plug, a plug having a third (grounded) pin. This plug will only fit into a grounded-type electrical socket. This is a safety feature. If you are unable to insert the plug into the outlet, call your electrician to replace your obsolete outlet. Do not defeat the purpose of the grounded-type plug.
- 10 Do not allow anything to rest on the power cord. Do not place this product where people can walk on the cord.
- 11 Do not place anything in front of the fax machine that will block received faxes. Do not place anything in the path of received faxes.
- 12 Wait until pages have exited the fax machine before picking them up.
- 13 Never push objects of any kind into this product through cabinet slots, since they may touch dangerous voltage points or short out parts resulting in the risk of fire or electric shock. Never spill liquid of any kind on the product.
- 14 Do not attempt to service this product yourself, as opening or removing covers may expose you to dangerous voltage points and/or other risks, and may void your warranty. Refer all servicing to service personal.

- 15** Unplug this product from the power socket and refer servicing to Authorized Service Personnel under the following conditions:
- When the power cord is damaged or frayed.
 - If liquid has been spilled into the product.
 - If the product has been exposed to rain or water.
 - If the product does not operate normally when the operating instructions are followed. Adjust only those controls that are covered by the operating instructions. Improper adjustment of other controls may result in damage and will often require extensive work by a qualified technician to restore the product to normal operation.
 - If the product has been dropped or the cabinet has been damaged.
 - If the product exhibits a distinct change in performance, indicating a need for service.
- 16** To protect your product against power surges, we recommend the use of a power protection device (Surge Protector).

Trademarks

The Brother logo is a registered trademark of Brother Industries, Ltd.

Brother is a registered trademark of Brother Industries, Ltd.

© 2004 Brother Industries, Ltd. All rights reserved.

All other brand and product names mentioned in this manual are registered trademarks of their respective companies.

Shipment of the fax machine

If for any reason you must ship your fax machine, carefully package the fax machine to avoid any damage during transit. We recommend that you save and use the original packaging. The fax machine should also be adequately insured with the carrier.

13 Troubleshooting and routine maintenance

Troubleshooting

IMPORTANT

For technical help, you must call the country where you bought the fax machine. Calls must be made **from within** that country.

Error messages

As with any sophisticated office product, errors may occur. If this happens, your fax machine identifies the problem and displays an error message. The most common error messages are shown below.

| ERROR MESSAGES | | |
|---|--|---|
| ERROR MESSAGE | CAUSE | ACTION |
| BT CALL SIGN ON | The fax machine is set BT Call Sign to ON. You cannot change the Receive Mode from Manual to another mode. | Set BT Call Sign to OFF. (See <i>BT Call Sign (U.K. only)</i> on page 5-14.) |
| CHECK PAPER RELOAD PAPER PRESS STOP KEY | The fax machine is out of paper or paper is not properly loaded in the paper tray. | Refill the paper or remove the paper and load it again. If this error appears while receiving a fax, load paper to restart printing. If you were copying or printing reports, load paper and try again. (See <i>How to load paper</i> on page 2-2.) |
| | The paper is jammed in the fax machine. | See <i>Paper Jam</i> on page 13-5. |
| COVER IS OPEN CLOSE COVER | The cover is not closed completely. | Close the cover. |
| DOCUMENT JAM REMOVE JAM PRESS STOP KEY | The documents were not inserted or fed properly, or were too long. (See <i>Document Jam</i> on page 13-4.) | Insert the document again. |
| | The document is jammed in the fax machine. | See <i>Document Jam</i> on page 13-4. |
| LINE DISCONNECT | The other person or other person's fax machine stopped the call. | Try to send again. |
| MEMORY NEAR ZERO CLEAR MEMORY | The fax machine is almost out of memory. | Clear the faxes and scheduled jobs from the memory. —OR— Print the faxes that are in the memory. (See <i>Printing a fax from the memory (FAX-T104 only)</i> on page 5-8.) |

| ERROR MESSAGES | | |
|---|---|--|
| ERROR MESSAGE | CAUSE | ACTION |
| NOT REGISTERED | You tried to access a One-Touch or Speed-Dial number that is not programmed. | Set up the One-Touch or Speed-Dial number. (See <i>Storing One-Touch Dial numbers</i> on page 7-1 and <i>Storing Speed-Dial numbers</i> , page 7-2.) |
| OUT OF MEMORY CLEAR MEMORY | The data is too large for the fax machine's memory. | (Fax sending or copy operation in process) Press Stop/Exit and wait until the other operations in progress finish and then try again. —OR— Clear the faxes and schedule jobs in the memory. To gain extra memory, you can turn off Fax Storage. (See <i>Setting Fax Storage</i> on page 8-2.) —OR— Print the faxes that are in the memory. (See <i>Printing a fax from the memory (FAX-T104 only)</i> on page 5-8.) (See <i>Printing a Fax Message</i> on page 9-5.) |
| PAPER JAM PLS OPEN COVER REMOVE JAM | The paper is jammed in the fax machine. | (See <i>Document Jam or Paper Jam</i> on page 13-4.) |
| PHONE LINE BUSY | The number you dialed does not answer or is busy. | Verify the number and try again. |
| POLLING FAILED | You tried to poll a fax machine that is not in Polled Waiting mode. | Check the other fax machine's polling setup. |
| PRINTHEAD OVERHEATED WAIT TO COOL | The print head has overheated. | Wait 30 minutes for it to cool or wait until the message disappears automatically. |
| RECEIVE FAILED | Poor phone line quality caused a communication error. | If the problem continues, call the telephone company and ask them to check your phone line. |
| RIBBON EMPTY RESET OR REPLACE | Your fax machine is out of ribbon or the print cartridge is not properly installed. | Install the print cartridge again or change the ribbon. (See <i>Changing the ribbon</i> on page 13-9.) |

ERROR MESSAGES

| ERROR MESSAGE | CAUSE | ACTION |
|---|--|--|
| <p>MEMORY DISABLED (Fax-T106) TAD FAILURE UNABLE TO INIT UNABLE TO PRINT UNABLE TO SCAN</p> | <p>The fax machine has a mechanical problem. —OR— A foreign obstacle, such as a clip or ripped paper, is in the fax machine.</p> | <p>Open the top cover and remove any foreign obstacles from inside the fax machine. If the error message continues, disconnect the fax machine from the power for several minutes then reconnect it. You will lose all faxes in the memory. Please follow the steps below before disconnecting the fax machine so you will not lose any important messages.</p> <p>Check whether the fax machine has faxes in the memory</p> <ol style="list-style-type: none"> 1. Press Menu/Set, 0, 0, 1. 2. If the fax machine does not have faxes in its memory, disconnect the fax machine from the power source for several minutes and then reconnect it. <p>—OR—</p> <p>If faxes are present, you can transfer them to another fax machine. Go to Step 3.</p> <p>Transfer faxes to another fax machine</p> <ol style="list-style-type: none"> 3. Enter the fax number to which faxes will be forwarded. 4. Press Fax Start. 5. After the faxes are transferred, disconnect the fax machine from the power source for several minutes and then reconnect it. <p>Transfer Journal report to another fax machine</p> <p>You can transfer the Fax Journal report to another fax machine.</p> <ol style="list-style-type: none"> 1. Press Menu/Set, 0, 0, 2. 2. Enter the fax number to which faxes will be forwarded. 3. Press Fax Start. <p>If you have not set up your Station ID, you cannot enter fax transfer mode.</p> <p>If the error message still continues, contact Brother or your dealer for service.</p> |

Compatibility

If you are having difficulty sending or receiving a fax due to possible interference on the phone line, we recommend that you try setting the compatibility to **BASIC**.

- 1 Press **Menu/Set**, **0**, **2**.
- 2 Press **▲** or **▼** to select **BASIC** (or **NORMAL**).

2.COMPATIBILITY

Press **Menu/Set**.

- 3 Press **Stop/Exit**.



FAX-T106 only

- **BASIC** reduces the default modem speed to 9600 bps. Unless interference is a recurring problem on your phone line, you may prefer to use it only when needed.
- **NORMAL** sets the modem speed at 14400 bps.

Document Jam or Paper Jam

Document Jam

The documents were not inserted or fed properly, or were too long.

- 1 Remove any paper that is not jammed from the ADF.
- 2 Open the top cover by lifting the lever on the right side of the top cover.

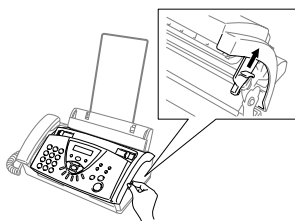

- 3 Pull the document toward the front of your fax machine.

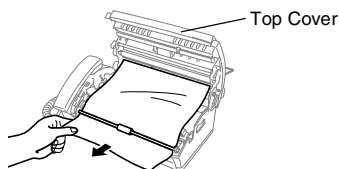

Document is jammed.

- 4 Close the top cover. Press down on both sides of the top cover until it clicks.

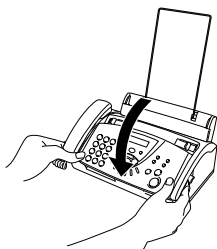

Paper Jam

The paper is jammed in your fax machine.

- 1 Remove any paper that is not jammed.

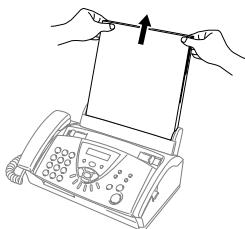

- 2 Open the top cover by lifting the lever on the right side of the top cover.

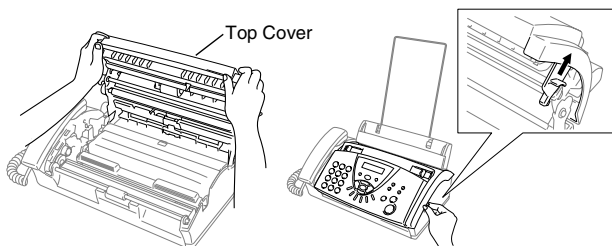

- 3 Pull the jammed paper gently from the paper feeder toward the front of the fax machine as per diagram A.
If you can't, pull the jammed paper towards the back and remove it as per diagram B.

Diagram A

Diagram B

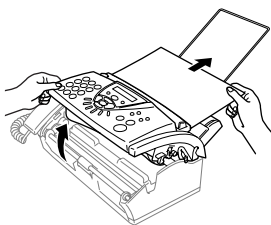
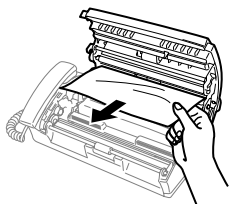

Printout is jammed.

- 4 Close the top cover. Press down on both sides of the top cover until it clicks.

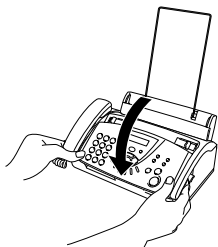

- 5 Put the paper back into the paper tray.

If you are having difficulty with the fax machine

If you think there is a problem with your fax machine or the way your faxes look, *make a copy first*. If the copy looks good, the problem is probably not the fax machine. Check the chart below and follow the troubleshooting tips.

| DIFFICULTY | SUGGESTIONS |
|---|---|
| Printing or Receiving Faxes | |
| Condensed print and white streaks across the page or the top and bottom of sentences are cut off. | If your copy looks good, you probably had a bad connection, with static or interference on the phone line. If the copy looks bad, clean the scanner. (See <i>Cleaning the scanner</i> on page 13-9.) If the problem continues, call Brother or your dealer for service. |
| Vertical black lines when receiving. | Your machine's print head might be dirty. Clean the print head. (See <i>Cleaning the print head</i> on page 13-8.) The sender's scanner may be dirty. Ask the sender to make a copy to see if the problem is with the sending machine. Try receiving from another fax machine. If the problem continues, call Brother or your dealer for service. |
| Phone Line or Connections | |
| The fax machine does not answer when called. | Make sure receive mode is not set to MANUAL . (See <i>Choosing the Receive Mode</i> on page 5-1.) Check for a dial tone. If possible, call the fax machine to hear it answer. If there is still no answer, check the telephone line cord connection. Connect a standard telephone to the fax machine's telephone socket. If there is no ringing when you call the fax machine, ask your telephone company to check the line. |
| External Telephone answering device (TAD) does not answer when called | Make sure that the external TAD is connected correctly. (See <i>Connecting an external telephone answering device (TAD)</i> on page 1-9.) Make sure the TAD is set to answer calls. |
| No dial tone on the handset | Press Speaker Phone (FAX-T106 only)— OR —Lift the handset. If you don't hear a dial tone, check telephone line cord connections at the fax machine and wall socket. Check that the handset is connected to the fax machine's handset socket. Test the wall socket with another single line telephone. If there is no dial tone at the wall socket, call your telephone company. |
| Receiving Faxes | |
| Cannot receive a fax | Make sure that the fax machine is in the correct receiving mode for your setup. (See <i>Choosing the Receive Mode</i> on page 5-1.) |
| | If there seems to be interference on your phone line, try setting the Compatibility to BASIC . (See <i>Compatibility</i> on page 13-4.) |
| | If you connect your fax machine to PABX or ISDN, set the Phone Line Type to your phone type. (See <i>Setting the Phone Line Set</i> on page 4-5.) |
| Sending Faxes | |
| Cannot send a fax | Ask the other party to check that the receiving machine has paper. |
| | Print the Transmission Verification Report and check for an error. (See <i>Printing reports</i> on page 10-1.) |
| Poor sending quality. | Try changing your resolution to FINE or S.FINE . Make a copy to check the fax machine's scanner operation. |

| DIFFICULTY | SUGGESTIONS |
|--|---|
| Dialling does not work | <p>Check all line cord connections. Check the power cord connection. Send a manual fax by pressing Speaker Phone (for FAX T-106 only) or by lifting the handset and dialling the number. Wait to hear fax receiving tones before pressing Fax Start. Change the Tone/Pulse setting. (See <i>Setting Tone or Pulse dialling mode</i> on page 4-5.)</p> |
| Vertical black lines when sending. | <p>Use the fax machine to make a copy. If the copy shows the same problem, the scanner area is dirty. Lift the top cover and check the document path. Clean the white film and the scanner's glass strip using isopropyl alcohol and a lint-free cloth. (See <i>Cleaning the scanner</i> on page 13-9.)</p> |
| Transmission Verification Report prints "RESULT ERROR" | <p>There is probably temporary noise or static on the phone line. Try sending the fax again. Try setting the Compatibility to BASIC. (See <i>Compatibility</i> on page 13-4.) If the problem continues, call the telephone company to check your phone line.</p> |
| Handling Incoming Calls | |
| Double-ring in FAX/TEL mode | <p>The fax machine knows the incoming call is not a fax so it is signaling you to answer the telephone call. Pick up the fax machine's handset or answer from an extension phone, and then press the fax machine's Telephone Answer Code (default setting is #51). (See <i>For FAX/TEL mode only</i> on page 5-6.)</p> |
| Transferring a call to the fax machine | <p>If you have answered at the fax machine's handset, press Fax Start and hang up immediately. If you answered at an extension phone, press your three-digit Fax Receive Code (default setting is *51). When the fax machine answers, hang up.</p> |
| The fax machine "hears" voice as fax tone | <p>If the fax machine is set to Fax Detect ON, it is more sensitive to sounds. The fax machine may mistakenly interpret certain voices or music on the line as a calling fax machine and respond with fax receiving tones. Deactivate the fax by pressing #51 if you are at an extension phone or press Stop/Exit if you are at the fax machine or an external phone. Try avoiding this problem by turning Fax Detect to OFF. (See <i>Recording the Fax/Tel Outgoing Announcement (F/T MESSAGE) (FAX-T106 only)</i> on page 5-3.)</p> |
| Custom features on a single line | <p>If you have Call Waiting, Voice Mail, an alarm system or any other custom feature on a single phone line with the fax machine, it may create a problem sending or receiving fax data. For example: If you are sending or receiving a fax message while a custom feature signal comes through on the line, the signal can temporarily interrupt or disrupt the fax data. Your fax machine's ECM feature should help overcome this problem. This condition is related to the telephone system industry and is common to all devices that send and receive data on a single, shared line with custom features. If avoiding a slight interruption is crucial to your business, we recommend a separate phone line with no custom features.</p> |

Routine maintenance

Cleaning the print head

Clean the print head when you want to improve the print quality and also as part of your routine maintenance.

⚠ After you have just used the fax machine, some internal parts of the fax machine are extremely **HOT!** So please be careful.

- 1 Unplug the telephone line cord and the power cord for safety.
- 2 Open the top cover by lifting the lever on the right side of the top cover.
- 3 Take out the print cartridge.

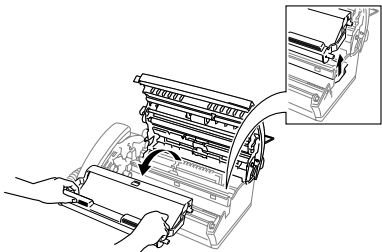

- 4 To clean your fax machine's print head, wipe the print head with a lint-free cloth that is dry or lightly moistened with isopropyl alcohol.

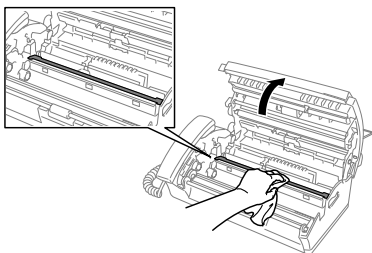

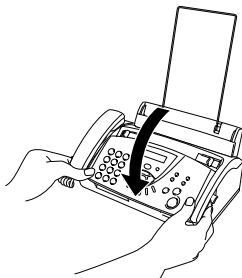

- 5 Wait until the alcohol on the print head is completely dry.
- 6 Install the print cartridge. (See *Changing the ribbon* on page 13-9.)
- 7 Close the top cover. Press down on both sides of the top cover until it clicks.

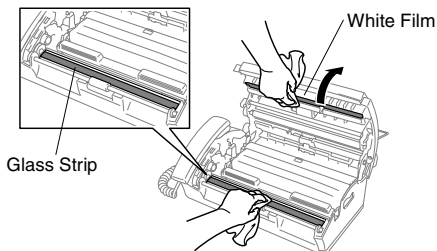

Cleaning the scanner

- 1 Unplug the telephone line cord and the power cord for safety.
- 2 Open the top cover by lifting the lever on the right side of the top cover.
- 3 Clean the white film and the glass strip with isopropyl alcohol on a lint-free cloth.



 Be careful not to bend the white film or drop anything into the fax machine.

- 4 Close the top cover. Press down on both sides of the top cover until you hear it click into place.

Changing the ribbon

The starter ribbon prints up to 30 pages.

- 1 Open the top cover by lifting the lever on the right side of the top cover.

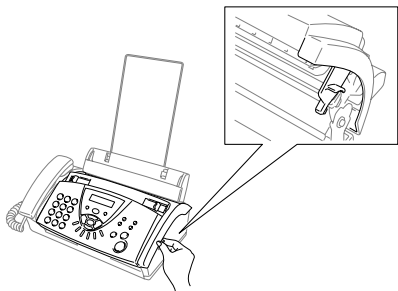

- 2 Remove the print cartridge containing the used ribbon and set it upside-down with the blue gear in the upper left corner.

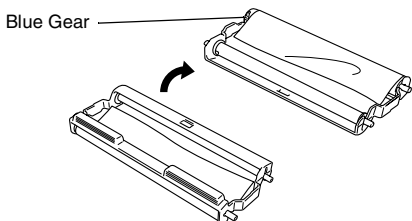

3 Take the used ribbon out of the cartridge:

- ① Snap out the upper and lower right white spools.
- ② Slide the roll off the blue gear and lower left white spool.
(Do not remove the blue gear and lower left white spool).

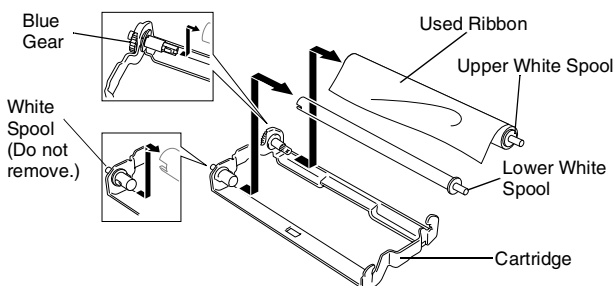

4 Slide the white elastic off the new refill rolls and set them down with the full roll in the lower position. (The ribbon's shiny side is facing *down*.)

5 Remove the white spools from the ends of the used cardboard cores. Then insert them into the same positions in the new cores.

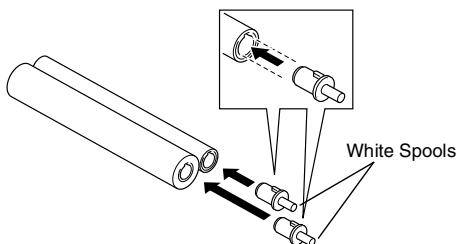

6 Install the new ribbon in the cartridge:

- ① Slip the lower left cardboard core onto white spool of the cartridge and then slip the upper blue core onto the blue gear of the cartridge.
- ② Insert the upper and lower right white spools into the holders.

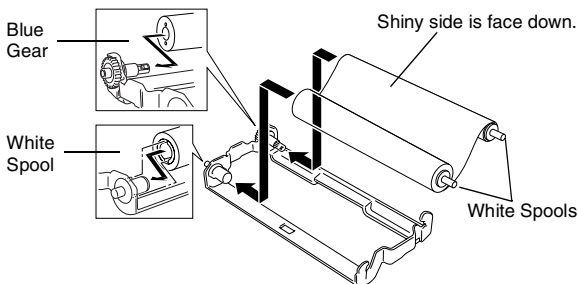

Insert the teeth of the white spool into the cutouts of the cardboard core.

- 7 Turn the upper right white spool *clockwise* to tighten the ribbon, as shown.

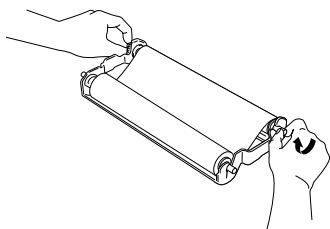

- 8 Turn the cartridge over and re-install it in your fax machine: Insert the recessed  first and place the cartridge into its four holders.

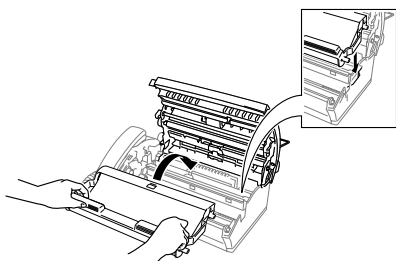
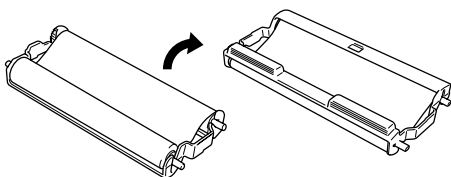

- 9 Press down on both sides of the top cover to close it securely.

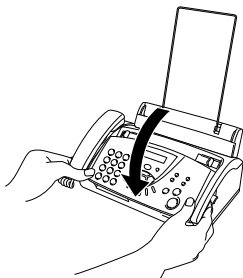

G Glossary

- ADF (automatic document feeder)** The document can be placed in the ADF and scanned one page at a time automatically.
- Automatic fax transmission** Sending a fax without picking up the handset or pressing **Speaker Phone** (FAX-T106 only).
- Automatic Redial** A feature that enables your fax machine to redial the last fax number after five minutes if the fax did not go through because the line was busy.
- Auto Reduction** Reduces size of incoming faxes.
- Backup Print** Sets the fax machine to print a copy of every fax that is received and stored in memory. This is a safety feature so you will not lose message during a power failure.
- Beeper Volume** Volume setting for the beep when you press a key or make an error.
- Broadcasting** The ability to send the same fax message to more than one location.
- Call Reservation** Allows you send a fax and then at the end of transmission, you can talk with the other party.
- Caller ID** A service purchased from the Telephone Company that lets you see the number (or name) of the party calling you.
- Cancel Job** Cancels a programmed job, like Delayed Fax or Polling.
- CNG tones** The special tones (beeps) sent by fax machines during automatic transmission to tell the receiving machine that a fax machine is calling.
- Communication error (or Comm. Error)** An error during fax sending or receiving, usually caused by line noise or static.
- Contrast** Setting to compensate for dark or light documents, by making faxes or copies of dark documents lighter and light documents darker.
- Cover Page** Prints a page at the other party's machine that contains the sender and recipient's name and fax number, number of pages and comment. You can generate an electronic cover page at the other end with pre-programmed information from memory or you can print a sample cover page to fax with your document.
- Delayed Fax** Sends your fax at a specified later time that day.
- ECM (Error Correction Mode)** Detects errors during fax transmission and resends the pages of the fax that had an error.
- Extension telephone** A telephone on the fax number that is plugged into a separate telephone wall socket.
- External telephone** A TAD (telephone answering device) or telephone that is connected to your fax machine.

- F/T Ring Time** The length of time that the Brother fax machine rings (when the receive mode setting is FAX/TEL) to notify you to pick up a voice call that it answered.
- Fax Detect** Enables the fax machine to respond to CNG tones if you interrupt a fax call by answering it.
- Fax Forwarding** Sends a fax received in memory to another pre-programmed fax number.
- Fax Receive Code** Press this code (* 5 1) when you answer a fax call from an extension or external phone.
- Fax Storage** You can store faxes in memory.
- Fax tones** The signals sent by sending and receiving fax machines while communicating information.
- FAX/TEL** You can receive faxes and telephone calls. Do not use this mode if you are using a telephone answering device (TAD).
- Fine resolution** Resolution is 203 x 196 dpi. It is used for small print and graphs.
- Group number** A combination of One-Touch and/or Speed-Dial numbers that are stored on a One-Touch key for Broadcasting.
- Help list** A printout of the complete Menu that you can use to program your fax machine when you do not have the User's Guide with you.
- LCD (liquid crystal display)** The display screen on the fax machine that shows interactive messages during On-Screen Programming and shows the date and time when the fax machine is idle.
- Manual fax** When you lift the handset or press **Speaker Phone** (FAX-T106 only) so you can hear the receiving fax machine answer before you press **Fax Start** to begin transmission.
- Menu mode** Programming mode for changing your fax machine's settings.
- Next Fax Reservation** Accepts the next document in the ADF for transmission while the fax machine is still receiving.
- One-Touch** Keys on the fax machine's control panel where you can store numbers for easy dialling. You must use a separate key for each number.
- Out of Paper Reception** Receives faxes into the fax machine's memory when the fax machine is out of paper.
- Overseas Mode** Makes temporary changes to the fax tones to accommodate noise and static on overseas phone lines.
- Pause** Allows you to place a 3.5 second delay in the dialling sequence stored on One-Touch keys or Speed-Dial numbers.
- Photo resolution** A resolution setting that uses varying shades of gray for the best representation of photographs.
- Polling** The process of a fax machine calling another fax machine to retrieve waiting fax messages.
- Pulse** A form of rotary dialling on a telephone line.
- Quick Dial List** A listing of names and numbers stored in One-Touch and Speed-Dial memory, in numerical order.

- Remote Access Code** Your own four-digit code (---*) that allows you to call and access the fax machine from a remote location.
- Resolution** The number of vertical and horizontal lines per inch. See: Standard, Fine, Super Fine and Photo.
- Ring Delay** The number of rings before the fax machine answers in FAX ONLY, FAX/TEL, and TAD:MSG MGR (FAX-T106 only) mode.
- Search** An electronic, alphabetical listing of stored One-Touch, Speed-Dial and Group numbers.
- Speed-Dial** A pre-programmed number for easy dialling. You must press the **Search/Mute** key and then #, two digit code to start the dialling process.
- Standard resolution** 203 x 98 dpi. It is used for regular size text and quickest transmission.
- Station ID** The stored information that appears on the top of faxed pages. It includes the sender's name and fax number.
- Super fine resolution** 203 x 392 dpi. Best for very small print and line art.
- TAD (telephone answering device)** You can connect an external TAD to your fax machine.
- Telephone Answer Code (Fax/Tel mode only)** When the fax machine answers a voice call, it pseudo/double-rings. You can pick up at an extension phone by pressing this code (# 5 1).
- Tel-Index List** A listing of names and numbers stored in One-Touch and Speed-Dial memory, in alphabetical order.
- Tone** A form of dialling on the telephone line used for Touch Tone telephones.
- Transmission** The process of sending documents over the phone lines from the fax machine to a receiving fax machine.
- User Settings** A printed report that shows the current settings of the fax machine.
- XMIT Report (Transmission Verification Report)** A listing for each transmission, that shows its date, time and number.

S Specifications

General

| | |
|---|---|
| Type | Desktop facsimile transceiver |
| Memory Capacity | 512 KB |
| Paper Tray | 64 g/m ² – 90 g/m ² : Up to 30 sheets |
| Paper Output | 64 g/m ² – 90 g/m ² : Up to 20 sheets |
| Printer Type | Line Thermal with Ribbon |
| LCD (Liquid Crystal Display) | 16 characters x 1 Line |
| Operating Environment | Temperature: 10-35 °C Humidity: 20-80% |
| Best Print Quality | 20-30 °C |
| Power Source | 220-240V AC 50/60 Hz |
| Power Consumption | Standby: FAX-T104 under 4.4 watts FAX-T106 under 4.8 watts Operating: under 160 watts |

Dimensions

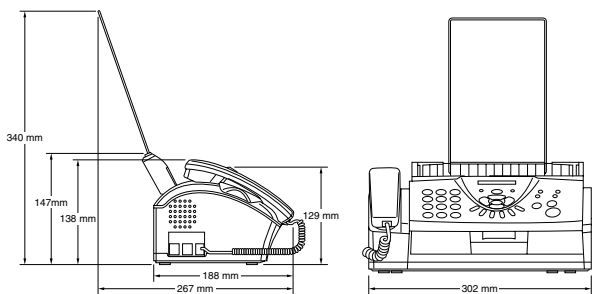

| | |
|---------------|--|
| Weight | FAX-T104 : 2.7 kg (with components) FAX-T106 : 2.8 kg (with components) |
|---------------|--|

Copy

| | |
|-----------------------|---|
| Enlarge/Reduce | 50% to 150% (50, 75, 87, 93, 100, 120, 125, 150% & Auto) |
|-----------------------|---|

Fax

| | |
|--|---|
| Compatibility | ITU-T Group 3 |
| Coding System | Modified Huffman (MH) |
| Modem Speed | 9600/7200/4800/2400 bps; Automatic Fallback (FAX-T104) 14400/12000/9600/7200/4800/2400 bps; Automatic Fallback (FAX-T106) |
| Document Size | Document Input Width 148 mm to 216 mm |
| Paper Size | A4 |
| Automatic Document Feeder (ADF) | Up to 10 pages |
| Gray Scale | 64 levels (Dithered) |
| Polling Types | Standard, Sequential, Secure, Delayed Fax |
| Contrast Control | Automatic/Light/Dark (manual setting) |
| Resolution | • Horizontal 8 dot/mm • Vertical Standard — 3.85 line/mm Fine, Photo — 7.7 line/mm Superfine, Photo (copy) — 15.4 line/mm |
| One-Touch Dial | 4 stations |
| Speed-Dial | 100 stations |
| Groups | Up to 4 groups |
| Broadcasting | Up to 104 locations |
| Automatic Redial | 3 times at 5 minutes intervals |
| Auto Answer | 0, 1, 2, 3 or 4 rings |
| Speaker Type | Monitor (FAX-T104) Full Duplex, Digital (FAX-T106) |
| Communication Source | Public switched telephone network |
| Memory Transmission | Up to 20 pages * |
| Out of Paper Reception | Up to 25 pages * |
| Refill Ribbon Rolls | Yield: Up to 144 pages (A4) |

* “Pages” refers to the ITU-T Test Chart #1 (in Out of Paper Reception in ECM mode). Specifications and printed materials are subject to change without prior notice.

Index

The items in all upper case represent LCD messages.

- A**
- ADF (automatic document feeder)6-2
- Answering machine (TAD) 1-9, 5-1
- Automatic
 - fax receive5-1
 - Fax Detect5-4
 - fax redial6-2
 - transmission6-2
- B**
- Backup Printing9-5
- Broadcasting6-8
 - setting up Groups7-3
- C**
- Call Back Message6-9
- Call Reservation6-9
- Caller ID 5-10–5-13
- Canceling
 - a scheduled fax job6-5
 - while scanning a fax6-5
- Cleaning13-8
 - print head13-8
 - scanner13-9
- Connecting
 - external TAD1-9
 - external telephone1-9
- Control panel overview 1-3–1-6
- Copy
 - multiple11-2
 - operations11-1
 - reduce/enlarge11-2
 - Resolution 11-1, 11-2
 - single 11-1, 11-2
 - sort11-2
 - specifications S-1
- Cover Page 6-6–6-8
- Custom telephone features 1-12, 13-7
- D**
- Date and Time4-1
- Delayed Fax6-10
- Dialling
 - a pause7-6
 - fax redial6-2
 - Groups7-3
 - manual7-4
 - Quick-Dial7-1
- E**
- ECM (Error Correction Mode)1-8
- Erasing Messages 9-3, 9-6
- Error messages on LCD 13-1–13-3
- Extension telephones 1-11
 - using5-6
- External telephone 1-9
- F**
- F/T (Fax/Tel) Outgoing Announcement (OGM) 5-3
- Fax codes
 - changing8-2, 9-8
 - Fax Receive Code5-6
 - Remote Access Code ...8-2, 9-8
 - Telephone Answer Code5-6
- Fax Detect5-4
- Fax Forwarding8-1, 9-2
 - changing remotely 8-4, 8-5, 9-8, 9-9
 - programming a number8-1, 9-2
- Fax Journal10-2
- Fax Receive Code5-3, 5-6, 5-7
- Fax Storage8-2, 9-2
 - Fax Forwarding8-1, 9-2
 - printing from memory5-8, 9-5
 - turning on8-2, 9-2
- Fax, stand-alone
 - receiving5-1
 - at end of conversation5-5
 - difficulties13-6
 - erasing from the memory8-4
 - Fax Forwarding8-1, 8-4, 9-2, 9-9
 - reducing to fit on paper ...5-4
 - retrieving from a remote site 8-4, 8-5, 9-8, 9-10
 - ring delay, setting5-2
 - sending
 - at end of conversation6-3
 - contrast6-4
 - delayed6-10
 - fax redial7-7
 - manual6-3
 - Memory Transmission ...6-12
 - multiple settings6-3
 - overseas6-8
 - Polling Transmit6-11
 - resolution6-4
 - specificationsS-2
- FAX/TEL mode5-1
 - answering at extension phones5-6
 - double-ringing (voice calls)5-3
 - Fax Detect5-4
 - Fax Receive Code5-7
 - receiving faxes5-6
 - setting F/T Ring Time5-3
 - Setting Ring Delay5-2
 - Telephone Answer Code5-6

G

Gray scale S-2

Groups, setting up 7-3

H

HELP

 Help List 10-2

 Hold 4-6, 7-6

I

ICM Recording Monitor 9-7

International calls 6-8

Interrupting (a scheduled job)
..... 6-13

J

Jams 13-4

L

LCD (Liquid Crystal Display)
..... 1-3, 1-5, 3-1

M

Maintenance, routine 13-8

 changing the ribbon 13-9

 cleaning the print head 13-8

Manual

 dialling 7-4

 receive 5-1

 transmission 6-3

Maximum Message Time 9-6

Melody 4-6

Memory Status List 10-2

Memory Storage 3-1

Menu Table 3-1, 3-3-3-7

Message Manager Mode 9-1

Mute 1-5, 7-6

N

Navigation keys 3-2

O

OGM (Outgoing Message) 9-3

One-Touch 1-4, 1-6

 changing 7-2

 dialling 7-5

 storing 7-1

P

Paper 2-1

 capacity 2-1

 size 2-1

Phone line

 connections 1-10

 difficulties 13-6

 multi-line (PABX) 1-12

Playing Messages 9-5

Polling 5-8

 Polling Transmit 6-11

 receiving 5-8

Power failure 3-1

Print

 Cover Page 6-8

 difficulties 13-6

 fax from memory 5-8, 9-5

 jams 13-5

Q

Quick-Dial 7-1

 Broadcasting 6-8

 using Groups 6-8

 Group dial

 setting up Groups for

 Broadcasting 7-3

 One-Touch dial

 changing 7-2

 setting up 7-1

 using 7-5

 Search 6-1

 Speed-Dial

 changing 7-2

 setting up 7-2

 using 7-5

Quick-Dial List 10-2

R

Receive Mode 5-2

 FAX ONLY 5-1

 FAX/TEL 5-1

 MANUAL 5-1

 TAD:ANSWER MACH. 5-1

 TAD:MSG MGR 5-1

Recording a Conversation 9-7

Recording Monitor 9-7

Redial/Pause 6-2, 6-9

Reducing

 copies 11-2

 long faxes 5-4

Remote Access Code 8-3, 9-8

Remote Commands

 8-4, 9-9, 9-10

Remote Retrieval 8-3, 9-8

 access code 8-2, 8-3, 9-8

 commands 8-4, 9-9, 9-10

 getting your faxes 8-5, 9-10

Reports 10-2

 Fax Journal 10-2

 Journal Period 10-1

 Help List 10-2

 Memory Status 10-2

 Quick-Dial List 10-2

 Tel.Index 10-2

 Transmission Verification

 10-1

 User Settings 10-2

Resolution

 copy 11-2

 fax (Standard, Fine,
 SuperFine, Photo) S-2

 for next fax only 6-4

 multiple 6-5

Ring Delay, setting 5-2

Ring Pattern 4-6

Ring Volume 4-5

S

| | |
|-------------------------------|---------------|
| Safety instructions | iii, 12-1 |
| Search | 7-6 |
| Sequential Polling | 5-9 |
| Setup | |
| Date and Time | 4-1 |
| Station ID (fax header) | 4-2 |
| Socket | |
| EXT socket | |
| external telephone | 1-9 |
| TAD (answering machine) | |
| | 1-9 |
| Speaker Phone | 7-6 |
| Speed-Dial | 1-4, 1-6, 7-5 |
| changing | 7-2 |
| dialling | 7-5 |
| storing | 7-2 |

T

| | |
|-----------------------------------|-----------|
| TAD (telephone answering device), | |
| external | 5-1 |
| connecting | 1-9 |
| Receive Mode | 5-1 |
| TAD MESSAGE | 9-3 |
| Temporary Cover Page | 6-7 |
| Text, entering | 4-3 |
| special characters | 4-3 |
| Toll Saver | 9-7 |
| Tone signals on Pulse line | 7-7 |
| Troubleshooting | 13-1 |
| error messages on LCD | |
| | 13-1–13-3 |
| if you are having difficulty | |
| incoming calls | 13-7 |
| phone line difficulties | 13-6 |
| printing or receiving faxes | |
| | 13-6 |
| sending faxes | 13-6 |
| Turning | 6-14 |
| TX Lock | 6-13–6-14 |

U

| | |
|--------------------------|------|
| User Settings List | 10-2 |
|--------------------------|------|

V

| | |
|-----------------|-----|
| Volume, setting | |
| beeper | 4-4 |
| ring | 4-5 |
| speaker | 4-4 |

Accessory List

| Model Name | Description |
|------------|---|
| PC-75 | Print Cartridge (1 set per box) |
| PC-71RF | 1 re-fill for use in PC-75 Print Cartridge |
| PC-72RF | 2 re-fills for use in PC-75 Print Cartridge |
| PC-74RF | 4 re-fills for use in PC-75 Print Cartridge |

*For optimum print quality and product performance within published specifications, use only the correct Brother replacement ribbon.

| | |
|---|---|
| <p>Change Receive Mode Press 9 8. <i>then for TAD, press 1.</i> <i>then for FAX/TEL, press 2.</i> <i>FAX ONLY, press 3.</i></p> <p>Exit Remote Operation Press 9 0.</p> <p>Change Remote Access Code</p> <ol style="list-style-type: none"> Press Menu/Set, 8 2. Enter a three-digit number. The * cannot be changed. Press Menu/Set. Press Stop/Exit. <p>(For FAX-T104)→</p> | <p>REMOTE CONTROL ACCESS CARD</p> <p>Using Remote Access Code</p> <ol style="list-style-type: none"> Dial your machine phone number from a touch tone phone. Enter your Remote Control Access Code (3 digits followed by *) after the beep. Your machine signals the kinds of messages received: 1 long beeps – Fax message(s) No beeps – no messages After 2 short beeps, enter a command. Press 9 0 to reset your machine when you finish. Hang up. |
| <p>Retrieve a Fax Press 9 6. <i>then to Print a Memory Status List press</i></p> <ol style="list-style-type: none"> then enter the number of remote fax machine, and then # # . After the beep, hang up and wait. <p>Retrieve all faxes press 2, then enter the number of remote fax machine, and then # # . After the beep, hang up and wait.</p> <p>Erase all fax messages press 3.</p> <p>Check Receiving Status Press 9 7. <i>then for Fax message, press 1.</i> <i>Voice message, press 2.</i></p> <ol style="list-style-type: none"> long beeps – received messages short beeps – no messages <p>(For FAX-T106)</p> | <p>MESSAGE MANAGER</p> <p>REMOTE CONTROL ACCESS CARD</p> <p>Using Remote Access Code</p> <ol style="list-style-type: none"> Dial your fax machine phone number from a touch tone phone. Enter your Remote Access Code (3 digits followed by *) after the beep. The fax machine signals the kinds of messages received: 1 long beep – Fax message(s) 2 long beeps – Voice message(s) 3 long beeps – Fax and Voice message(s) No beeps – no messages After 2 short beeps, enter a command. Press 9 0 to reset the machine when you finish. Hang up. |
| <p>Change Receive Mode Press 9 8. <i>then for TAD:MSG MGR, press 1.</i> <i>FAX ONLY, press 2.</i> <i>FAX ONLY, press 3.</i></p> <p>Exit Remote Operation Press 9 0.</p> | <p>Change Receive Mode Press 9 8. <i>then for TAD:MSG MGR, press 1.</i> <i>FAX ONLY, press 2.</i> <i>FAX ONLY, press 3.</i></p> <p>Exit Remote Operation Press 9 0.</p> |

Remote Commands

Change Fax Forwarding Setting

- Press **9 5**.
- Then to* Turn feature off press **1**.
- Enter Fax Forwarding press **2**.
- Program Fax Forward Number press **4**. Enter the new number of the remote fax machine where you want your fax messages forwarded, and then press **# #**. Press **9 6 1** after two short beeps, then enter the number of remote fax machine, and then **# #** to retrieve Memory Status List.
- Turn Fax Storage on press **6**.

Retrieve a Fax

- Press **9 6**.
- Then to* Print a Memory Status List press **1**, then enter the number of remote fax machine, and then **# #**.
- After the beep, hang up and wait.
- Retrieve all faxes press **2**, then enter the number of remote fax machine, and then **# #**. After the beep, hang up and wait.
- Erase all fax messages press **3**.
- Press **9 7 1**.
- Check the Receiving Status**
- 1** long beep – Fax message(s)
- 3** short beeps – no messages

Changing Remote Access Code

- 1 Press Menu/Set **8 7**.
- 2 Enter a three-digit code using number keys 0-9. The * cannot be changed.
- 3 Press Menu/Set
- 4 Press Stop/Exit

Remote Commands

Listen to Voice Messages

- Press **9 1**.
- Then to* Repeat a message press **1**.
- Skip to next message, press **2**.
- Stop playing the message press **9**

Erase All Voice Messages

- Press **9 3**. If you hear three beeps, all messages have not yet been heard, and the messages will not be erased.

Play/Record Outgoing Message

- Press **9 4**.
- Then to* Play TAD MESSAGE press **1 1**.
- Play FT MESSAGE press **1 2**.
- Record new TAD MESSAGE
- press **2 1**, then speak after beep.
- press **9** to stop.
- Record new FT MESSAGE
- press **2 2**, then speak after beep.
- press **9** to stop.

Change Fax Forwarding Setting

- Press **9 5**.
- Then to* Turn feature off press **1**.
- Enter Fax Forwarding press **2**.
- Program Fax Forward Number press **4**. Enter the new number of the remote fax machine where you want your fax messages forwarded, and then press **# #**.
- Press **9 6 1** after two short beeps, then enter the number of remote fax machine, and then **# #** to retrieve Memory Status List.

At your side.
brother®

This machine is approved for use in the country of purchase only, local Brother companies or their dealers will only support fax machines purchased in their own countries.



UK/IRE
LF3812004