

# HP MSM APs Configuration Guide

## Abstract

This document describes how to configure and manage these access points operating in autonomous mode: MSM410, MSM422, MSM430, MSM460, MSM466, MSM466-R, and HP 560.



© Copyright 2014 Hewlett-Packard Development Company, L.P.

The information contained herein is subject to change without notice. The only warranties for HP products and services are set forth in the express warranty statements accompanying such products and services. Nothing herein should be construed as constituting an additional warranty. HP shall not be liable for technical or editorial errors or omissions contained herein.

#### Acknowledgments

Microsoft®, Windows®, and Windows XP® are U.S. registered trademarks of the Microsoft group of companies. Java® is a registered trademark of Oracle and/or its affiliates. Apple® and Bonjour® are trademarks of Apple Inc.



#### Warranty

WARRANTY STATEMENT: See the warranty information sheet provided in the product box.

---

# Contents

<b>1</b>	<b>Introduction.....</b>	<b>7</b>
	New in release 6.5.0.x.....	7
<b>2</b>	<b>Using the management tool.....</b>	<b>8</b>
	Starting the management tool.....	8
	Setting up manager and operator accounts.....	8
	Administrative user authentication.....	10
	Passwords.....	10
	Configuring management tool security.....	11
	Configuring the Login page message.....	12
	Configuring Auto-refresh.....	12
	Setting the system time.....	12
	LEDs.....	13
	Country.....	13
<b>3</b>	<b>Network configuration.....</b>	<b>14</b>
	Working with network profiles.....	14
	To define a new network profile.....	14
	Configuring IP interfaces.....	14
	To assign an IP address to a new interface.....	15
	Configuring the Bridge interface.....	17
	Configuring port settings.....	19
	Bandwidth control.....	19
	Discovery protocols.....	20
	CDP configuration.....	20
	LLDP configuration.....	20
	DNS configuration.....	23
	DNS servers.....	24
	DNS advanced settings.....	24
	Defining IP routes.....	25
	Configuring IP routes.....	25
	IP QoS.....	26
	Configuring IP QoS profiles.....	26
	Example.....	27
	Customizing DiffServ DSCP mappings.....	29
	802.1X supplicant.....	29
	Important.....	29
	EAP Method.....	30
	Username.....	30
	Password / Confirm password.....	30
	Anonymous.....	30
<b>4</b>	<b>Wireless configuration.....</b>	<b>31</b>
	Wireless coverage.....	31
	Factors limiting wireless coverage.....	31
	Configuring overlapping wireless cells.....	32
	Automatic transmit power control.....	35
	Supporting 802.11a and legacy wireless clients.....	35
	Radio configuration.....	36
	Radio configuration parameters.....	37
	Advanced wireless settings.....	45
	Neighborhood scanning.....	49
	Wireless neighborhood.....	50

Scanning modes.....	50
Viewing scan results.....	51
Identifying unauthorized APs.....	52
Viewing wireless information.....	52
Viewing all wireless clients.....	52
Viewing wireless client data rates.....	54
Wireless access points.....	57
<b>5 Working with VSCs.....</b>	<b>62</b>
Key concepts.....	62
Stand-alone deployment.....	62
Deployment with a controller.....	63
Management with VLANs.....	64
Viewing and editing VSC profiles.....	64
VSC configuration options.....	65
General.....	66
Virtual AP.....	68
Egress VLAN.....	72
Wireless security filters.....	72
Wireless protection.....	74
Protected Management Frames (802.11w).....	76
MAC-based authentication.....	77
Location-aware.....	77
MAC filter.....	78
IP filter.....	78
VSC data flow.....	79
Stand-alone deployment.....	79
AP deployed with a controller.....	79
Quality of service.....	80
Priority mechanisms.....	81
IP QoS profiles.....	82
Upstream DiffServ tagging.....	82
Upstream/downstream traffic marking.....	83
<b>6 Events.....</b>	<b>85</b>
Filter events by.....	85
Table.....	85
Severity.....	85
ID.....	86
Device.....	86
Category.....	86
Type.....	86
Alarm.....	86
Description.....	86
Timestamp.....	86
Button.....	87
Export.....	87
Configuring SNMP notifications for events.....	87
<b>7 Working with VLANs.....</b>	<b>89</b>
Defining a VLAN on a port.....	89
Defining an egress VLAN for a VSC.....	90
Configuring a default VLAN.....	90
Assigning VLANs to individual users.....	91
VLAN bridging.....	91

<b>8 Authentication services</b> .....	<b>92</b>
Using a third-party RADIUS server.....	92
Configuring a RADIUS server profile.....	92
Authenticating manager logins using a third-party RADIUS server.....	94
Configuring user accounts on a RADIUS server.....	95
Configuring administrative accounts on a RADIUS server.....	100
<b>9 Security</b> .....	<b>102</b>
Managing certificates.....	102
Trusted CA certificate store.....	102
Certificate and private key store.....	103
Certificate usage.....	105
About certificate warnings.....	106
Certificate expiration alerts.....	106
MAC lockout.....	107
Configuring MAC lockout.....	107
Configuring MAC address lists.....	107
Matching MAC addresses.....	108
<b>10 Local mesh</b> .....	<b>109</b>
Key concepts.....	109
Simultaneous AP and local mesh support.....	109
Using 802.11ac/n/a for local mesh.....	110
Local mesh link types.....	110
Static local mesh links.....	110
Dynamic local mesh links.....	111
Quality of service.....	113
Maximum range (ack timeout).....	114
Local mesh profiles.....	115
Configuring a local mesh profile.....	116
Sample local mesh deployments.....	119
RF extension.....	119
Building-to-building connection.....	119
Dynamic network.....	120
<b>11 Maintenance</b> .....	<b>122</b>
Config file management.....	122
Manual configuration file management.....	122
Scheduled operations.....	123
Software updates.....	123
Performing an immediate software update.....	124
Performing a scheduled software update.....	125
<b>12 Support and other resources</b> .....	<b>126</b>
Online documentation.....	126
Contacting HP.....	126
HP websites.....	126
Typographic conventions.....	126
<b>A Console ports</b> .....	<b>127</b>
Console port connector specifications.....	127
MSM422 console port.....	127
MSM410, MSM430, MSM460, and MSM466 console port.....	127
<b>B Resetting to factory defaults</b> .....	<b>128</b>
Read this before resetting to factory defaults.....	128
Resetting to factory defaults.....	128
Using the reset button.....	128

Using the management tool.....	128
Disabling the reset button on an AP.....	130
<b>C Connecting external antennas.....</b>	<b>131</b>
Introduction.....	131
802.11n MIMO antennas for the MSM466 and MSM466-R.....	131
802.11a/b/g antennas for MSM APs.....	131
Radio power-level setting example.....	132

# 1 Introduction

This guide describes how to configure and manage these access points operating in autonomous mode: MSM410, MSM422, MSM430, MSM460, MSM466, MSM466-R, and HP 560. For instructions on working with these APs when operating in controlled mode, see the *MSM7xx Controllers Configuration Guide*.

**NOTE:** The following APs do not support autonomous mode: MSM310, MSM310-R, MSM320, MSM320-R, MSM325, HP 317, and HP 425.

## New in release 6.5.0.x

Information on what is new and changed in release 6.5.0.x is located as follows:

New or changed in this release	For information, see...
<b>New AP:</b> This release adds support for the HP 560, a dual-band 802.11a/b/g/n/ac access point.	See the installation guide for the HP 560.
<b>802.11w support:</b> This new VSC configuration option provides enhanced security for WPA2 traffic by protecting unicast and multicast management action frames. (HP 560 only.)	<a href="#">“Protected Management Frames (802.11w)” (page 76)</a>
<b>Load on reboot:</b> This new feature enables a firmware update to occur automatically when an AP is restarted.	<a href="#">“Performing a scheduled software update” (page 125)</a>

---

## 2 Using the management tool

### Starting the management tool

Using Microsoft Internet Explorer 8+ or Mozilla Firefox 3+ (with SSL v3 support enabled), open page: **https://192.168.1.1** and then log in. This assumes you are connected to the LAN port on the controller (ports 1, 2, 3, or 4 on the MSM720).

---

#### About passwords:

The default username and password is **admin**. New passwords must be 6 to 16 printable ASCII characters in length with at least 4 different characters. Passwords are case sensitive. Space characters and double quotes ( " ) cannot be used. Passwords must also conform to the selected security policy as described in "Passwords" (page 10).

#### About the security warning:

A security certificate warning is displayed the first time that you connect to the management tool. This is normal. Select whatever option is needed in your Web browser to continue to the management tool. The default certificate provided with the AP will trigger a warning message on most browsers because it is self-signed. To remove this warning message, you must replace the default certificate. See "Managing certificates" (page 102).

---

### Setting up manager and operator accounts

Two types of administrative user accounts are defined on the AP: manager and operator.

- The manager account provides full management tool rights.
- The operator account provides read-only rights plus the ability to disconnect wireless clients and perform troubleshooting.

To configure the accounts, select **Management > Management tool**.



### Management tool configuration

#### Administrative user authentication ?

Local

RADIUS: <No RADIUS defined>

#### Manager account ?

Username:

Current password:

New password:

Confirm new password:

---

If a manager is logged in, then a new manager login:

Terminates the current manager session

Is blocked until the current manager logs out

#### Operator account ?

Username:

New password:

Confirm new password:

---

If an operator is logged in, then a new operator login:

Terminates the current operator session

Is blocked until the current operator logs out

#### Login control ?

Lock access after  login failures

Lock access for  minutes

#### Login message ?

Login message:

```
Authorized access only.
This system is property of [COMPANY
NAME].
Contact [EMAIL] for more information.
```

#### Security policies ?

Follow FIPS 140-2 guidelines

Follow PCI DSS 1.2 guidelines

#### Security ?

Access to the management tool is enabled for the addresses and interfaces that are specified below.

**Allowed addresses:**

IP address:  Mask:

**Active Interfaces:**

Port 1

Wireless ports

#### Web server ?

Secure web server port:

Web server port:

#### Auto-Refresh ?

Interval:  seconds

#### Account inactivity logout ?

Timeout:  minutes

Only one administrator (manager or operator) can be logged in at any given time. Options are provided to control what happens when an administrator attempts to log in while another administrator (or the same administrator in a different session) is already logged in. In every case, the manager's rights supersede those of an operator.

The following options can be used to prevent the management tool from being locked by an idle manager or operator:

- **Terminates the current manager session:** When enabled, an active manager or operator session will be terminated by the login of another manager. This prevents the management tool from being locked by an idle session until the **Account inactivity logout** timeout expires.
- **Is blocked until the current manager logs out:** When enabled, access to the management tool is blocked until an existing manager logs out or is automatically logged out due to an idle session.

- **Terminates the current operator session:** When enabled, an active operators session will be terminated by the login of another operator. This prevents the management tool from being locked by an idle session until the **Account inactivity logout** timeout expires.  
Operator access to the management tool is blocked if a manager is logged in. An active manager session cannot be terminated by the login of an operator.
- **Is blocked until the current operator logs out:** When enabled, access to the management tool is blocked until an existing operator logs out or is automatically logged out due to an idle session.
- **Login control:** If login to the management tool fails five times in a row (bad username and/or password), login privileges are blocked for five minutes. Once five minutes expires, login privileges are once again enabled. However, if the next login attempt fails, privileges are again suspended for five minutes. This cycle continues until a valid login occurs. You can configure the number of failures and the timeout.
- **Account inactivity logout:** By default, if a connection to the management tool remains idle for more than ten minutes, the controller automatically terminates the session. You can configure the timeout.

---

**NOTE:** An operator session is always terminated if a manager logs in. An active operator session cannot block a manager from logging in.

---

## Administrative user authentication

Login credentials can be verified using local account settings and/or an external RADIUS sever. This also affects how many accounts you can have.

- **Local:** Select this option to use a single manager and operator account. Configure the settings for these accounts under **Manager account** and **Operator account**.
- **RADIUS:** Using a RADIUS server enables you to have multiple manager and operator accounts, each with a unique username and password. To setup this option, see [“Authenticating manager logins using a third-party RADIUS server” \(page 94\)](#).

If both options are enabled, the RADIUS server is always checked first.

## Passwords

Passwords must be 6 to 16 printable ASCII characters in length with at least 4 different characters. Passwords are case sensitive. Space characters and double quotes ( " ) cannot be used. Passwords must also conform to the selected security policy as follows.

- **Follow FIPS 140-2 guidelines:** When selected, implements the following requirements from the FIPS 140-2 guidelines:
  - All administrator passwords must be at least six characters long.
  - All administrator passwords must contain at least four different characters.

For more information on these guidelines, refer to the *Federal Information Processing Standards Publication (FIPS PUB) 140-2, Security Requirements for Cryptographic Modules*.
- **Follow PCI DSS 1.2 guidelines:** When selected, implements the following requirements from the PCI DSS 1.2 guidelines:
  - All administrator passwords must be at least seven characters long.
  - All administrator passwords must contain both numeric and alphabetic characters.

- The settings under **Login control** must be configured as follows:
  - **Lock access after *nn* login failures** must be set to 6 or less.
  - **Lock access for *nn* minutes** must be set to 30 minutes or more.
- The settings under **Account inactivity logout** must be configured as follows:
  - **Timeout** must be set to 15 minutes or less.

For more information on these guidelines, refer to the Payment Card Industry Data Security Standard v1.2 document.

## Configuring management tool security

Select **Management > Management tool** and configure the settings under **Security**.

### Allowed addresses

Enables you to define a list of IP address from which to permit access to the management tool. To add an entry, specify the IP address and appropriate mask and select **Add**. When the list is empty, access is permitted from any IP address. For example: To allow access for a single computer with IP address 192.168.1.209, specify:

IP address = 192.168.1.209

Mask = 255.255.255.255

To allow access for several computers in the IP address range 192.168.10.16 to 192.168.10.31, specify:

IP address = 192.168.10.16

Mask = 255.255.255.240

### Active interfaces

Select the interfaces through which access to the management tool will be permitted. (These settings also apply when SSH is used to access the command line interface.)

---

**⚠ CAUTION:** It is possible to lose access to the AP if you add the wrong IP address or address range to the list. Make sure that the IP address or address range you add matches that of your computer. If you lose access, you will need to reset the AP to its factory default settings as described in the installation guide.

---

## Configuring the Login page message

You can customize the message that is displayed at the top of the login page by selecting **Management > Management tool** and entering a new message under **Login message**.

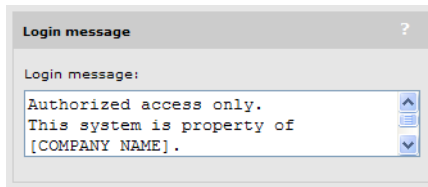

## Configuring Auto-refresh

Select **Management > Management tool** and configure the settings under **Auto-Refresh**.

This option controls how often the AP updates the information in group boxes that show the auto-refresh icon in their title bar. Under **Interval**, specify the number of seconds between refreshes.

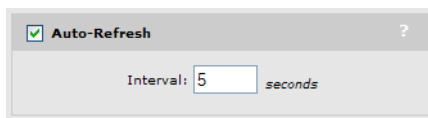

## Setting the system time

Select **Management > System time** to open the **System time** page. This page enables you to configure the time server and time zone information.

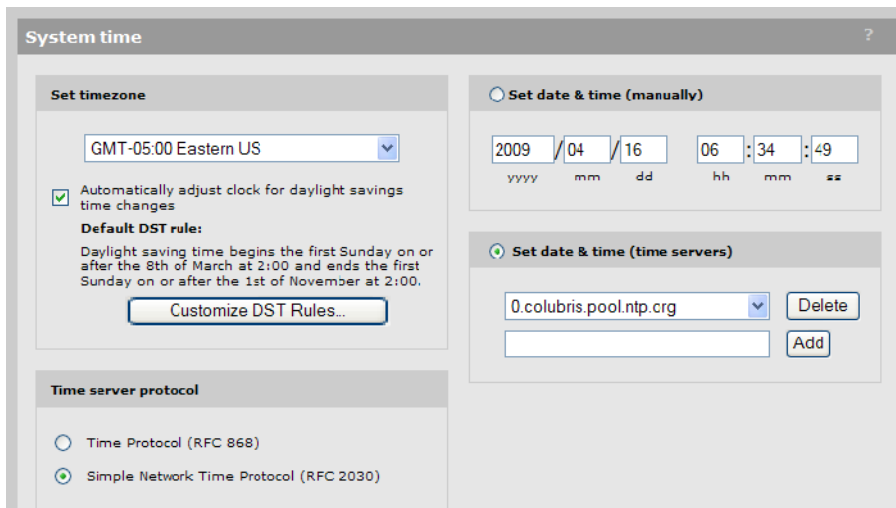

1. Set **timezone & DST** as appropriate.
2. Set **Time server protocol**, to **Simple Network Time Protocol**.
3. Select **Set date & time (time servers)** and then select the desired time server. **Add** other servers if desired. The AP contacts the first server in the list. If the server does not reply, the AP tries the next server and so on. By default, the list contains two ntp vendor zone pools that are reserved for HP networking devices. By using these pools, you will get better service and keep from overloading the standard ntp.org server. For more information visit: [www.pool.ntp.org](http://www.pool.ntp.org).
4. Select **Save** and verify that the date and time is updated accurately. A working Internet connection on Port 1 is required.

---

**NOTE:** If access to the Internet is not available to the AP, you can temporarily set the time manually with the **Set date & time (manually)** option. However, it is important to configure a reliable time server on the AP.

---

## LEDs

Select **Management > LEDs** to control operation of the status lights on the AP after the AP has successfully started up and become fully operational.

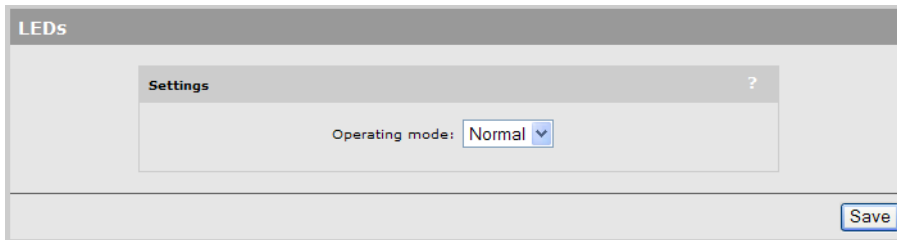

LEDs

Settings ?

Operating mode: Normal

Save

Until fully operational, status lights follow their normal behavior. This allows potential error conditions to be diagnosed.

The following settings are available:

- **Normal:** All status lights on the AP operate normally.
- **Quiet:** All status lights on the AP are turned off once the AP is fully operational.
- **Awake:** The power light flashes once per minute once the AP is fully operational.

## Country

Select **Management > Country** to open the Country page. This page enables you to configure the country in which the AP operates.

---

**NOTE:** The Country page is not available on APs delivered with a fixed country setting.

---

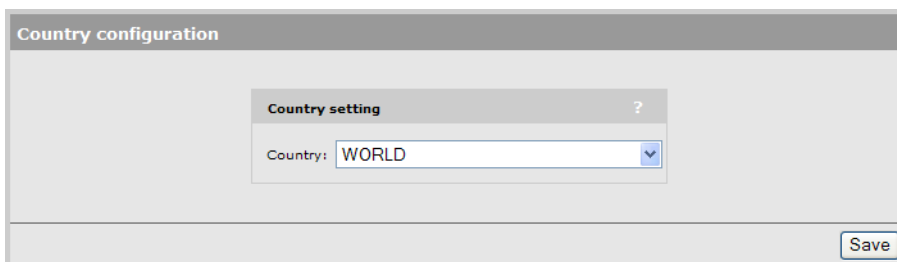

Country configuration

Country setting ?

Country: WORLD

Save

Set the country in which the AP will operate. This enables the AP to properly customize the list of operating frequencies (channels) that you can configure on the **Wireless > Radio(s)** page. Only frequencies that conform to the regulations in your area will be available.

## 3 Network configuration

### Working with network profiles

The AP uses logical entities called network profiles to manage the configuration of network settings. Network profiles let you define the characteristics of a network and assign a friendly name to it. Once defined, network profiles can then be bound to a port, or VLAN as required. Network profiles make it easy to use the same settings in multiple places on the AP.

For example, if you define a network profile with a VLAN ID of 10, you could use that profile to:

- Map VLAN 10 to an AP port using the **Network > VLANs** page.
- Set VLAN 10 as the egress network for a VSC using the **VSC > Profiles** page.

### To define a new network profile

1. Select **Network > Network profiles**.

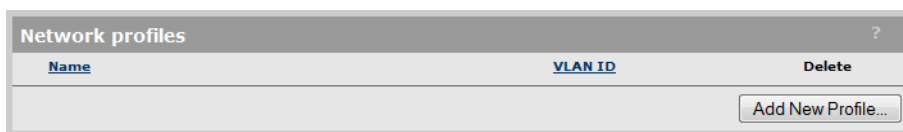

2. Select **Add New Profile**.

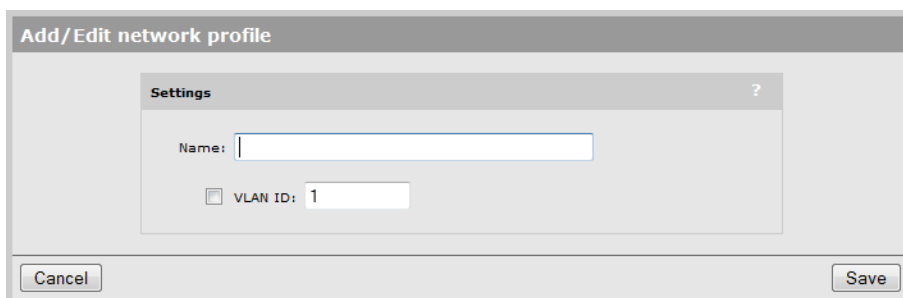

3. Configure profile settings as follows:

- Under **Settings**, specify a **Name** for the profile.
- Optionally, assign a **VLAN ID**. Select **VLAN ID** and then specify a number. You can also define a range of VLANs in the form **X-Y**, where **X** and **Y** can be 1 to 4094. For example: 50-60. An IP address cannot be assigned to a VLAN range. You can define more than one VLAN range by using multiple profiles. Each range must be distinct and contiguous.

4. Select **Save**.

### Configuring IP interfaces

The IP interfaces page lists all network profiles to which an IPv4 address is assigned. To open the IP interfaces page, select **Network > IP interfaces**.

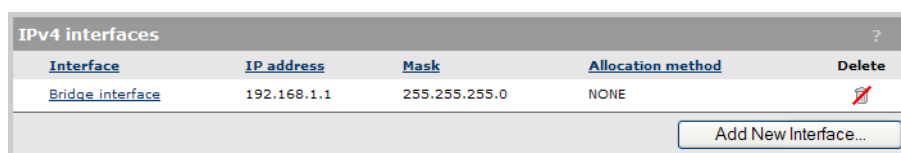

The Bridge interface is created by default. It can be edited, but not deleted. It is mapped to the wireless port and all Ethernet port(s) on the AP. (These ports are bridged and share the same IP address.)

## To assign an IP address to a new interface

Any network profile that has a VLAN ID and is mapped to a physical port can have an IP address assigned to it. The following steps illustrate how to create a new profile and assign an IP address to it.

1. Select **Network > Network profiles**.
2. Select **Add New Profile**.
3. Specify a name for the profile and assign a VLAN ID to it. This example uses the profile name **Network A** and a VLAN ID of **25**. Select **Save**.

**Add/Edit network profile**

Settings

Name:

VLAN ID:

4. Select **Network > VLANs** to open the VLANs page.

**VLANs**

Number of matching VLANs: 1 [Show all VLANs](#)

Filter VLANs by: Network profile

Select the action to apply to the selected network profiles: -- Select an Action --

<input type="checkbox"/>	Network profile	VLAN ID	Location	Tagged	Untagged
<input type="checkbox"/>	Network_A	25	None		

5. Select the new profile in the table to open the Add/Edit VLAN mapping page.

**Add/Edit VLAN mapping**

Selected network profiles

Network profile	VLAN ID
Network A	25

Map to

Port:

6. Select the port to which you want to map the profile (in this case **Port 1**).

7. Select **Save**. The profile is mapped to Port 1 tagged.

Network profile	VLAN ID	Location	Tagged	Untagged
<input type="checkbox"/> Network_A	25	Local	Port 1	

8. Select **Network > IP interfaces** to open the IPv4 interfaces page.

Interface	IP address	Mask	Allocation method	Delete
<a href="#">Bridge interface</a>	192.168.1.1	255.255.255.0	NONE	

9. Select **Add New Interface** to open the Add/Edit interface page.

10. Under **Interface**, select the network profile that you defined earlier.
11. Under **Assign IP address via**, select the addressing method to use.
  - **DHCP client:** Dynamic host configuration protocol. The DHCP server will automatically assign an address to the network profile, which functions as a DHCP client.
  - **Static:** Specify an **IP address**, **Mask**, and **Gateway**.
12. Select **Save**.
13. The new interface is added to the IPv4 interfaces table.

Interface	IP address	Mask	Allocation method	Delete
<a href="#">Bridge interface</a>	192.168.1.1	255.255.255.0	NONE	
<a href="#">Network A (25)</a>	0.0.0.0	0.0.0.0	DHCP	



## Configuring the Bridge interface

All wireless and Ethernet ports on an AP are bridged. As a result, they all share the same configuration settings defined by the Bridge interface. The following configuration options are available if you select the **Bridge interface** in the table.

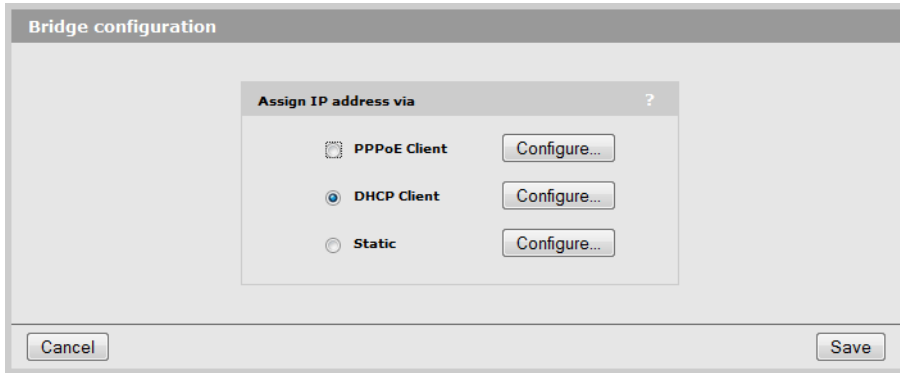

The image shows a dialog box titled "Bridge configuration". Inside, there is a section titled "Assign IP address via" with a question mark icon. This section contains three radio button options, each with a "Configure..." button to its right:

- PPPoE Client
- DHCP Client
- Static

At the bottom of the dialog box, there are "Cancel" and "Save" buttons.

By default, the Bridge interface operates as a DHCP client. Select the option you want to use and select **Configure**. Refer to the following sections for additional configuration information.

- "Configuring the PPPoE client" (page 17)
- "Configuring the DHCP client" (page 18) (default setting)
- "Static addressing" (page 19)

## Configuring the PPPoE client

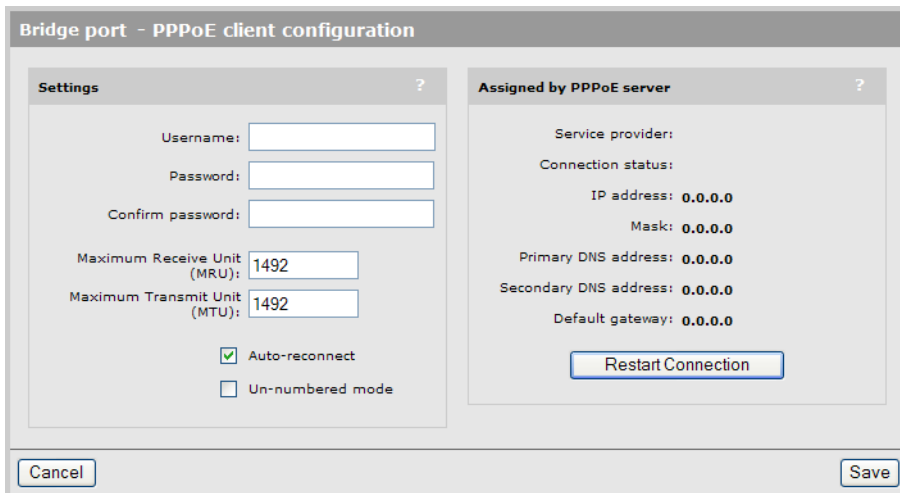

The image shows a dialog box titled "Bridge port - PPPoE client configuration". It is divided into two main sections:

- Settings**: Contains input fields for Username, Password, and Confirm password. Below these are fields for Maximum Receive Unit (MRU) and Maximum Transmit Unit (MTU), both set to 1492. At the bottom of this section are two checkboxes: "Auto-reconnect" (checked) and "Un-numbered mode" (unchecked).
- Assigned by PPPoE server**: Displays the following information:
  - Service provider:
  - Connection status:
  - IP address: 0.0.0.0
  - Mask: 0.0.0.0
  - Primary DNS address: 0.0.0.0
  - Secondary DNS address: 0.0.0.0
  - Default gateway: 0.0.0.0A "Restart Connection" button is located below this information.

At the bottom of the dialog box, there are "Cancel" and "Save" buttons.

1. Under **Settings**, define the following:
  - **Username:** Specify the username assigned to you by your ISP. The AP will use this username to log on to your ISP when establishing a PPPoE connection.
  - **Password/Confirm password:** Specify the password assigned to you by your ISP. The AP will use this password to log on to your ISP when establishing a PPPoE connection.
  - **Maximum Receive Unit (MRU):** Maximum size (in bytes) of a PPPoE packet when receiving. Changes to this parameter only should be made according to the recommendations of your ISP. Incorrectly setting this parameter can reduce the throughput of your Internet connection.
  - **Maximum Transmit Unit (MTU):** Maximum size (in bytes) of a PPPoE packet when transmitting. Changes to this parameter should only be made according to the recommendations of your ISP. Incorrectly setting this parameter can reduce the throughput of your Internet connection.
  - **Auto-reconnect:** The AP will automatically attempt to reconnect if the connection is lost.
  - **Un-numbered mode:** This feature is useful when the AP is connected to the Internet and NAT is not being used. Instead of assigning two IP addresses to the AP, one to the Internet port and one to the LAN port, both ports can share a single IP address.

This is especially useful when a limited number of IP addresses are available to you.

2. Under **Assigned by PPPoE server**, select **Restart Connection**. Once you are connected to the server, the following fields will display information about your connection. The Internet connection is not active until this occurs. Refer to the online help for a description of each field.

## Configuring the DHCP client

The screenshot shows a window titled "Bridge port - DHCP client configuration". It is divided into two main panels. The left panel, titled "Settings", contains a text input field for "DHCP Client ID" with the value "R007-00001" and a "(optional)" label. The right panel, titled "Assigned by DHCP server", displays several fields: "Domain name:", "IP address: 192.168.5.76", "Mask: 255.255.255.0", "Primary DNS address:", "Secondary DNS address:", "Default gateway:", and "Expiration time:". Below these fields are two buttons: "Release" and "Renew". At the bottom of the dialog are "Cancel" and "Save" buttons.

The DHCP client does not require any configuration, unless you need to set a value for the optional **DHCP Client ID** parameter for proper operation with your DHCP server.

Once you are connected to the server, the fields under **Assigned by DHCP server** show the settings assigned to the AP by the DHCP server. The connection is not active until this occurs. Refer to the online help for a description of each field.

If you want to force the DHCP client to obtain a new lease, select **Release** and then **Renew**.

## Static addressing

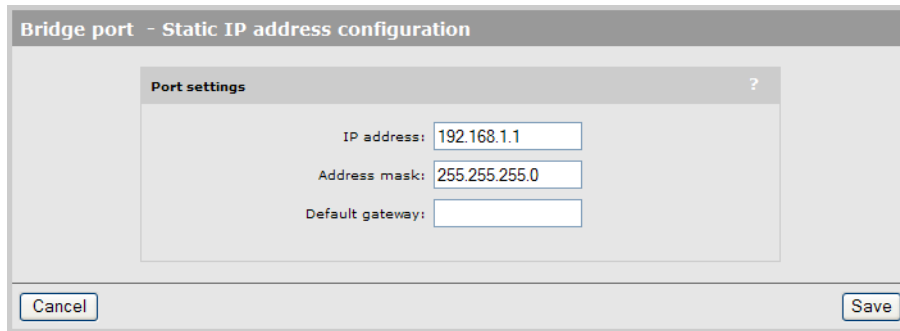

Bridge port - Static IP address configuration

Port settings ?

IP address: 192.168.1.1

Address mask: 255.255.255.0

Default gateway:

Cancel Save

Under **Port settings**, define the following:

- **IP address:** Specify the static IP address you want to assign to the port.
- **Address mask:** Specify the appropriate mask for the IP address you specified.
- **Default gateway:** Specify the address of the default gateway on the network.

## Configuring port settings

To configure settings for the physical ports on the AP, select **Network > Ports**.

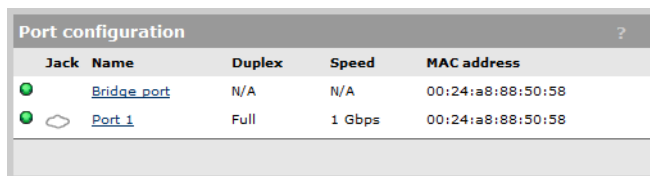

Jack	Name	Duplex	Speed	MAC address
●	<a href="#">Bridge port</a>	N/A	N/A	00:24:a8:88:50:58
●	<a href="#">Port 1</a>	Full	1 Gbps	00:24:a8:88:50:58

### Status light

- **Green:** Port is properly configured and ready to send and receive data.
- **Red:** Port is not properly configured or is disabled.

### Jack

Indicates the jack (physical interface) to which a port is assigned.

### Name

Identifies the port.

### Duplex

Indicates if the port is Full or Half duplex.

### Speed

Indicates the speed at which the port is operating.

### MAC address

Indicates the MAC address of the port.

## Bandwidth control

The AP incorporates a bandwidth management feature that provides control of outgoing user traffic on the wireless ports.

To configure bandwidth control, select **Network > Bandwidth control**.

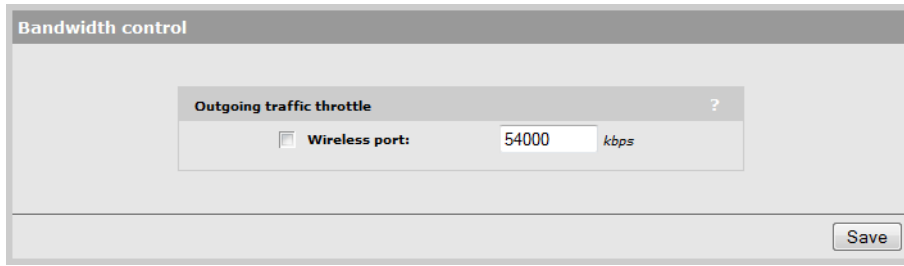

- If outgoing traffic arrives at the rate defined by the specified bandwidth limit (or less), it is processed without delay.
- If outgoing traffic arrives at a rate that is greater than the defined bandwidth limit, it causes the AP to throttle the traffic. If the traffic rate is over-limit for just a short burst, the data will be queued and forwarded without loss. If the traffic rate is over-limit for a sustained period, the AP will drop data to bring the rate down to the bandwidth limit that is set.

For example, if you set bandwidth control to 5000 kbps, the maximum rate at which traffic can be sent to wireless client stations is 5000 kbps.

## Discovery protocols

The controller supports two protocols (LLDP and CDP) that provide a mechanism for devices on a network to exchange information with their neighbors.

To configure these protocols, select **Network > Discovery protocols**.

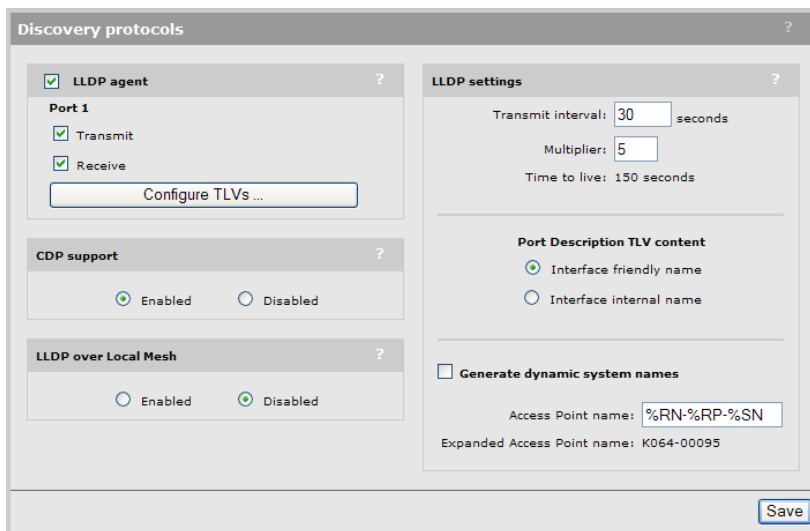

## CDP configuration

The AP can be configured to transmit CDP (Cisco Discovery Protocol) information on all ports. This information is used to advertise AP information to third-party devices, such as CDP-aware switches.

When installed with a controller, the controller uses CDP information sent by autonomous APs to collect information about these APs for display in its management tool.

## LLDP configuration

The IEEE 802.1AB Link Layer Discovery Protocol (LLDP) provides a standards-based method for network devices to discover each other and exchange information about their capabilities. An LLDP device advertises itself to adjacent (neighbor) devices by transmitting LLDP data packets on all ports on which outbound LLDP is enabled, and reading LLDP advertisements from neighbor devices on ports that are inbound LLDP-enabled. An LLDP enabled port receiving LLDP packets inbound from neighbor devices stores the packet data in a Neighbor database (MIB).

LLDP information is used by network management tools to create accurate physical network topologies by determining which devices are neighbors and through which ports they connect.

LLDP operates at layer 2 and requires an LLDP agent to be active on each network interface that will send and receive LLDP advertisements. LLDP advertisements can contain a variable number of TLV (type, length, value) information elements. Each TLV describes a single attribute of a device.

When an LLDP agent receives information from another device, it stores it locally in a special LLDP MIB (management information base). This information can then be queried by other devices via SNMP.

Support is provided for the following MIBs:

- Physical topology MIB (RFC 2922)
- Entity MIB version 2 (RFC 2737)
- Interfaces MIB (RFC 2863)

---

**NOTE:** LLDP information is only sent/received on Ethernet links. LLDP information is not collected from wireless devices connected to an AP. However, LLDP can function across a local mesh link and will show the AP on the other side of the link as a neighbor.

---

### LLDP agent

Select this option to enable the LLDP agent on port 1. Select **Configure TLVs** to customize TLV support.

#### Transmit

Enable this option to have the agent transmit LLDP information to its neighbors.

#### Receive

Enable this option to have the agent accept LLDP information from its neighbors.

### LLDP over local mesh

Enables support for LLDP on any active local mesh links. APs on the other side of a local mesh link will be shown as neighbors when this feature is active.

### LLDP settings

Use these options to define global LLDP settings.

#### Transmit interval

Sets the interval (in seconds) at which local LLDP information is updated and TLVs are sent to neighboring network devices.

#### Multiplier

The value of **Multiplier** is multiplied by the **Transmit interval** to define the length of **Time to live**.

#### Time to live

Indicates the length of time that neighbors will consider LLDP information sent by this agent to be valid. **Time to live** is automatically calculated by multiplying **Transmit interval** by **Multiplier**.

#### Port Description TLV content

Select the content to be included in and advertised as part of the port description TLV.

**Interface friendly name:** Use the friendly name for the interface (the name you see in the management tool). For example: LAN port, Internet port.

**Interface internal name:** Use the internal name for the interface. For example: eth0, eth1.

#### Generate dynamic system names

When enabled, this feature replaces the system name with a dynamically generated value which you can define.

## Access Point name

Specify how the dynamically generated name will be created. You can use regular text in combination with placeholders to create the name. Placeholders are automatically expanded each time the name is regenerated.

If the placeholders cause the generated name to exceed 32 characters, it is truncated.

## Placeholders

**%RN:** System name of the neighboring device to which the port is connected, obtained via the System Name TLV. Since this is an optional TLV, if it is not available, the Chassis ID TLV is used instead.

**%RP:** Port description of the port on the neighboring device to which the local port is connected, obtained via the Port Description TLV. Since this is an optional TLV, if it is not available, the Port ID TLV is used instead.

**%SN:** AP name suffix (if specified). Up to 16 characters can be appended to the name.

**%IP:** AP's IP address. An IP address can require up to 15 characters (nnn.nnn.nnn.nnn).

## Expanded Access Point name

Specify how the dynamically generated name will be created. You can use regular text in combination with placeholders to create the name. Placeholders are automatically expanded each time the name is regenerated.

If the placeholders cause the generated name to exceed 32 characters, it is truncated.

To create the system name, the items are concatenated using a hyphen as separator. For example:

systemname-portid-suffix

---

**NOTE:** Once AP names are dynamically changed by this feature, there is no way to return to the old AP names.

---

## TLV settings

To customize TLV settings, select **Configure TLVs** on the **Network > Discovery protocols** page.

TLV support - Port 1

**Basic TLVs** ?

**Mandatory TLVs**

Chassis ID: 00:24:a8:88:50:58  
Port ID: 00:24:a8:88:50:58  
Time To Live: 150

**Optional TLVs**

Port description: Port 1  
 System name: SG0072SW8T  
 System description: AP\_Autonomous,SG  
 System capabilities: WLAN Access Point  
Management address: 0.0.0.0

**802.3 TLVs** ?

MAC/PHY configuration/status

Cancel Save

## Basic TLVs

The AP supports all mandatory and optional TLVs (type, length, value) information elements that are part of the basic management set.

### Mandatory TLVs

The AP always sends these TLVs with the values as shown.

#### Chassis ID

(Type 1): The MAC address of the AP.

#### Port ID

(Type 2): The MAC address of the port on which the TLV will be transmitted.

#### Time to live

(Type 3): Defines the length of time that neighbors will consider LLDP information sent by this agent to be valid. Calculated by multiplying **Transmit interval** by the **Multiplier** (as defined on the **Discovery protocols** page).

### Optional TLVs

Select the optional TLVs that you want to send with the values as shown.

#### Port description

(Type 4): A description of the port.

#### System name

(Type 5): Administrative name assigned to the device from which the TLV was transmitted. By default this is the SNMP system name. If the **Generate dynamic system names** option is enabled, the system name is replaced by the dynamically generated name.

#### System description

(Type 6): Description of the system, comprised of the following information: operational mode, hardware type, hardware revision, and firmware version.

#### System capabilities

(Type 7): Indicates the primary function of the device. Set to:

##### WLAN access point

for APs

##### Router

for controllers.

#### Management IP address

(Type 8): Specify the IP address on which the agent will respond to management requests.

## 802.3 TLVs

The IEEE 802.3 organizationally specific TLV set is optional for all LLDP implementations. The AP supports a single optional TLV from the 802.3 definition.

### MAC/PHY configuration/status

This TLV provides the following information:

- Bit-rate and duplex capability
- Current duplex and bit-rating
- Whether these settings were the result of auto-negotiation during link initiation or manual override.

## DNS configuration

When the Bridge port is configured to obtain an IP address via PPPoE or DHCP:

The screenshot shows the DNS configuration window. On the left, under "DNS servers", there is a section for "Dynamically assigned DNS servers" with fields for Server 1, Server 2, and Server 3. Below this is a checkbox for "Override dynamically assigned DNS servers". When checked, there are input fields for Server 1 (containing "192.168.5.111"), Server 2, and Server 3. On the right, under "DNS advanced settings", there are three checkboxes: "DNS cache" (checked), "DNS switch on server failure" (unchecked), and "DNS switch over" (unchecked). A "Save" button is located at the bottom right.

When the Bridge port is configured to use a static IP address:

This screenshot shows the same DNS configuration window but with the "Override dynamically assigned DNS servers" checkbox checked. The "Dynamically assigned DNS servers" section is now empty. The "Server 1" field is active and contains a blank space, while "Server 2" and "Server 3" are also blank. The "DNS advanced settings" section remains the same as in the previous screenshot.

## DNS servers

### Dynamically assigned servers

Shows the DNS servers that are dynamically assigned to the controller when PPPoE or DHCP is used to obtain an IP address on the Internet port.

### Override dynamically assigned DNS servers

Enable this checkbox to use the DNS servers that you specify on this page to replace those that are assigned to the controller.

#### Server 1

Specify the IP address of the primary DNS server for the controller to use.

#### Server 2

Specify the IP address of the secondary DNS server for the controller to use.

#### Server 3

Specify the IP address of the tertiary DNS server for the controller to use.

## DNS advanced settings

### DNS cache

Enable this checkbox to activate the DNS cache. Once a host name is successfully resolved to an IP address by a remote DNS server, it is stored in the cache. This speeds up network performance, because the remote DNS server does not have to be queried for subsequent requests for this host.



An entry stays in the cache until one of the following is true:

- An error occurs when connecting to the remote host.
- The time to live (TTL) of the DNS request expires.
- The AP restarts.

### DNS switch on server failure

Controls how the AP switches between servers:

- When enabled, the AP switches servers if the current server replies with a DNS server failure message.
- When disabled, the AP switches servers if the current server does not reply to a DNS request.

### DNS switch over

Controls how the AP switches back to the primary server.

- When enabled, the AP switches back to the primary server once the primary server becomes available again.
- When disabled, the AP switches back to the primary server only when the secondary server becomes unavailable.

## Defining IP routes

All wireless traffic on the AP is bridged to the egress interface on the VSC with which it is associated. Therefore, IP routes cannot be applied to user traffic. However, IP routes can be used to ensure that the management traffic generated by the AP is sent to the correct destination. For example, if two VSCs are defined, each with authentication assigned to a different RADIUS server operating on a different subnet and VLAN, routing table entries may be required to ensure proper communication with the RADIUS servers.

## Configuring IP routes

To view and configure IP routes, select **Network > IP routes**.

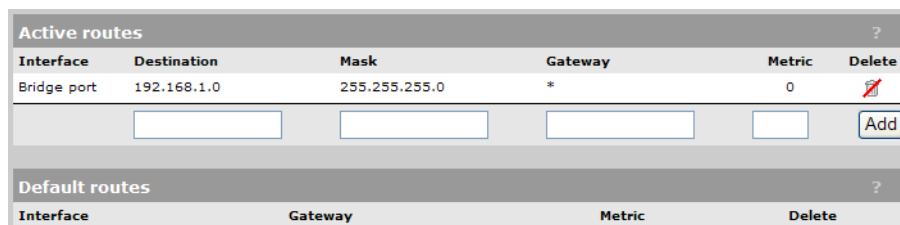

Active routes						?
Interface	Destination	Mask	Gateway	Metric	Delete	
Bridge port	192.168.1.0	255.255.255.0	*	0		
<input type="text"/>	<input type="text"/>	<input type="text"/>	<input type="text"/>	<input type="text"/>	<input type="text"/>	Add

Default routes				?
Interface	Gateway	Metric	Delete	

### Active routes

This table shows all active routes on the AP. You can add routes by specifying the appropriate parameters and then selecting **Add**.

The routing table is dynamic and is updated as needed. This means that during normal operation the AP adds routes to the table as required. You cannot delete these system routes.

The following information is shown for each active route:

- **Interface:** The port through which traffic is routed. When you add a route, the AP automatically determines the interface to be used based on the **Gateway** address.
- **Destination:** Traffic addressed to this IP address or subnet is routed.
- **Mask:** Number of bits in the destination address that are checked for a match.

- **Gateway:** IP address of the gateway to which the AP forwards routed traffic (known as the next hop).  
An asterisk is used by system routes to indicate a directly connected network.
- **Metric:** Priority of a route. If two routes exist for a destination address, the AP chooses the one with the lower metric.
- **Delete:** Select the garbage can icon to delete a route. If the icon has a red line through it, then the route cannot be deleted.

## Default routes

The **Default routes** table shows all default routes on the AP. Default routes are used when traffic does not match any route in the Active routes table. You can add routes by specifying the appropriate parameters and then selecting **Add**.

The routing table is dynamic and is updated as needed. If more than one default route exists, the first route in the table is used.

The following information is shown for each default route:

- **Interface:** The port through which traffic is routed. When you add a route, the AP automatically determines the interface to be used based on the **Gateway** address.
- **Gateway:** IP address of the gateway to which the AP forwards routed traffic (known as the next hop).  
An asterisk is used by system routes to indicate a directly connected network.
- **Metric:** Priority of a route. If two routes exist for a destination address, the AP chooses the one with the lower metric.
- **Delete:** Select the garbage can icon to delete a route. If the icon has a red line through it, then the route cannot be deleted.

## IP QoS

You configure IP quality of service (QoS) by creating IP QoS profiles that you can then associate with a VSC ("[Quality of service](#)" (page 71)) or with local mesh profiles ("[Quality of service](#)" (page 113)). You can configure up to 32 IP QoS profiles on the AP. You can associate up to 10 IP QoS profiles to a VSC.

## Configuring IP QoS profiles

To view and configure IP QoS profiles, select **Network > IP QoS**. Initially, no profiles are defined.

Name	Protocol	Start port	End port	Priority
<a href="#">SNMP</a>	6 (TCP)	161 (SNMP)	161	High
<a href="#">Web</a>	6 (TCP)	80 (http)	80	Low

Add New Profile...

To create an IP QoS profile, select **Add New Profile**.

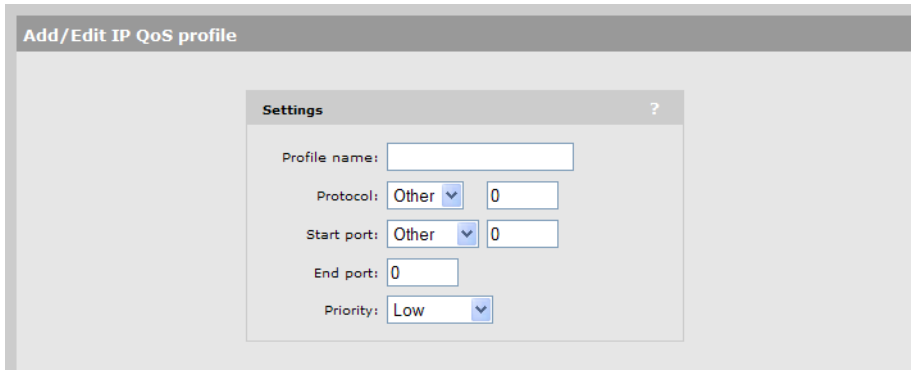

## Settings

- **Profile name:** Specify a unique name to identify the profile.
- **Protocol:** Specify an IP protocol to use to classify traffic by specifying its Internet Assigned Numbers Authority (IANA) protocol number. Protocol numbers are pre-defined for a number of common protocols. If the protocol you require does not appear in the list, select **Other** and specify the appropriate number manually. You can find IANA-assigned protocol numbers on the Internet.
- **Start port/ End port:** Optionally specify the first and last port numbers in the range of ports to which this IP QoS profile applies. To specify a single port, specify the same port number for both Start port and End port. Port numbers are pre-defined for a number of common protocols. If the protocol you require does not appear in the list, select **Other** and specify the appropriate number manually.

---

**NOTE:** To accept traffic on all ports for a specified protocol, set **Start port** to **Other** and **0**. Also set **End port** to **65535**.

---

- **Priority:** Select the priority level that will be assigned to traffic that meets the criteria specified in this IP QoS profile.

---

**NOTE:** It is strongly recommended that you reserve **Very high** priority for voice applications.

---

## Example

This example shows how to create two IP QoS profiles and associated them with a VSC. The two profiles are:

- **Voice:** Provides voice traffic with high priority.
- **Web:** Provides HTTP traffic with low priority.

## Create the profiles

1. Select **Network > IP QoS**, and then **Add New Profile**. The **IP QoS Profile** page opens.
2. Under **Profile name**, specify **Voice**.
3. Under **Protocol**, from the drop-down list select **TCP**.
4. Under **Start port**, from the drop-down list select **SIP**. **Start port** and **End port** are automatically populated with the correct value: **5060**.
5. Under **Priority**, from the drop-down list select **Very High**.

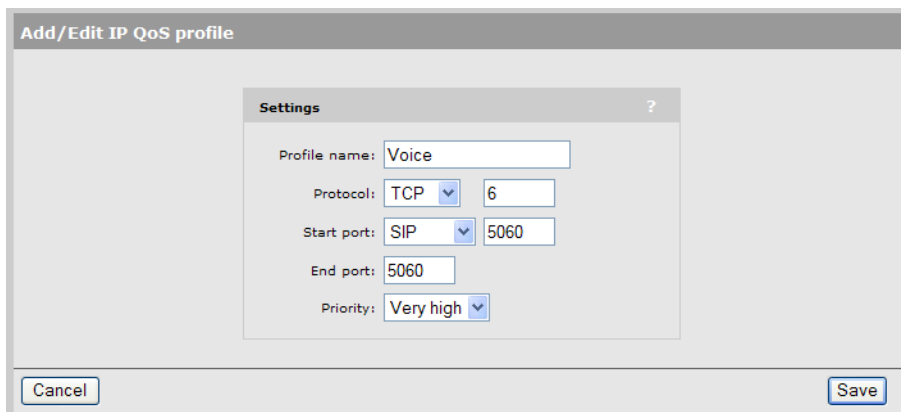

6. Select **Save**.

---

**NOTE:** You could also create another profile using the same parameters but for UDP to cope with any kind of SIP traffic.

---

7. On the **IP QoS Profile** page select **Add New Profile**.
8. Under **Profile name**, specify **Web**.
9. Under **Protocol**, from the drop-down list select **TCP**.
10. Under **Start port**, from the drop-down list select **http**. **Start port** and **End port** are automatically populated with the common HTTP port, **80**.
11. Under **Priority**, from the drop-down list select **Low**.

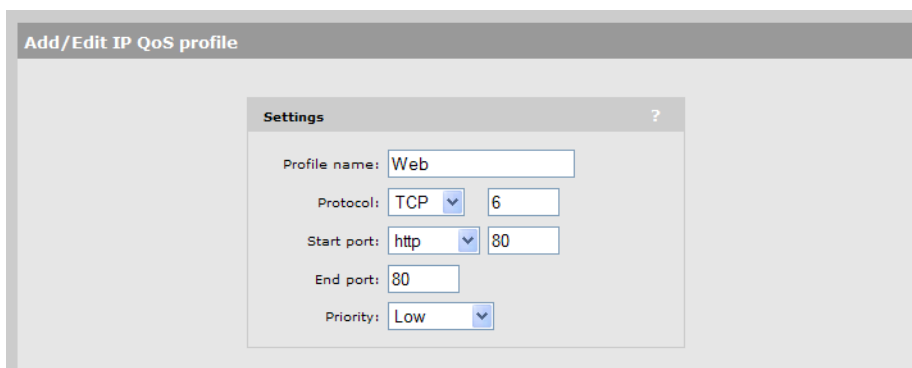

12. Select **Save**.

### Assign the profiles to a VSC

1. Select **VSC > Profiles**, and then select one of the VSC profiles in the **Name** column. Scroll down to the **Quality of service** section in the **Virtual AP** box.

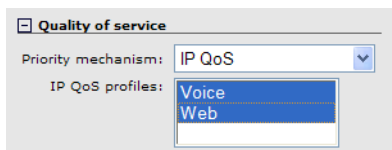

2. Under **Quality of service**, set **Priority mechanism** to **IP QoS**.
3. In **IP QoS profiles**, Ctrl-click each profile.
4. Select **Save**.

## Customizing DiffServ DSCP mappings

(These settings do not apply to IP QoS.)

You can create custom DSCP mappings that let you override the standard DSCP mappings that are defined by default when you enable DiffServ as the QoS priority mechanism for a VSC or for local mesh links. This enables you to customize how traffic is assigned to the QoS priority queues.

To view and configure DSCP mappings, select **Network > IP QoS**. Initially, no mappings are defined.



The screenshot shows a window titled "DSCP mappings" with a table containing columns for "DSCP tag", "Priority", and "Delete". Below the table, there is an empty text input field for the DSCP tag, a dropdown menu set to "Background", and an "Add" button.

**DSCP tag** DSCP codepoint value.

**Priority** Indicates the priority level assigned to traffic that matches the DSCP tag.

- **Background:** Assigns the traffic to queue 4 (Lowest priority).
- **Best effort:** Assigns the traffic to queue 3.
- **Video:** Assigns the traffic to queue 2.
- **Voice:** Assigns the traffic to queue 1 (Highest priority).

### To create a new mapping

Specify a value for **DSCP tag**, select a **Priority**, and then select **Add**.



The screenshot shows the "DSCP mappings" window with one entry in the table: DSCP tag "12" with priority "Background" and a delete icon. Below the table, the DSCP tag input field contains "55", the priority dropdown is set to "Best Effort", and the "Add" button is visible.

## 802.1X supplicant

The 802.1X supplicant can be used when the AP is connected to a secure switch port that requires 802.1X authentication. To configure the 802.1X supplicant, select **Network > 802.1X supplicant**.

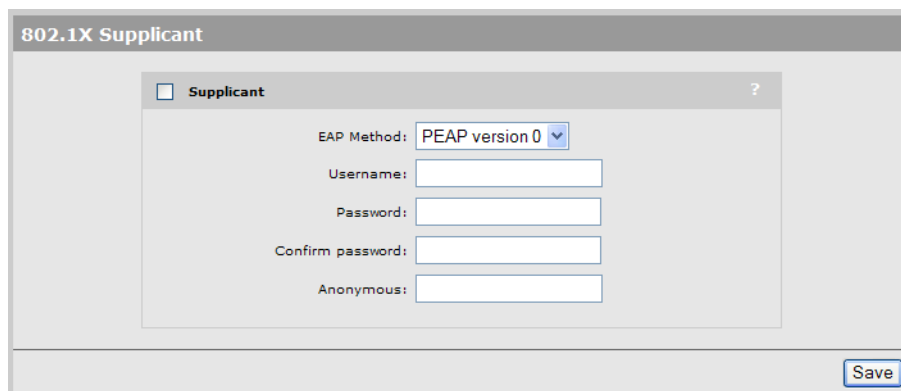

The screenshot shows the "802.1X Supplicant" configuration window. It features a checkbox labeled "Supplicant" which is checked. Below this, there are several fields: "EAP Method" set to "PEAP version 0", "Username", "Password", "Confirm password", and "Anonymous". A "Save" button is located at the bottom right.

### Important

- If this option is enabled and the AP is connected to a unsecured switch port, 802.1X is ignored.
- The AP always performs 802.1X authentication without VLAN tagging. The switch port is expected to be multi-homed, so that once authentication is successful, tagged and untagged traffic for any MAC addresses (including wireless clients) will be accepted by the switch.

- VLAN attributes received in the RADIUS access accept are not provided to other applications running on the AP.
- The AP sends the EAPOL start and waits for the Request Identity. On a time-out, the AP will perform a single retry. On a second time-out, the 802.1X supplicant will become idle. The switch is responsible for restarting the IEEE 802.1X authentication by sending an EAP Request Identity.

## EAP Method

Select the extensible authentication protocol method to use:

- **PEAP version 0:** Authentication occurs using MS-CHAP V2.
- **PEAP version 1:** Authentication occurs using EAP-GTC.
- **TTLS:** The Tunneled Transport Layer Security protocol requires that the switch first authenticate itself to the AP by sending a PKI certificate. The AP authenticates itself to the switch by supplying a username and password over the secure tunnel.

## Username

Username that the AP will use inside the TLS tunnel.

## Password / Confirm password

Password assigned to the AP.

## Anonymous

Name used outside the TLS tunnel by all three EAP methods. If this field is blank, then the value specified for **Username** is used instead.

---

# 4 Wireless configuration

## Wireless coverage

As a starting point for planning your network, you can assume that when operating at high power, an AP radio provides a wireless networking area (also called a wireless cell) of up to 300 feet (100 meters) in diameter. Before creating a permanent installation however, you should always perform a site survey (see [“Wireless neighborhood” \(page 50\)](#)) to determine the optimal settings and location for the AP.

---

**NOTE:** Supported wireless modes, operating channels, and power output vary according to the AP model, and are governed by the regulations of the country in which the AP is operating (called the regulatory domain). For a list of all operating modes, see [“Radio configuration” \(page 36\)](#). To set the regulatory domain, see [“Country” \(page 13\)](#).

---

## Factors limiting wireless coverage

Wireless coverage is affected by the factors discussed in this section.

### Radio power

More radio power means better signal quality and the ability to create bigger wireless cells. However, cell size should generally not exceed the range of transmission supported by wireless users. If it does, users will be able to receive signals from the AP but will not be able to reply, rendering the connection useless. Further, when more than one AP operates in an area, you must adjust wireless cell size to reduce interference between APs. An automatic power control feature is available to address this challenge. See [“Transmit power control” \(page 48\)](#).

### Antenna configuration

Antennas play a large role in determining the shape of the wireless cell and transmission distance. See the specifications for the antennas you use to determine how they affect wireless coverage.

### Interference

Interference is caused by other APs or devices that operate in the same frequency band as the AP and can substantially affect throughput. Advanced wireless configuration features are available to automatically eliminate this problem. See [“Radio configuration” \(page 36\)](#).

In addition, the several tools are available to diagnose interference problems as they occur.

- Select **Wireless > Overview** to view information about each connected wireless client.
- Select **Wireless > Neighborhood** to view a list of wireless radios operating nearby.
- Enable the **Severe interface detection/mitigation** feature on the Radio configuration page to automatically switch channels when interference is detected. See [“Severe interference detection/mitigation” \(page 46\)](#).

---

**△ CAUTION:** APs that operate in the 2.4 GHz band may experience interference from 2.4 GHz cordless phones and microwave ovens.

---

### Physical characteristics of the location

To maximize coverage of a wireless cell, wireless APs are best installed in an open area with as few obstructions as possible. Try to choose a location that is central to the area being served.

Radio waves cannot penetrate metal; they are reflected instead. A wireless AP can transmit through wood or plaster walls and closed windows; however, the steel reinforcing found in concrete walls and floors may block transmissions or reduce signal quality by creating reflections. This can make

it difficult or impossible for a single AP to serve users on different floors in a concrete building. Such installations require a separate wireless AP on each floor.

## Configuring overlapping wireless cells

Overlapping wireless cells occur when two or more APs are operating within transmission range of each other. This may be under your control, (for example, when you use several cells to cover a large location), or out of your control (for example, when your neighbors set up their own wireless networks). When APs are operating in the 2.4 GHz band, overlapping wireless cells can cause performance degradation due to insufficient channel separation.

## Performance degradation and channel separation

When two wireless cells operating on the same frequency overlap, throughput can be reduced in both cells. Reduced throughput occurs because a wireless user that is attempting to transmit data defers (delays) transmission if another station is transmitting. In a network with many users and much traffic, these delayed transmissions can severely affect performance, because wireless users may defer several times before the channel becomes available. If a wireless user is forced to delay transmission too many times, data can be lost.

Delays and lost transmissions can severely reduce throughput on a network. To view this information about your network, select **Status > Wireless**. For recommendations on using this information to diagnose wireless problems, see the online help for this page.

The following example shows two overlapping wireless cells operating on the same channel (frequency). Since both APs are within range of each other, the number of deferred transmissions can be large.

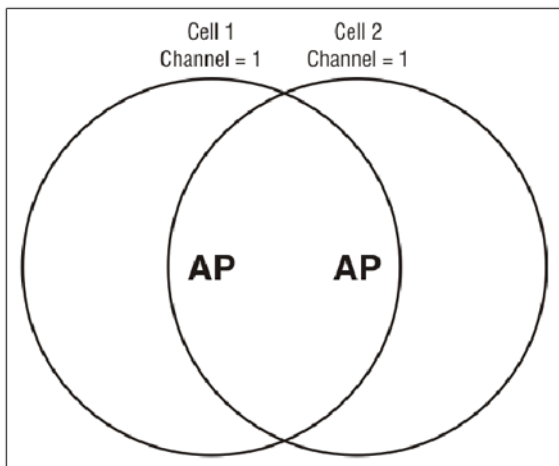

The solution to this problem is to configure the two AP to operate on different channels. Unfortunately, in the 2.4 GHz band, adjacent channels overlap. So even though APs are operating on different channels, interference can still occur. This is not an issue in the 5 GHz band, as all channels are non-overlapping.

## Selecting channels in the 2.4 GHz band

In the 2.4 GHz band, the center frequency of each channel is spaced 5 MHz apart (except for channel 14). Each 802.11 channel uses 20 MHz of bandwidth (10 MHz above and 10 MHz



below the center frequency), which means that adjacent channels overlap and interfere with each other as follows:

Channel	Center frequency	Overlaps channels	Channel	Center frequency	Overlaps channels
1	2412	2, 3	8	2447	6, 7, 9, 10
2	2417	1, 3, 4	9	2452	7, 8, 10, 11
3	2422	1, 2, 4, 5	10	2457	8, 9, 11, 12
4	2427	2, 3, 5, 6	11	2462	9, 10, 12, 13
5	2432	3, 4, 6, 7	12	2467	10, 11, 13
6	2437	4, 5, 7, 8	13	2472	11, 12
7	2442	5, 6, 8, 9	14	2484	

To avoid interference, APs in the same area must use channels that are separated by at least 25 MHz (5 channels). For example, if an AP is operating on channel 3, and a second AP is operating on channel 7, interference occurs on channel 5. For optimal performance, the second AP should be moved to channel 8 (or higher).

With the proliferation of wireless networks, it is possible that the wireless cells of APs outside your control overlap your intended area of coverage. To choose the best operating frequency, select **Wireless > Neighborhood** to view a list of all APs that are operating nearby and their operating frequencies.

The number of channels available for use in a particular country are determined by the regulations defined by the local governing body and are automatically configured by the AP based on the Country setting you define. (See [“Country” \(page 13\)](#)). This means that the number of non-overlapping channels available to you varies by geographical location.

The following table shows the number of channels that are available in North America, Japan, and Europe.

Region	Available channels
North America	1 to 11
Japan	1 to 14
Europe	1 to 13

Since the minimum recommended separation between overlapping channels is 25 MHz (five channels) the recommended maximum number of overlapping cells you can have in most regions is three. The following table gives examples relevant to North America, Japan, and Europe (applies to 22 MHz channels in the 2.4 GHz band).

North America	Japan	Europe
cell 1 on channel 1	cell 1 on channel 1	cell 1 on channel 1
cell 2 on channel 6	cell 2 on channel 7	cell 2 on channel 7
cell 3 on channel 11	cell 3 on channel 14	cell 3 on channel 13

In North America you can create an installation as shown in the following figure.

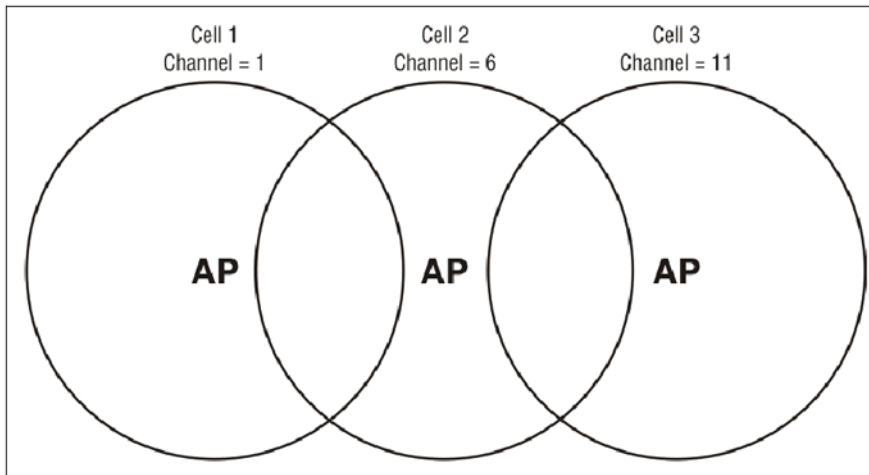

*Reducing transmission delays by using different operating frequencies in North America.*

Alternatively, you can stagger cells to reduce overlap and increase channel separation, as shown in the following figure.

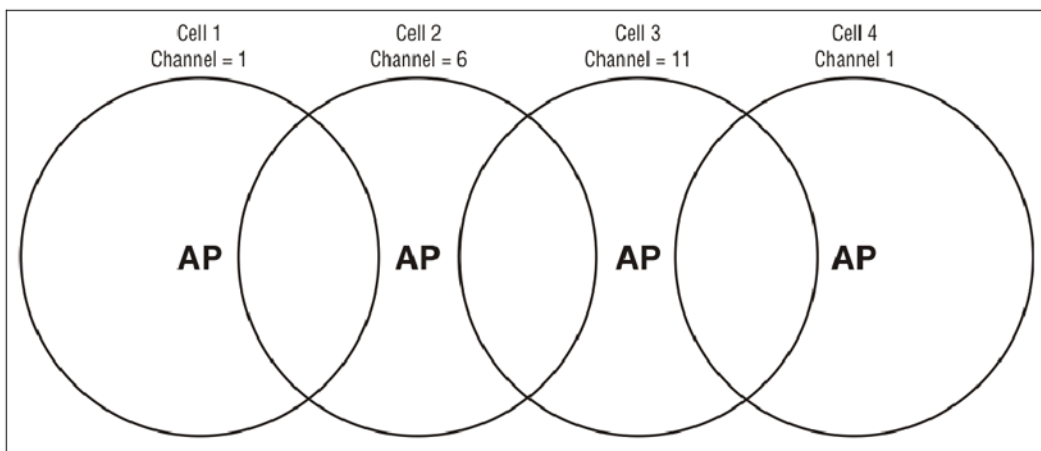

*Using only three frequencies across multiple cells in North America.*

This strategy can be expanded to cover an even larger area using three channels, as shown in the following figure.

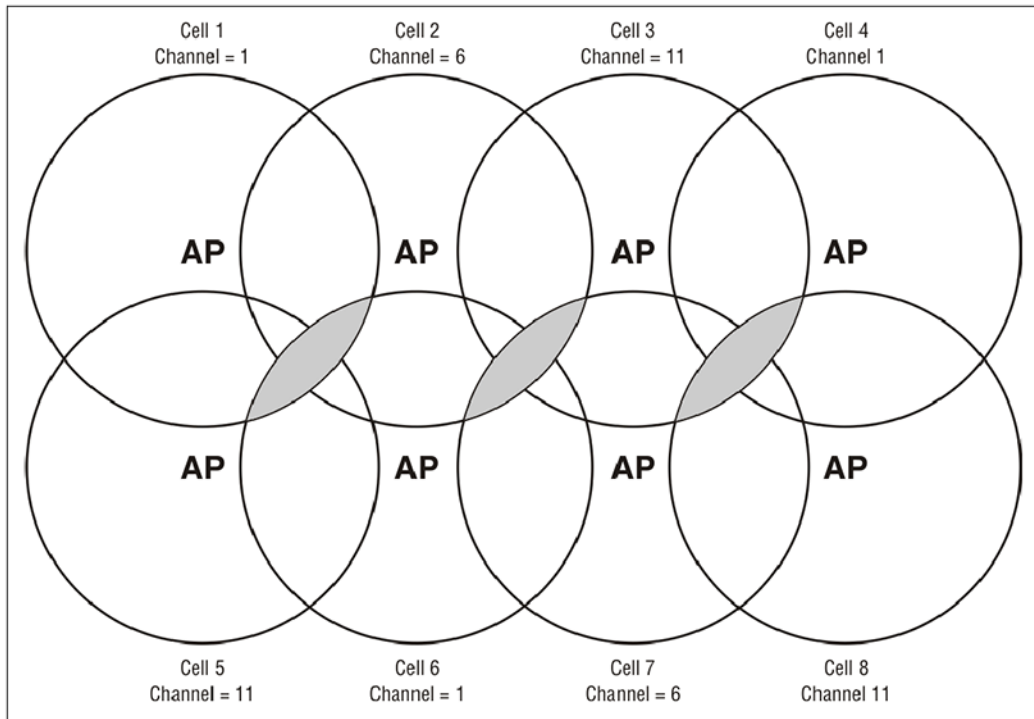

Using three frequencies to cover a large area in North America. Gray areas indicate overlap between two cells that use the same frequency.

### Distance between APs

In environments where the number of wireless frequencies is limited, it can be beneficial to adjust the receiver sensitivity of the AP. To make the adjustment, select **Wireless > Radio** and set the **Distance between access points** option.

For most installations, **Distance between access points** should be set to **Large**. However, if you are installing several wireless APs and the channels available to you do not provide enough separation, reducing receiver sensitivity can help you to reduce the amount of crosstalk between wireless APs.

Another benefit to using reduced settings is that it improves roaming performance. Wireless users switch between APs more frequently.

### Automatic transmit power control

The automatic power control feature enables the AP to dynamically adjust its transmission power to avoid causing interference with neighboring HP APs. For information see [“Transmit power control”](#) (page 48).

### Supporting 802.11a and legacy wireless clients

The 802.11n standard is very similar to the 802.11g standard, in that both provide mechanisms to support older wireless standards. In the case of 802.11g, protection mechanisms were created to allow 802.11b and 802.11g wireless devices to co-exist on the same frequencies. The data rates of 802.11g (6, 9, 12, 18, 24, 36, 48 and 54 Mbps) are transmitted using Orthogonal Frequency Division Multiplexing (OFDM) modulation, while the data rates of 802.11b are transmitted using Direct Sequence Spread Spectrum (DSSS) modulation. Since older 802.11b-only clients cannot detect OFDM transmissions, 802.11g clients must “protect” their transmissions by first sending a frame using DSSS modulation. This frame – usually a CTS-to-self or RTS/CTS exchange – alerts 802.11b clients to not attempt to transmit for a specified period of time.

If protection is not used, 802.11b clients may transmit a frame while an 802.11g frame is already being sent. This leads to a collision and both devices need to re-transmit. If there are enough

devices in the network, the collision rate will grow exponentially and prevent any useful throughput from the wireless network.

802.11n clients face the same problem as described above – legacy 802.11b clients cannot detect the High Throughput (HT) rates that 802.11n uses. So to avoid causing excessive collisions, 802.11n clients must use the same protection mechanisms when a legacy client is present. Even the most efficient protection mechanism (CTS-to-self) causes a substantial decline in throughput; performance can decline by as much as 50 percent. For this reason, the protection behavior of the MSM430, MSM460, MSM466, and MSM466-R can be configured (see [“Tx protection” \(page 46\)](#)) to allow network administrators greater flexibility over their deployments.

---

**NOTE:** 802.11n clients can only achieve maximum throughput when legacy clients are not present on the same radio. You can use the **Allow 802.11n clients only** setting to segregate 802.11n traffic to ensure that 802.11n clients do not experience performance degradation by sharing a wireless network with legacy (slower) client stations.

---

## Radio configuration

To define configuration settings for a radio, select **Wireless > Radio(s)**. This opens the Radio(s) configuration page. The contents of this page varies depending on the product. The following screen shows the Radio(s) configuration page for the MSM460. Configuration settings are the same on other products.

**Radios configuration**

**Radio 1** ?

Regulatory domain: **UNITED STATES**

Operating mode: **Access point only** ▼

Wireless mode: **802.11n/a (5 GHz)** ▼

Channel width: **Auto 20/40 MHz** ▼

Channel: **Automatic** ▼

Interval: **Time of Day** ▼

Time of day: **01** hh **00** mm

Currently: **Channel 1, 2.412GHz**

Automatic channel exclusion list: **Channel 1, 2.412GHz**  
**Channel 2, 2.417GHz**  
**Channel 3, 2.422GHz**

Max clients: **255**

---

**Advanced wireless settings**

Client restriction: **Disabled** ▼

Collect statistics for wireless clients

Tx beamforming

RTS threshold:  bytes

Spectralink VIEW

Severe interference detection/mitigation

Tx protection: **CTS-to-self** ▼

Guard interval: **Short** ▼

Distance between APs: **Large** ▼

Beacon interval: **100** time units (TU)

Multicast Tx rate: **6.0 Mb/s** ▼

Traffic shaping: **Disabled** ▼

**Transmit power control**

Maximum output power: **27 dBm (EIRP)**

Use maximum power

Set power to **7** dBm  
which is **1** % of max power

Automatic power control

Interval: **1 hour** ▼

---

**Neighborhood scanning**

Scan ratio: **0.5** %

Dwell time: **20** ms

Scanning mode: **Passive** ▼

Bands to scan: **All bands** ▼

Channels to scan: **All channels** ▼

Neighbor detection time: **5477 s**

**Radio 2** ?

Regulatory domain: **UNITED STATES**

Operating mode: **Monitor** ▼

Wireless mode: **802.11n/b/g (2.4 GHz)** ▼

Channel width: **Auto 20/40 MHz** ▼

Channel extension: **Above the beacon (+1)** ▼

Channel: **Automatic** ▼

---

**Neighborhood scanning**

Dwell time: **20** ms

Scanning mode: **Passive** ▼

Channels to scan: **All channels** ▼

## Radio configuration parameters

This section provides definitions for all configuration parameters that are present on all products.

### Regulatory domain

Indicates the geographical region in which the AP is operating. To set the regulatory domain, see "Country" (page 13).

## Operating mode

Select the operating mode for the radio. Available options are:

- **Access point and Local mesh:** Standard operating mode provides support for all wireless functions. The total available bandwidth on the radio is shared between all local mesh links and wireless users. This can result in reduced throughput if lots of traffic is being sent by both wireless users and the local mesh links. You can use the QoS feature to prioritize traffic.
- **Access point only:** Only provides AP functionality, local mesh links cannot be created.
- **Local mesh only:** Only provides local mesh functionality. Wireless client stations cannot connect.
- **Monitor:** Disables AP and local mesh functions. Use this option for continuous scanning across all channels in all wireless modes. See the results of the scans by selecting **Wireless > Neighborhood**. This mode also enables 802.11 traffic to be traced using the **Tools > Network trace** feature.
- **Sensor:** Enables RF sensor functionality on the radio. HP APs are smart APs, and do not forward broadcast packets when no client stations are connected. Therefore, the RF sensor function will not be able to detect these APs unless they have at least one connected wireless client station. This feature requires that the appropriate license is installed on the AP. See ???.

The following table shows the operating modes supported for each product.

Product	Access point and Local mesh	Access point only	Local mesh only	Monitor	Sensor
MSM410	✓	✓	✓	✓	×
MSM422	✓	✓	✓	✓	×
MSM430	✓	✓	✓	✓	×
MSM460	✓	✓	✓	✓	×
MSM466 MSM466-R	✓	✓	✓	✓	×
HP 560	✓	✓	✓	✓	×

The following table shows all radio parameters that are configurable for each operating mode.

Parameter	Access point and Local mesh	Access point only	Local mesh only	Monitor	Sensor
"Regulatory domain" (page 37)	✓	✓	✓	✓	✓
"Wireless mode" (page 39)	✓	✓	✓	✓	×
"Channel width" (page 41)	✓	✓	✓	✓	×
"Channel extension" (page 41)	✓	✓	✓	✓	×
"Channel" (page 41)	✓	✓	✓	✓	×
"Interval" (page 43)	✓	✓	✓	×	×
"Time of day" (page 43)	✓	✓	✓	×	×

Parameter	Access point and Local mesh	Access point only	Local mesh only	Monitor	Sensor
"Automatic channel exclusion list" (page 43)	✓	✓	✓	×	×
"Antenna selection" (page 44)	✓	✓	✓	×	✓
"Antenna gain" (page 44)	✓	✓	✓	×	×
"Max clients" (page 44)	✓	✓	✓	×	×
"Client restriction" (page 45)	✓	✓	✓	✓	✓
"Collect statistics for wireless clients" (page 45)	✓	✓	✓	×	×
"Tx beamforming" (page 45)	✓	✓	✓	×	×
"RTS threshold" (page 45)	✓	✓	✓	×	×
"Spectralink VIEW" (page 46)	✓	✓	✓	×	×
"Severe interference detection/mitigation" (page 46)	✓	✓	✓	×	×
"Tx protection" (page 46)	✓	✓	✓	×	×
"Guard interval" (page 46)	✓	✓	✓	×	×
"Maximum range (ack timeout)" (page 47)	✓	×	✓	×	×
"Distance between APs" (page 47)	✓	✓	✓	×	×
"Beacon interval" (page 47)	✓	✓	✓	×	×
"Multicast Tx rate" (page 47)	✓	✓	✓	×	×
"Transmit power control" (page 48)	✓	✓	✓	×	×

Certain parameters are not supported on all radios. Refer to the parameter descriptions that follow for details.

## Wireless mode

Supported wireless modes are determined by the regulations of the country in which the AP is operating, and are controlled by the country setting on the AP. To configure the country setting, see "Country" (page 13).

### 802.11ac/n/a (5 GHz)

<b>Supported on</b>	Radio 1 on: HP 560
<b>Frequency band</b>	5 GHz
<b>Data rates</b>	<b>For 802.11ac clients:</b> Up to 1300 Mbps. <b>For 802.11n clients:</b> Up to 450 Mbps. <b>For 802.11a clients:</b> Up to 54 Mbps.

When operating in this mode, the AP allows 802.11ac, 802.11n, and 802.11a clients to associate. The AP will dynamically adjust channel width and data rates to individually accommodate the capabilities of each associated wireless client.

### 802.11n/a (5 GHz)

<b>Supported on</b>	MSM410, MSM466, MSM466-R Radio 1 on: MSM422, MSM430, MSM460, and HP 560 (not supported in Monitor mode on the HP 560)
<b>Frequency band</b>	5 GHz
<b>Data rates</b>	<b>For 802.11n clients:</b> Up to 450 Mbps on the MSM466, MSM466-R, MSM460, and up to 300 Mbps on the MSM410, MSM422, and MSM430. <b>For 802.11a clients:</b> Up to 54 Mbps.

When operating in this mode, the AP allows both 802.11n and legacy 802.11a clients to associate. The AP advertises protection in the beacon when legacy clients are associated or operating on the same channel. This alerts associated 802.11n clients to use protection when transmitting. The AP also uses protection when necessary when sending 802.11n data. The type of protection is configurable by setting the **Tx protection** parameter .

### 802.11a (5 GHz)

<b>Supported on</b>	MSM410, MSM422, MSM466 Radio 1 on: MSM430, MSM460 (not supported in Monitor mode)
<b>Frequency band</b>	5 GHz
<b>Data rates</b>	Up to 54 Mbps.

This is a legacy mode that can be used to support older wireless client stations.

### 802.11n/b/g (2.4 GHz)

<b>Supported on</b>	MSM410, MSM422 Radio 2 on: MSM430, MSM460, MSM466, MSM466-R, HP 560.
<b>Frequency band</b>	2.4 GHz
<b>Data rates</b>	<b>For 802.11n clients:</b> Up to 130 Mbps on the MSM410, MSM422, MSM430. (Up to 300 Mbps when using a 40 MHz channel width, which is not recommended in the 2.4 GHz frequency band.) Up to 216.7 Mbps on the MSM460, MSM466, MSM466-R, HP 560. <b>For 802.11g clients:</b> Up to 54 Mbps. <b>For 802.11b clients:</b> Up to 11 Mbps.

When operating in this mode, the AP allows both 802.11n and legacy 802.11b/g clients to associate. The AP advertises protection in the beacon when legacy clients are associated or operating on the same channel. This alerts associated 802.11n clients to use protection when transmitting. The AP also uses protection when necessary when sending 802.11n data. The type of protection is configurable by setting the **Tx protection** parameter .



## 802.11b/g (2.4 GHz)

<b>Supported on</b>	MSM410, MSM422 Radio 2 on: MSM430, MSM460, MSM466, MSM466-R, HP 560
<b>Frequency band</b>	2.4 GHz
<b>Data rates</b>	<b>For 802.11g clients:</b> Up to 54 Mbps. <b>For 802.11b clients:</b> Up to 11 Mbps.

This is a legacy mode that can be used to support older wireless client stations.

### Channel width

*Supported on: MSM410, MSM422 (radio 1), MSM430, MSM460, MSM466, MSM466-R, HP 560.*

*Not available in Monitor or Sensor modes.*

802.11n allows for the use of the standard channel width of 20 MHz, or a double width of 40 MHz. The double width is achieved by using two adjacent channels to send data simultaneously. This results in double the available bandwidth leading to much higher throughput.

Select the **Channel width** from one of the following options:

- **20 MHz:** Uses the standard channel width of 20 MHz. Recommended when the AP is operating in the 2.4 GHz band and multiple networks must co-exist in the same location.
- **Auto 20/40 MHz:** The AP will advertise 40 MHz support to clients, but will use 20 MHz for each client that does not support 40 MHz.
- **Auto 20/40/80 MHz:** (Only supported when **Wireless mode** is set to 802.11ac/n/a on the HP 560.) The AP automatically adjusts channel width to support clients that are using 20, 40, or 80 MHz wide channels.

---

**NOTE:** When operating in the 2.4 GHz band, the MSM430, MSM460, MSM466, and MSM466-R will automatically switch to using a 20 MHz channel width if a legacy 802.11b/g client or AP is detected on the primary or secondary channel. When the legacy device is no longer present, the AP will revert back to using a 40 MHz channel width.

On the HP 517, when **Wireless mode** is set to **802.11n/b/g**, **Channel width** is automatically set to **20 MHz** and cannot be changed.

---

### Channel extension

*Supported on: MSM410, MSM422 (radio 1), MSM430 (radio 2), MSM460 (radio 2), MSM466 (radio 2), MSM466-R (radio 2), HP 560 (radio 2).*

*Not available in Sensor mode.*

This setting only appears when **Wireless mode** is set to **802.11n/b/g** and **Channel width** is set to **Auto 20/40 MHz**.

This setting determines where the second 20 MHz channel is located.

- **Above the beacon (+1):** The secondary channel is located on a channel above the currently selected channel.
- **Below the beacon (-1):** The secondary channel is located on a channel below the currently selected channel.

### Channel

Select channel (frequency) for wireless services. The channels that are available are determined by the radio installed in the AP and the regulations that apply in your country.

## Automatic channel selection

Use the **Automatic** option to have the AP select the best available channel. Control how often the channel selection is re-evaluated by setting the **Interval** parameter. If the **Interval** parameter is set to any value other than **Time of day**, and a wireless client is associated with the radio, automatic channel selection is delayed. The AP will retry at one minute intervals until the radio is unused by wireless clients.

### NOTE:

- **On the MSM430, MSM460, MSM466, MSM466-R, and HP 560:** Scanning is continuously performed on all channels in the currently selected **Operating mode**, even though the channel is only re-evaluated each time the **Interval** expires. (If **Interval** is set to **Disabled**, continuous scanning is not performed.) Continuous scanning can cause interruptions to voice calls. On dual-radio APs, you can avoid interruptions by setting one radio to operate in **Monitor** mode. For example, if radio 1 is set to **Automatic** and radio 2 is in **Monitor** mode, scanning occurs on radio 2 and interruptions on radio 1 do not occur.
- **On the MSM410, MSM422:** Scanning during the channel selection process can cause interruptions to voice calls each time the Interval expires. Therefore, HP does not recommend configuring a short **Interval**.

△ **CAUTION:** When using the **Automatic** option with an external antenna in the 2.4 GHz band, all channels must be set to the lowest acceptable value for your regulatory domain. See [“Transmit power control”](#) (page 48).

## Manual channel selection

If setting the channel manually, for optimal performance when operating in 2.4 GHz modes, select a channel that differs from other wireless APs operating in neighboring cells by at least 25 MHz. For example, if another AP is operating on channel 1, set the AP to channel 6 or higher.

See [“Wireless neighborhood”](#) (page 50) to view a list of APs currently operating in your area. For detailed information on selecting channels when operating at 2.4 GHz, see [“Configuring overlapping wireless cells”](#) (page 32).

When operating in 802.11a or 802.11n (5 GHz) modes, channels do not interfere with each other, enabling APs to operate on two adjacent channels without interference.

HP APs support Dynamic Frequency Selection (802.11h) and Transmit Power Control (802.11d) for 802.11a operation in European countries. These options are automatically enabled as required. Channels used by dynamic frequency selection (DFS) for radar avoidance, are identified with an asterisk “\*”.

- **On the MSM410, MSM422 (radio 1), MSM430, MSM460, MSM466, MSM466-R, HP 560:** When **Wireless mode** is **802.11n/a** and **Channel width** is **Auto 20/40 MHz**, the channel numbers in the **Channel** list include either a **(1)** or **(-1)** to their right. A **(1)** indicates that the 40 MHz channel is formed from the indicated channel plus the next channel. A **(-1)** indicates that the 40 MHz channel is formed from the indicated channel plus the previous channel.

With a 40 MHz Channel width in the 5 GHz band, channel selection and usage is as follows for the first four channels:

Channel selected	Channels used
36(1)	36+40
40(-1)	40+36
44(1)	44+48
48(-1)	48+44

**NOTE:** The channel selected is the primary channel and the channel above or below it becomes the secondary channel. The AP beacon is transmitted only on the primary channel and all legacy client traffic is carried on the primary channel.

- **On the MSM410, MSM422 (radio 1):** When **Wireless mode** is **802.11n/b/g**, and **Channel width** is **Auto 20/40 MHz**, the **Channel extension** parameter value affects which channels are shown in the Channel list. Although HP recommends that you use the 5 GHz band for all 802.11n activity, if you insist upon using 802.11n and a 40 MHz **Channel width** in the crowded 2.4 GHz band, it is best to select channels as follows, according to the number of 2.4 GHz channels available in your region.

Available 2.4 GHz channels	Channel width	Recommended non-overlapping channels
1 to 13	20 MHz	1, 7, 13
1 to 13	40 MHz	1, 13 (If both are used, there will be some performance degradation.)
1 to 11	20 MHz	1, 6, 11
1 to 11	40 MHz	1, 11 (If both are used, there will be some performance degradation.)

## Interval

*Not available in Monitor or Sensor modes, or when the system wide auto-channel feature is enabled.*

When the **Automatic** option is selected for **Channel**, this parameter determines how often the AP re-evaluates the channel setting. Select **Time of day** to have the channel setting re-evaluated at a specific time of day.

- Select **Time of day** to have the channel setting re-evaluated at a specific time of day. Note that to prevent all APs from re-evaluating their channel at the same time, a random delay between 0 and 2 hours is added to the time of day for each AP. If the **Interval** parameter is set to any value other than **Time of day**, and a wireless client is associated with the radio, automatic channel selection is delayed. The AP will retry at one minute intervals until the radio is unused by wireless clients.
- Select **a time interval** in hours to define how often the channel setting is re-evaluated. If a wireless client is associated with the radio when the interval occurs, automatic channel selection is delayed (at one minute intervals) until the radio is unused by wireless clients. Background scanning is not supported when you select this option.
- Select **Disabled** to have the scan performed once when you select **Save**, and then only when the AP is restarted. This also prevents continuous scanning from being performed on the MSM410, and MSM422.

## Time of day

*Not available in Monitor or Sensor modes, or when the system wide auto-channel feature is enabled.*

When the **Time of day** option is selected for **Interval**, this parameter determines the time of day that the AP re-evaluates the channel setting.

To prevent APs from re-evaluating their channel at the same time, a random delay between 0 and 2 hours is added to the time of day for each AP. For example, if 1AM is selected, the channel will be re-evaluated between 1AM and 3AM.

## Automatic channel exclusion list

*Not available in Monitor or Sensor modes, or when the system wide auto-channel feature is enabled.*

Used when **Automatic** is selected under **Channel**, this parameter determines the channels that are not available for automatic selection. To select more than one channel, hold down **Ctrl** as you select the channel names.

On the HP 560, channel 144 is excluded by default.

## Antenna selection

*Supported on: MSM422*

*Not available in Monitor or Sensor modes.*

Select the antenna(s) to use for each radio. Antenna support varies on each AP. For a list of supported external antennas, see [“Connecting external antennas”](#) (page 131).

In most APs, antenna diversity is supported. Diversity provides improved signal quality by using multiple antennas on the same radio.

---

### NOTE:

- When using an external antenna, it is your responsibility to make sure that the radio does not exceed the transmit power level for the country of use. See [“Transmit power control”](#) (page 48).
- When creating a point-to-point local mesh link, HP recommends that you use an external directional antenna.

---

## MSM422

Select either **Internal** or **External** according to the following guidelines:

### Radio 1

- Radio 1 features three internal antennas in the lower flap supporting 802.11n/a/b/g. Each antenna has a corresponding connector (A, B, C) for the installation of an optional external antenna.
- Radio 1 supports diversity on its internal and external antennas. In 802.11n modes, a special form of diversity, called MIMO, is used.

MIMO uses spatial multiplexing to transport two or more data streams simultaneously on the same channel to increase throughput. For example, under most conditions, multiplexing two streams can result in double the throughput of a single stream.

MIMO mode 3x3 is automatically used, which means that three antennas are used to transmit and three antennas are used to receive.

- For point-to-point local mesh links on Radio 1, install two directional antennas on connectors A and B. Installing a third directional antenna on connector C will increase performance only when receiving.

### Radio 2

- Radio 2 features two internal antennas in the upper flap supporting 802.11a/b/g. These antennas have a single connector (D) for the installation of an optional external antenna.
- Radio 2 provides support for diversity only on its two internal antennas. Diversity is not supported when using an external antenna.

## Antenna gain

*Supported on: MSM466, MSM466-R.*

*Not available in Monitor or Sensor modes.*

For optimum performance, this parameter must be set to the gain of the antenna.

## Max clients

*Not available in Monitor or Sensor modes.*

Specify the maximum number of wireless client stations that can be supported on this radio across all VSCs.

## Advanced wireless settings

### Client restriction

Only available when **Wireless mode** supports 802.11ac or 802.11n.

Use this option to restrict access to the wireless network to specific types of wireless clients.

- **802.11n only:** Only wireless clients supporting 802.11n can connect. This prevents 802.11a/b/g client stations from accessing the wireless network.
- **802.11ac only:** Only wireless clients supporting 802.11ac can connect. (HP 560)
- **802.11ac or 802.11n only:** Only wireless clients supporting 802.11ac or 802.11n can connect. (HP 560)

### Collect statistics for wireless clients

Not available in Monitor or Sensor modes.

When this option is enabled, the AP collects statistics for connected wireless client stations. The statistical information can be retrieved via SNMP from the following MIBs:

MIB	Table
COLUBRIS-DEVICE-WIRELESS-MIB.my(controlled mode)	coDeviceWirelessDetectedStationTable
COLUBRIS-IEEE802DOT11.my(autonomous mode)	coDot11DetectedStationTable

### Tx beamforming

Supported on: MSM430, MSM460, MSM466, MSM466-R, HP 560 (radio 2).

Not available in Monitor or Sensor modes.

Tx beamforming can be used to help increase throughput by improving the quality of the signal sent to wireless clients

When this option is enabled, APs use beamforming techniques to optimize the signal strength for each individual wireless client station. Beamforming works by changing the characteristics of the transmitter to create a focused beam that can be more optimally received by a wireless station.

HP APs support the following two explicit beamforming techniques:

- Non-compressed beamforming, in which the client station calculates and sends the steering matrix to the AP.
- Compressed beamforming, in which the client station sends a compressed steering matrix to the AP.

Radio calibration is not required to use either of these two methods.

---

**NOTE:** Beamforming only works with wireless clients that are configured to support it.

---

### RTS threshold

Not available in Monitor or Sensor modes.

Use this parameter to control collisions on the link that can reduce throughput. If the **Status > Wireless** page shows increasing values for **Tx multiple retry frames** or **Tx single retry frames**, adjust this value until the errors clear. Start with a value of 1024 and decrease to 512 until errors are reduced or eliminated. Note that using a small value for **RTS threshold** can affect throughput. Range: 128 to 1540.

If a packet is larger than the threshold, the AP holds the packet and issues a request to send (RTS) message to the client station. The AP sends the packet only when the client station replies with a clear to send (CTS) message. Packets smaller than the threshold are transmitted without this handshake.

## Spectralink VIEW

*Supported on: MSM410, MSM422, MSM430, MSM460, MSM466, MSM466-R, HP 560.*

*Not available in Monitor or Sensor modes.*

Provides support for Spectralink phones using Spectralink Voice Interoperability for Enterprise Wireless (VIEW) extensions.

## Severe interference detection/mitigation

*Supported on: MSM410, MSM430, MSM460, MSM466, MSM466-R, HP 560.*

*Not available in Monitor or Sensor modes.*

When an AP detects severe degradation in the channel quality of the current operating channel on a radio (that persists for tens of seconds), the AP does an intensive spectrum analysis scan to identify the type of interference (only on the MSM430, MSM460, and MSM466/466-R). The AP then chooses the best channel using the same methods as when auto-channel is enabled. (The AP may decide not to switch to a different channel. For example, if the RF interference source affects all channels in the band.)

After switching to an alternative channel, the AP continues to monitor the channel quality of the non-operating channels. Eventually, it is expected that the interference will go away. (Most interference sources are temporary.) The AP then decides whether it should switch back to the original channel or to continue operating on the alternate channel.

## Tx protection

*Supported on: MSM410, MSM430, MSM460, MSM466, MSM466-R, HP 560.*

*Not available in Monitor or Sensor modes.*

When an AP is operating in an 802.11n mode, and legacy (a/b/g) traffic is present on the same channel as 802.11n traffic, this feature can be used to ensure maximum 802.11n throughput.

The following options are available:

- **CTS-to-self:** 802.11n transmissions are protected by sending a Clear To Send (CTS) frame that blocks other wireless clients from accessing the wireless network.
- **RTS/CTS:** 802.11n transmissions are protected by sending a Request To Send (RTS) frame followed by a CTS frame. This is a more robust, but slower, solution than CTS-to-self. However, this method resolves the hidden station problem (where certain legacy stations may not see only a CTS frame).
- **No MAC protection:** This setting gives the best performance for 802.11n clients in the presence of 802.11g or 802.11a legacy clients or APs. No protection frames (CTS-to-self or RTS/CTS) are sent at the MAC layer by the AP. PHY-based protection remains active, which alerts legacy clients to stay off the air while the AP is transmitting data to 802.11n clients. This method of protection is supported by most 802.11g or 802.11a clients, but is not supported for 802.11b-only clients and should not be used if such clients are expected on the network.

## Guard interval

*Supported on: MSM410, MSM422 (radio 1), MSM430, MSM460, MSM466, MSM466-R, HP 560.*

*Not available in Monitor or Sensor modes.*

This parameter is only configurable when **Wireless mode** is set to support an 802.11n option.

On the MSM410 and MSM422, **Guard interval** is automatically set to **Long** when **Channel width** is set to **20 MHz**.

To enhance performance in 802.11n modes, the guard interval can be reduced from its default of 800 nanoseconds to 400.

The guard interval is the intersymbol time period that is used to prevent symbol interference when multiple data streams are used (MIMO). However, symbol interference reduces the effective SNR of the link, so reducing the guard interval may not improve performance under all conditions.

The following settings are available:

- **Short:** Sets the guard interval to 400 nanoseconds which can provide improved throughput (up to 10%) in some environments. The AP remains compatible with clients that only support a long guard interval. Use this setting when **Channel width** is set to **Auto 20/40 MHz** to get the best throughput.
- **Long:** Sets the guard interval to the standard of 800 nanoseconds.

### Maximum range (ack timeout)

*Only available in modes that support Local Mesh.*

Fine tunes internal timeout settings to account for the distance that a link spans. For normal operation, timeout is optimized for links of less than 1 km.

---

**NOTE:** This is a global setting that applies to all wireless connection made with the radio. Therefore, adjusting this setting may lower the performance for users with marginal signal strength or when interference is present. (Essentially, it means that if a frame needs to be retransmitted it will take longer before the actual retransmit takes place.)

---

### Distance between APs

*Not available in Monitor or Sensor modes.*

Use this parameter to adjust the receiver sensitivity of the AP only if you have a very dense deployment where many APs are close together. In all other cases, use the default setting of **Large**. If you have installed multiple APs, reducing the receiver sensitivity helps to keep clients with low signal quality from connecting, thereby increasing the probability that client stations connect with the nearest AP.

#### Available settings

- **Large:** Accepts all clients.
- **Medium:** Accepts clients with an RSSI greater than 15 dB.
- **Small:** Accepts clients with an RSSI greater than 20 dB.

---

**NOTE:** RSSI (Received Signal Strength Indication) is the difference between the amount of noise in an environment and the wireless signal strength. It is expressed in decibels (dB). The higher the number the stronger the signal.

---

### Beacon interval

*Not available in Monitor or Sensor modes.*

Sets the number of time units (TUs) that the AP waits between transmissions of the wireless beacon. One TU equals 1024 microseconds. The default interval is 100 TU, which is equal to 102.4 milliseconds. Supported range is from 20 to 500 TU.

### Multicast Tx rate

*Not available in Monitor or Sensor modes.*

Use this parameter to set the transmit rate for multicast and broadcast traffic. This is a fixed rate, which means that if a station is too far away to receive traffic at this rate, the multicast is not seen by the station.

On the MSM430, MSM460, MSM466, MSM466-R, and HP 560 the lowest supported value is 40 (even if you set a value in the range 20-39).

## Transmit power control

*Not available in Monitor or Sensor modes.*

Use these parameters to control the transmission power of the wireless radio.

Adjustments to the transmission power may be required for two reasons. First, when using an optional external antenna, it may be necessary to reduce power levels to remain in compliance with local regulations. Second, it may be necessary to reduce power levels to avoid interference between APs and other radio devices.

### Important

For a list of supported external antennas, see “[Connecting external antennas](#)” (page 131).

When using antennas not originally supplied with the AP, it is your responsibility to ensure that the **Transmit power control** settings are configured so that the radio will not exceed permissible power levels for the regulatory domain in which the AP is operating. Depending on the regulatory domain, the specific antenna chosen, the wireless mode, channel width, band or channel selected, you may need to configure the radio with a reduced transmit power setting. When using **Automatic channel selection** with an external antenna in the 2.4 GHz band, all channels must be set to the lowest acceptable value for your regulatory domain.

- ⚠ CAUTION:** For specific power limits according to your regulatory domain, consult the *Antenna Power-Level Settings Guide* available at [www.hp.com/support/manuals](http://www.hp.com/support/manuals). Search for the part number of your antenna.

For example, if you install an external 8 dBi directional antenna, and the maximum allowed power level for your country is 15 dBm, you may have to reduce the transmit power level to be in compliance.

If you change the antenna at a later time, you must get the latest version of the *Antenna Power-Level Settings Guide*, and again reassess and possibly adjust radio power settings according to the antenna used.

When setting **Transmit power control** to comply with information in the *Antenna Power-Level Settings Guide*, always set radio power in dBm, and not as a percentage.

## Maximum output power

Shows the maximum output power that can be supported by the radio based on the regulatory domain.

- **On the MSM410, MSM430, MSM460, HP 560:** Shows the maximum EIRP (Effective/Equivalent Isotropic Radiated Power) that can be delivered by the AP based on the regulatory domain. The displayed EIRP power is equivalent to the Conducted RF transmit power of the radio (dBm) plus the array gain of the antenna (dBi).
- **On the MSM466 and MSM466-R:** Shows the maximum conducted RF power (dBm) that can be delivered to the external antenna. The EIRP can be calculated by adding the antenna array gain (dBi).

## Use maximum power

Select this checkbox to use the maximum available output power.



### Set power to

Specify the transmission power in dBm or as a percentage of the maximum output power. When you click **Save**, percentage values are rounded up or down so that the dBm value is always a whole number.

Note that the actual transmit power used by the radio may be less than the specified value. The AP determines the maximum power to be used based on the regulatory domain.

Supported power levels are as follows:

- 0 - 20 dBm: MSM410, MSM422, MSM466, MSM466-R
- 5 - 25 dBm: MSM430, MSM460 operating at 2.4 GHz.
- 7 - 20 dBm: MSM430, MSM460 operating at 5 GHz.
- 15 - 29 dBm: HP 560 operating at 2.4 GHz.
- 16 - 28 dBm: HP 560 operating at 5 GHz.

### Automatic power control

Select this checkbox to have the AP automatically determine the optimal power setting within the defined power limits (i.e., up to the specified percentage/dBm value).

### Interval

Specify the interval at which the **Automatic power control** feature adjusts the optimal power setting.

## Neighborhood scanning

*Supported on: MSM410, HP 425, MSM430, MSM460, MSM466, MSM466-R, HP 560.*

*Not configurable when **Operating mode** is set to **Access point and Local mesh** or **Local mesh only**.*

### Scan ratio

(Not configurable when **Operating mode** is set to **Monitor**.)

The percentage of time the radio will spend scanning channels other than the operating channel.

### Dwell time

The amount of time (in milliseconds) that a radio remains on a channel while performing channel scanning. The default value is 30 milliseconds.

Set a value between 10 and 32 milliseconds when **Operating mode** is set to **Access point only**. (Use a value of 30 milliseconds on the MSM410.)

Set a value between 10 and 1000 milliseconds when **Operating mode** is set to **Monitor**.

### Scanning mode

- **Passive:** The AP listens to the channel to detect wireless traffic, but does not transmit any probes. The AP will receive beacon frames and probe response frames, and use them to identify neighbors. (When IDS is enabled, other frames are also received and sent to the IDS system for analysis.) The key point is that no frames are transmitted. This is the default setting.
- **Active:** The AP uses probe request frames to speed up neighbor detection. Active scanning only occurs on channels permitted by the regulatory domain. Transmission of probes is not allowed on DFS channels, so no probes are sent on DFS channels even when this option is selected.

### Bands to scan

*Not configurable in **Monitor mode**. The **All bands** option is automatically used.*

Not supported on the HP 560.

- **All bands:** Scan both 802.11 bands (2.4 GHz and 5 GHz).
- **Operating band only:** Scan only the band in which the radio is currently operating.

Recommended settings for single radio APs:

- With IDS disabled, select **Operating band only**.
- With IDS enabled, select **All bands**.

Recommended settings for dual radio APs:

- With IDS disabled, configure both radios for **Operating band only**.
- With IDS enabled, configure the 2.4 GHz radio for **Operating band only** (with a small scan ratio), and configure the 5 GHz radio for **All bands** (with a larger scan ratio). The 2.4 GHz band is probably much busier than the 5 GHz band, so IDS scanning using the 5 GHz radio has a reduced performance impact.

## Channels to scan

- **All channels:** Scan all channels supported by the current operating mode.
- **Regulatory channels only:** Scan only channels supported by the current regulatory domain (country).
- **Non-excluded channels only:** When enabled, the AP will not scan any channels in the **Automatic channel exclusion list**.

## Neighbor detection time

Estimated time in seconds to detect a neighbor.

## Wireless neighborhood

You can use the wireless neighborhood feature to discover the operating frequencies of radios in your area for site planning purposes.

It can also be used to flag discovered APs as either *authorized APs* or *rogue APs*. This is useful for monitoring the installation of wireless access points in your company's work areas to ensure that new APs (which could be a security risk if improperly configured) are not deployed without your knowledge.

## Scanning modes

The way in which the AP performs scanning depends on the configuration of the wireless radio. The following scanning modes are possible:

### Monitor mode

When a radio has its **Operating mode** set to **Monitor**, scanning occurs continuously. The scan switches to a new channel every 200 ms, sequentially covering all supported wireless modes and channels. Use this method to quickly obtain an overview of all APs in your area for site planning, or for initial configuration of the authorized access points list.

Monitor mode scanning is temporarily disabled when a trace is active (**Tools > Network trace** page).

## Automatic channel selection

When the **Automatic channel selection** feature is enabled, scanning occurs as follows:

- **On the MSM430, MSM460, MSM466, MSM466-R, HP 560:** Scanning only occurs when the channel selection interval expires. This may cause interruptions to voice calls. Therefore, configuring a short channel selection interval is not recommended.
- **On the MSM410, MSM422:** Scanning is continuously performed on all the channels in the currently selected **Operating mode**, even though the channel is only re-evaluated each time the channel selection interval expires. (If the interval is set to **Disabled**, continuous scanning is not performed.) Continuous scanning can cause interruptions to voice calls. On dual-radio APs, you can avoid interruptions by setting one radio to operate in monitor mode. For example, if radio 1 is set to automatic channel scanning and radio 2 is in monitor mode, scanning occurs on radio 2 and interruptions on radio 1 do not occur.

## Background scanning

*Supported on: MMSM410 and MSM422.*

For any other radio configuration, scanning is controlled by the settings on the **Network > Wireless neighborhood** page. To enable scanning, select the **Repeat scanning every xx seconds** checkbox and set a value. Scanning is performed for all the channels in the currently selected radio **Operating mode**. One channel is scanned during each scan interval. By default, the scan interval is set to 600 seconds. This is done to minimize the impact on radio throughput.

Use this method to continuously view APs operating in your area while minimizing the effect on throughput.

---

### NOTE:

- Scanning is temporarily disabled when a trace is active (**Tools > Network trace** page).
- To obtain the best possible wireless performance (such as needed for voice applications), scanning should be disabled.

When a radio is configured to support automatic channel selection, background scanning is only supported when the **Time of Day** option is selected for the automatic channel selection **Interval**.

---

## Viewing scan results

To view the results of the latest scan, open the **Wireless > Neighborhood** page. For example:

The scan repeat interval is determined automatically.

**Wireless neighborhood**

URL of list of authorized access points:

Repeat scan every:  seconds

**Unauthorized access points**

MAC address	SSID	Status	Mode	Channel	Signal	Noise	SNR	Info
XML version: <a href="#">Detailed</a> <a href="#">Brief</a>								

**All access points**

MAC address	SSID	Status	Mode	Channel	Signal	Noise	SNR	Info
00:23:51:be:28:61	HP	Ok	G	6 *	-73	-83	10	ESS WEP
00:03:52:f2:d5:b0	fruitbat	Ok	G	9	-22	-84	62	ESS WEP
00:24:a8:4b:e1:50	HP	Ok	G	1	-55	-84	29	ESS
00:03:52:1c:39:60	fruitbat	Ok	G	4	-28	-84	56	ESS WEP
00:24:a8:4b:b1:c0	HP	Ok	G	11	-56	-80	24	ESS

XML version: [Detailed](#) [Brief](#)

\* Frequency used by this access point  
 \*\* WPA or WPA2 Wireless Encryption Support

To update scanning results, select the refresh button in your browser.

## Identifying unauthorized APs

When an AP is discovered during a scan, its MAC address is compared against the list of authorized APs (which you must define). If the scanned AP does not appear in the list of authorized APs, it is displayed in the Unauthorized access points list.

## Creating the list of authorized APs

The list of authorized APs must be defined in an external file in XML format. Each entry in the file comprises two items: MAC address and SSID. Each entry should appear on a new line. The easiest way to create this file is to wait for a scan to complete, then open the list of all APs in **Brief** format. Edit this list so that it contains only authorized APs and save it. Then specify the address of this file under **List of authorized access points**.

## Viewing wireless information

### Viewing all wireless clients

To view information on all wireless client stations, select **Wireless > Overview**.

Wireless Overview											
Wireless client stations (Radio 1) ?											
Number of associated client stations: 1											
MAC address	IP address	VLAN	SSID	Authorized	Authentication	Association time	Signal	Noise	SNR	PMF	Action
80:BE:05:34:5E:D9	169.254.23.24		HP_560	Yes		0:00:37	-40	-91	51	Y	<a href="#">Disassociate</a>
Wireless client stations (Radio 2) ?											
Number of associated client stations: 1											
MAC address	IP address	VLAN	SSID	Authorized	Authentication	Association time	Signal	Noise	SNR	PMF	Action
98:FE:94:21:69:EF	169.254.116.52		HP_560_2	Yes		0:01:23	-29	-86	57	N	<a href="#">Disassociate</a>

This page lists all wireless clients associated with all VSCs.

## Settings

### MAC Address

MAC address of the client station. Select the MAC address to view more detailed information on the client.

### IP address

IP address assigned to the client station.

### Username

Name with which the user logged in.

### VLAN

VLAN assigned to the client station.

### SSID

SSID assigned to the client station.

### Authorized

- Yes: Client station has the right to transmit/receive traffic.
- No: Indicates that the client station can only transmit/receive 802.1X packets.
- Filtered: Indicates that traffic is blocked by a MAC filter.

### Authentication

Indicates how the station was authenticated 802.1X and/or MAC. If a station successfully authenticates with both 802.1X and MAC, only the 802.1X indication is shown.

### Association time

Indicates how long the client station has been associated with the AP.

### Signal

Indicates the strength of the radio signal received from client stations. Signal strength is expressed in decibel milliwatt (dBm). The higher the number the stronger the signal.

### Noise

Indicates how much background noise exists in the signal path between client stations and the AP. Noise is expressed in decibel milliwatt (dBm). The lower (more negative) the value, the weaker the noise.

## SNR

Indicates the relative strength of the client station radio signals versus the radio interference (noise) in the radio signal path.

In most environments, SNR is a good indicator for the quality of the radio link between the client stations and the AP. A higher SNR value means a better quality radio link.

## PMF

Indicates if 802.11w support (protected management frames) is enabled. (Only supported on the HP 560.)

## Action

Select **Disassociate** to disconnect a wireless client.

## Viewing wireless client data rates

To view information on all wireless client stations currently connected to the AP, select **Status > Client data rate matrix**.

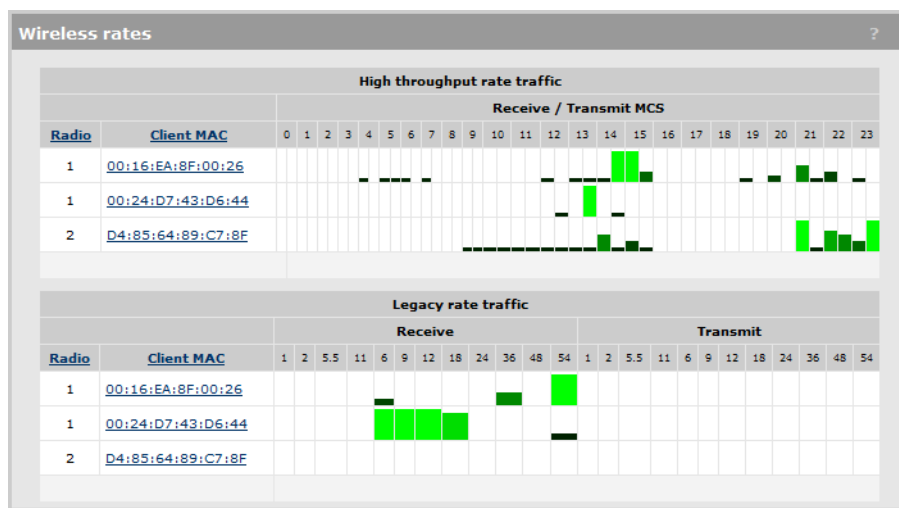

This page shows the volume of traffic sent and received at each data rate for each client station. Headings in bold indicate the data rates that are currently active for the wireless mode being used. Supported wireless rates depend on the AP model.

## Legacy rate traffic

Displays information for users connected via any 802.11 a/b/g mode. The size of the bar indicates the amount of traffic sent or received at each rate.

## High throughput (HT) rate traffic

Displays information for users connected via any 802.11 n mode. Rates are shown for each supported MCS (modulation coding scheme). The size of the bar indicates the amount of traffic sent or received at each MCS.

MCS	Data rates in Mbps			
	Channel width / Guard interval			
	20 MHz/ 800 ns	20 MHz/ 400 ns	40 MHz/ 800 ns	40 MHz/ 400 ns
0	6.50	7.20	13.50	15.00
1	13.00	14.4	47.00	30.00
2	19.50	21.70	40.50	45.00

MCS	Data rates in Mbps			
	Channel width / Guard interval			
	20 MHz/ 800 ns	20 MHz/ 400 ns	40 MHz/ 800 ns	40 MHz/ 400 ns
3	26.00	28.90	54.00	60.00
4	39.00	43.30	81.00	90.00
5	52.00	57.80	108.00	120.00
6	58.50	65.00	121.50	135.00
7	65.00	72.20	135.00	150.00
8	13.00	14.40	27.00	30.00
9	26.00	28.90	54.00	60.00
10	39.00	43.30	81.00	90.00
11	52.00	57.80	108.00	120.00
12	78.00	86.70	162.00	180.00
13	104.00	115.6	216.00	240.00
14	117.00	130.00	243.00	270.00
15	130.00	144.40	270.00	300.00
16	19.50	21.70	40.50	45.00
17	39.00	43.30	81.00	90.00
18	58.50	65.00	121.50	135.00
19	78.00	86.70	162.00	180.00
20	117.00	144.40	243.00	270.00
21	156.00	173.30	324.00	360.00
22	175.50	195.00	364.50	405.00
23	195.00	216.70	405.00	450.00

- MHz = megahertz
- ns = nanoseconds
- MCS 0 to MCS 15 are supported by the MSM410, MSM422, MSM430, MSM460, MSM466, MSM466-R, and HP 560.
- MCS 16 to MCS 23 are supported by the MSM460, MSM466, MSM466-R, and HP 560.
- For HT traffic, the MCS rate implies the number of spatial streams:
  - MCS 0 to 7: 1 spacial stream
  - MCS 8 to 15: 2 spacial stream
  - MCS 16 to 23: 3 spacial stream

### Very high throughput rate traffic

Displays information for users connected via 802.11ac. Rates are shown for each supported modulation coding scheme (MCS). The size of the bar indicates the amount of traffic sent at each MCS.

Supported rates vary depending as follows:

### One spacial stream

MCS	Data rates in Mbps - Nss=1					
	Channel width / Guard interval					
	20 MHz/ 800 ns	20 MHz/ 400 ns	40 MHz/ 800 ns	40 MHz/ 400 ns	80 MHz/ 800 ns	80 MHz/ 400 ns
0	6.50	7.20	13.50	15.00	29.3	32.5
1	13.00	14.4	47.00	30.00	58.5	65
2	19.50	21.70	40.50	45.00	87.8	97.5
3	26.00	28.90	54.00	60.00	117	130
4	39.00	43.30	81.00	90.00	175.5	195
5	52.00	57.80	108.00	120.00	234	260
6	58.50	65.00	121.50	135.00	263.3	292.5
7	65.00	72.20	135.00	150.00	292.5	325
8	13.00	14.40	27.00	30.00	351	390
9	26.00	28.90	54.00	60.00	390	433.3

### Two spatial streams

MCS	Data rates in Mbps - Nss=2					
	Channel width / Guard interval					
	20 MHz/ 800 ns	20 MHz/ 400 ns	40 MHz/ 800 ns	40 MHz/ 400 ns	80 MHz/ 800 ns	80 MHz/ 400 ns
0	13	14.4	27	30	58.5	65
1	26	28.9	54	60	117	130
2	39	43.3	81	90	175.5	195
3	52	57.8	108	120	234	260
4	78	86.7	162	180	351	390
5	104	115.6	216	240	468	520
6	117	130	243	270	526.5	585
7	130	144.4	270	300	585	650
8	156	173.3	324	360	702	780
9	n/a	n/a	360	400	780	866.7



## Three spatial streams

MCS	Data rates in Mbps - Nss=3					
	Channel width / Guard interval					
	20 MHz/ 800 ns	20 MHz/ 400 ns	40 MHz/ 800 ns	40 MHz/ 400 ns	80 MHz/ 800 ns	80 MHz/ 400 ns
0	19.5	21.7	40.5	45	87.8	97.5
1	39	43.3	81	90	175.5	195
2	58.5	65	121.5	135	263.3	292.5
3	78	86.7	162	180	351	390
4	117	130	243	270	526.5	585
5	156	173.3	324	360	702	780
6	175.5	195	364.5	405	n/a	n/a
7	195	216.7	405	450	877.5	975
8	234	260	496	540	1053	1170
9	260	288.9	540	600	1170	1300

- MHz = megahertz
- ns = nanoseconds
- VHT MCS 0 to MCS 9 are supported by the HP 560.
- On the HP 517, the guard interval is not configurable. It is always set to 400 ns, but will downgrade to 800 ns based on the capability of connected clients or the wireless environment.

## Wireless access points

To view wireless information for an AP, select **Status > Wireless**.

The information you see will vary depending on the AP. For example, this is the status page for an MSM460:

Access point status		Radio 1	?
● <b>Wireless Port is UP</b>			
Frequency:	<b>Channel 52, 5.260GHz</b>		
Wireless mode:	<b>802.11n/a (5 GHz)</b>		
Operating mode:	<b>AP only</b>		
Tx power:	<b>7 dBm (EIRP)</b>		
Transmit protection status	<b>Disabled</b>		
Tx multicast octets:	<b>15929</b>	Rx multicast octets:	<b>16565</b>
Tx unicast octets:	<b>187790</b>	Rx unicast octets:	<b>57043</b>
Tx broadcast octets:	<b>9154</b>	Rx broadcast octets:	<b>8932</b>
Tx fragments:	<b>2998</b>	Rx fragments:	<b>2998</b>
Tx multicast frames:	<b>106</b>	Rx multicast frames:	<b>99</b>
Tx unicast frames:	<b>382</b>	Rx unicast frames:	<b>381</b>
Tx broadcast frames:	<b>67</b>	Rx broadcast frames:	<b>60</b>
Tx discards wrong SA:	<b>0</b>	Rx discards no buffer:	<b>0</b>
Tx discards:	<b>0</b>	Rx discards WEP excluded:	<b>0</b>
Tx retry limit exceeded:	<b>0</b>	Rx discards WEP ICV error:	<b>0</b>
Tx multiple retry frames:	<b>1106</b>	Rx msg in bad msg fragments:	<b>0</b>
Tx single retry frames:	<b>2884</b>	Rx msg in msg fragments:	<b>550602</b>
Tx deferred transmissions:	<b>0</b>	Rx WEP undecryptable:	<b>0</b>
QoS low priority tx:	<b>0</b>	Rx FCS errors:	<b>36987</b>
QoS medium priority tx:	<b>485</b>		
QoS high priority tx:	<b>0</b>		
QoS very high priority tx:	<b>3</b>		
<a href="#">Clear Counters</a>			

## Access point status

### Wireless port

- **Up:** Port is operating normally.
- **Down:** Port is not operating.

### Frequency

The current operating frequency.

### Wireless mode

Current wireless mode.

### Operating mode

Current operating mode.

### Tx power

Current transmission power.

### Transmit protection status

- **Disabled:** HT protection / G protection is disabled.
- **B clients:** G protection is enabled because a B client is connected to the AP.
- **B APs:** G protection is enabled because a B client is connected to another AP on the same channel used by the AP.
- **AG clients:** HT protection is enabled because a non-HT client is connected to the AP.
- **AG APs:** HT protection is enabled because a non-HT AP is present on the same channel used by the AP.

### Tx multicast octets

The number of octets transmitted successfully as part of successfully transmitted multicast MSDUs. These octets include MAC Header and Frame Body of all associated fragments.

**Tx unicast octets**

The number of octets transmitted successfully as part of successfully transmitted unicast MSDUs. These octets include MAC Header and Frame Body of all associated fragments.

**Tx fragments**

The number of MPDUs of type Data or Management delivered successfully; i.e., directed MPDUs transmitted and being ACKed, as well as non-directed MPDUs transmitted.

**Tx multicast frames**

The number of MSDUs, of which the Destination Address is a multicast MAC address (including broadcast MAC address), transmitted successfully.

**Tx unicast frames**

The number of MSDUs, of which the Destination Address is a unicast MAC address, transmitted successfully. This implies having received an acknowledgment to all associated MPDUs.

**Tx discards wrong SA**

The number of transmit requests that were discarded because the source address is not equal to the MAC address.

**Tx discards**

The number of transmit requests that were discarded to free up buffer space on the AP. This can be caused by packets being queued too long in one of the transmit queues, or because too many retries and defers occurred, or otherwise not being able to transmit (for example, when scanning).

**Tx retry limit exceeded**

The number of times an MSDU is not transmitted successfully because the retry limit is reached, due to no acknowledgment or no CTS received.

**Tx multiple retry frames**

The number of MSDUs successfully transmitted after more than one retransmission (on the total of all associated fragments). May be due to collisions, noise, or interference. Excessive retries can indicate that too many computers are using the wireless network or that something is interfering with transmissions.

**Tx single retry frames**

The number of MSDUs successfully transmitted after one (and only one) retransmission (on the total of all associated fragments). May be due to collisions, noise, or interference. Large numbers of single retries can indicate that too many computers are using the wireless network or that something is interfering with transmissions.

**Tx deferred transmissions**

The number of MSDUs for which (one of) the (fragment) transmission attempt(s) was one or more times deferred to avoid a collision. Large numbers of deferred transmissions can indicate that too many computers are using the wireless network.

**QoS low priority tx**

Total number of QoS low priority packets that have been sent.

**QoS medium priority tx**

Total number of QoS medium priority packets that have been sent.

**QoS high priority tx**

Total number of QoS high priority packets that have been sent.

**QoS very high priority tx**

Total number of QoS very high priority packets that have been sent.

**Tx packets**

*Not shown on the MSM410, MSM430, MSM460, MSM466, and MSM466-R.*

The total number of packets transmitted.

**Tx dropped**

*Not shown on the MSM410, MSM430, MSM460, MSM466, and MSM466-R.*

The number of packets that could not be transmitted. This can occur when the wireless configuration is being changed.

**Tx errors**

*Not shown on the MSM410, MSM430, MSM460, MSM466, and MSM466-R.*

The total number of packets that could not be sent due to the following errors: Rx retry limit exceeded and TX discards wrong SA.

**Rx packets**

*Not shown on the MSM410, MSM430, MSM460, MSM466, and MSM466-R.*

The total number of packets received.

**Rx dropped**

*Not shown on the MSM410, MSM430, MSM460, MSM466, and MSM466-R.*

The number of received packets that were dropped due to lack of resources on the AP. This should not occur under normal circumstances. A possible cause could be if many client stations are continuously transmitting small packets at a high data rate.

**Rx multicast octets**

The number of octets received successfully as part of multicast (including broadcast) MSDUs. These octets include MAC Header and Frame Body of all associated fragments.

**Rx unicast octets**

The number of octets received successfully as part of unicast MSDUs. These octets include MAC Header and Frame Body of all associated fragments.

**Rx fragments**

The number of MPDUs of type Data or Management received successfully.

**Rx multicast frames**

The number of MSDUs, with a multicast MAC address (including the broadcast MAC address), as the Destination Address, received successfully.

**Rx unicast frames**

The number of MSDUs, with a unicast MAC address as the Destination Address received successfully.

**Rx discards no buffer**

The number of received MPDUs that were discarded because of lack of buffer space.

**Rx discards WEP excluded**

The number of discarded packets, excluding WEP-related errors.

**Rx discards WEP ICV error**

The number of received MPDUs that were discarded due to malformed WEP packets.

**Rx MSG in bad msg fragments**

The number of MPDUs of type Data or Management received successfully, while there was another reception going on above the carrier detect threshold but with bad or incomplete PLCP Preamble and Header (the message-in-message path #2 in the modem).

**Rx MSG in msg fragments**

The number of MPDUs of type Data or Management received successfully, while there was another good reception going on above the carrier detect threshold (the message-in-message path #2 in the modem).

**Rx WEP undecryptable**

The number of received MPDUs, with the WEP subfield in the Frame Control field set to one, that were discarded because it should not have been encrypted or due to the receiving station not implementing the privacy option.

**Rx FCS errors**

The number of MPDUs, considered to be destined for this station (Address matches), received with an FCS error. Note that this does not include data received with an incorrect CRC in the PLCP header. These are not considered to be MPDUs.

**Clear counters**

Select this button to reset all counters to zero.

# 5 Working with VSCs

## Key concepts

A VSC (virtual service community) is a collection of configuration settings that define key operating characteristics of an AP. In most cases, a VSC is used to define the characteristics of a wireless network.

Multiple VSCs can be active at the same time, allowing for great flexibility in the configuration of services. Up to 64 VSC profiles can be configured, provided proper licensing is used.

In the following scenario, four VSCs are used to support different types of wireless users. Each VSC is configured with a different wireless network name (SSID), and the quality of service (QoS) feature is used to classify user traffic priority.

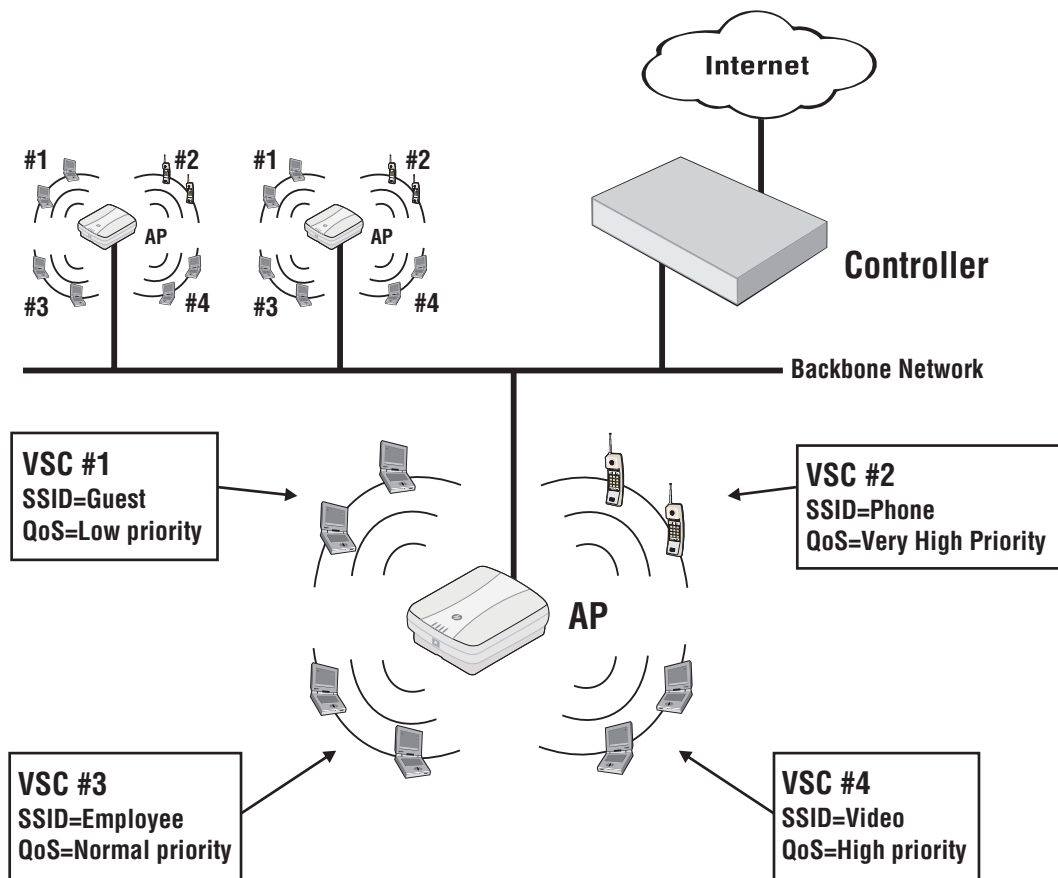

## Stand-alone deployment

An autonomous AP can be deployed as a stand-alone device to provide wireless networking support for an existing wired network. The AP essentially creates a wireless extension to the existing wired network, bridging wireless users onto the wired backbone.

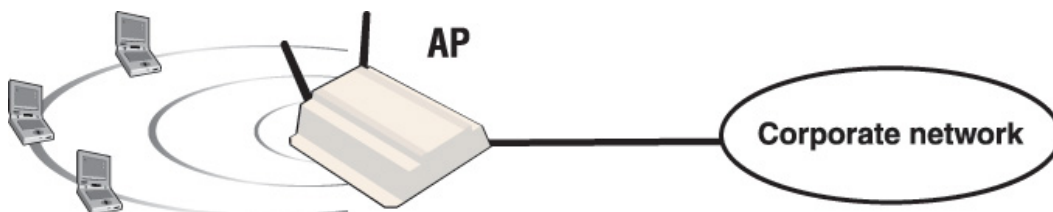

## User authentication

The AP can validate user login credentials using a third-party RADIUS server. The following authentication types are supported: WPA / WPA2, 802.1X, and MAC.

### WPA / WPA2 and 802.1X authentication

Full support is provided for users with WPA / WPA2 client software, and 802.1X client software that uses the following:

- EAP-TLS: Extensible Authentication Protocol Transport Layer Security.
- EAP-TTLS: Extensible Authentication Protocol Tunnelled Transport Layer Security.
- PEAP: Protected Extensible Authentication Protocol.

---

**NOTE:** For security reasons, use of 802.1X without enabling dynamic WEP encryption is not recommended.

---

### MAC-based authentication

Devices can be authenticated based on their MAC address. This is useful for authenticating devices that do not have a web browser (cash registers, for example). As soon as the device MAC address appears on the network, the AP attempts to authenticate it.

## Using more than one authentication type in a VSC

For added flexibility, you can enable both the 802.1X and VSC-based MAC authentication at the same time. MAC authentication always takes place first. If it fails, 802.1X is then attempted.

## Deployment with a controller

Autonomous APs can also be used with a controller to create a public access network infrastructure. In this type of deployment, all VSCs are access-controlled, which means that the AP forwards all wireless user traffic to the controller which handles user authentication and access control.

To reach protected network resources, wireless users must successfully authenticate with the public access interface that is provided by the controller.

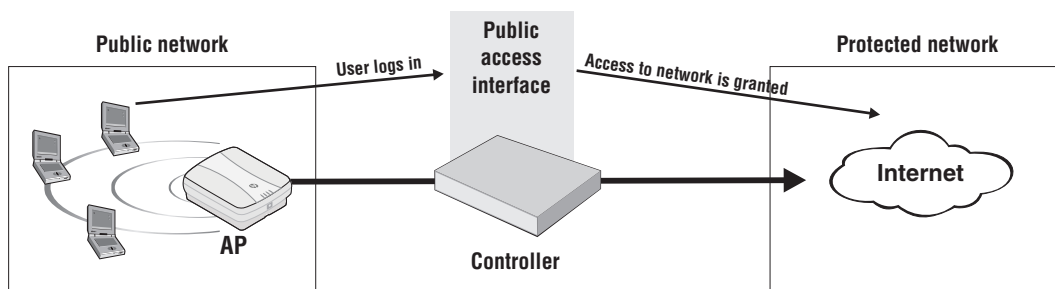

The following authentication types are supported on the controller: WPA / WPA2, 802.1X, MAC, HTML. For more information on controller authentication features, see the *MSM7xx Controllers Configuration Guide*.

In this type of installation, VSC definitions on both the AP and controller must match so that traffic from wireless users connected to the AP can be sent to the controller for handling. For example, if two VSCs are being used, they could be configured as follows:

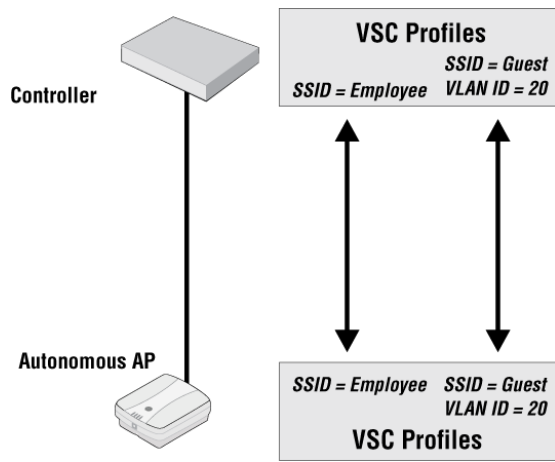

## Management with VLANs

When operating in a VLAN environment, management traffic can be carried on its own VLAN. Configure the VSC on both the autonomous AP and the controller as illustrated.

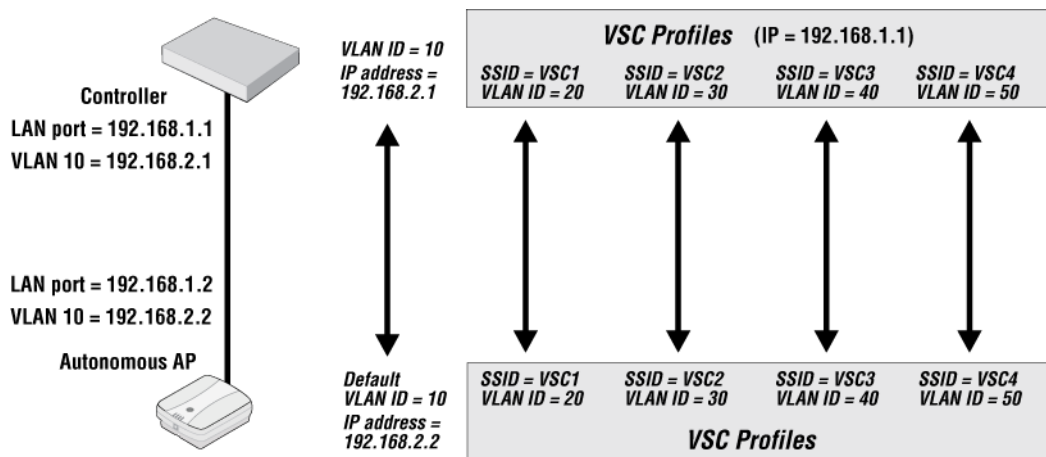

In this example, the traffic for each wireless network is carried on its own VLAN. This leaves only management traffic from the autonomous AP on VLAN 10. A static IP is assigned on both ends to permit the two devices to communicate.

## Viewing and editing VSC profiles

Select **VSC** on the main menu to open the VSC page. This page lists all defined VSC profiles and enables you to add new ones.

Virtual Service Communities												
Name	Ingress		Egress	QoS	Filtering		Encryption			Authentication		Radios
	SSID	VLAN	VLAN		IP	MAC	TKIP	AES	WEP	802.1x	MAC	
HP	HP	-	-	DiffSrv	-	-	-	-	-	-	-	1

Add New VSC Profile...

= Use access controller   
 = SSID Off   
 = SSID On   
 = SSID On and configured for broadcast

The **HP** VSC profile is defined by default.

- To edit an existing profile, select its **Name**.
- To add a new profile, select **Add New VSC Profile**.



In either case, the **Add/Edit Virtual Service Community** page opens providing all VSC profile options.

**Add/Edit Virtual Service Community**

**General**

Name: HP

Use HP MSM Controller

**Virtual AP**

**WLAN**

Name (SSID): HP

DTIM count: 1

Transmit/receive on: Radio 1

Broadcast name (SSID)

Advertise TX power

**Wireless protection** WPA

Mode\*: WPA2 (AES/CCMP)

Key source: RADIUS

RADIUS profile: <No RADIUS defined>

RADIUS accounting

RADIUS profile: <No RADIUS defined>

Called-Station-Id Content: BSSID

Station ID delimiter: Dash: \'.'

Station ID MAC case: Upper case

\*On radios in pure 802.11n mode WPA2 is always used instead of WPA

The following sections provide an overview of each VSC option and how it is used. For complete descriptions of individual parameters see the online help in the management tool.

## VSC configuration options

This section provides an overview of all the configuration options available for a VSC. It will give you a good idea on how the features can be used.

The default VSC is pre-configured as described in the following pages. Below, is an overview of the entire VSC configuration page.

### Add/Edit Virtual Service Community

**General** ?

Name:

Use HP MSM Controller

**Virtual AP** ?

**WLAN**

Name (SSID):

DTIM count:

Transmit/receive on:

Broadcast name (SSID)

Advertise TX power

Broadcast filtering

**Wireless clients**

Max clients per radio:

Allow traffic between:  wireless clients

**Quality of service**

Priority mechanism:

IP QoS profiles:

Upstream DiffServ tagging

Enable WMM advertising

**Allowed wireless rates (advanced)**

**Egress VLAN** ?

VLAN ID:

**Wireless security filters** ?

Restrict wireless traffic to:

MSM422 default gateway

MAC address:

Custom:

**Wireless protection** WPA ?

Mode\*:

Key source:

RADIUS profile:

RADIUS accounting

RADIUS profile:

Called-Station-Id Content:

Station ID delimiter:

Station ID MAC case:

\*On radios in pure 802.11n mode WPA2 is always used instead of WPA

**MAC-based authentication** ?

RADIUS Profile:

RADIUS accounting

RADIUS Profile:

Station ID delimiter:

Station ID MAC case:

Called-Station-Id Content:

**MAC filter** ?

MAC Address list:

Filter action:  Allow  Block

**IP filter** ?

Only allow traffic addressed to:

IP address / Mask

/

## General

Availability of certain VSC features and their functionality are dependent on the setting of the **Use HP MSM Controller** in the **General** box. This option determines how authentication and access control are handled by the VSC.

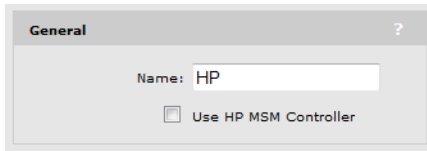

### If the *Use HP MSM Controller* option is enabled

This creates an **access-controlled VSC**, which means that the AP must be used in conjunction with a controller because the VSC is automatically configured to forward all user traffic to the controller for authentication (**Wireless protection** and **MAC-based authentication** options are forced to use the controller as the RADIUS server). Also, once authenticated, user traffic is restricted by the **Wireless security filters** option. Only traffic addressed to the controller is permitted. (These filters can be disabled if required.)

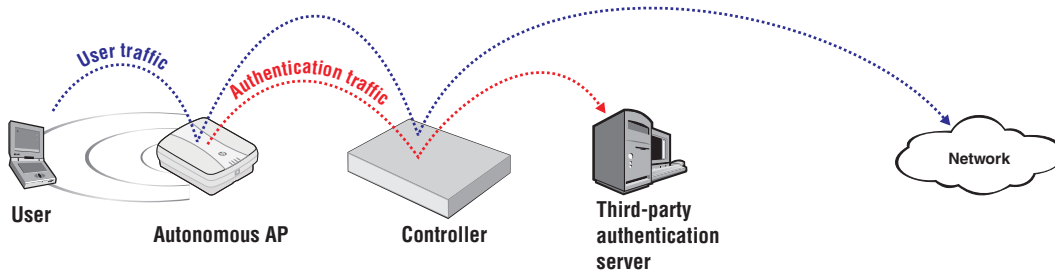

### If the *Use HP MSM Controller* option is disabled

This creates a **non-access-controlled VSC**, which allows the AP to operate independent of a controller and manage user authentication itself using the services of a third-party RADIUS server. Once authenticated, user traffic is restricted to the default gateway assigned to the AP by the **Wireless security filters** option. (These filters can be disabled or re-configured if required.)

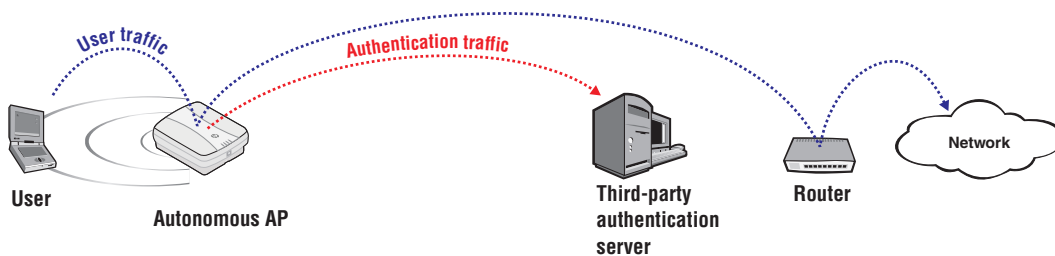

**NOTE:** When access control is disabled, user traffic sent by the AP must bypass the controller, otherwise it will be interpreted and processed.

The following table shows how VSC configuration options are affected by setting the **Use HP MSM controller** option.

VSC option	The <i>Use HP MSM Controller</i> option is ...	
	Enabled	Disabled
Virtual AP	Available.	Available.
Egress VLAN	Available.	Available.
Wireless security filters	Available, but wireless traffic is restricted to the controller.	Available, but wireless traffic is restricted to the default gateway. Can be changed.

VSC option	The Use HP MSM Controller option is ...	
	Enabled	Disabled
Wireless protection	Available, but user authentication must be performed by the controller.	Available. User authentication can be performed by any external RADIUS server.
MAC-based authentication	Available, but user authentication must be performed by the controller.	Available. User authentication can be performed by any external RADIUS server.
Location-aware	Available.	Not available.
MAC filter	Available.	Available.
Wireless IP filter	Available.	Available.

## Virtual AP

The virtual AP settings define the characteristics of the wireless network created by the VSC, including its name, the number of clients supported, and QoS settings.

### APs with a single radio

### APs with dual radios

Select the **Virtual AP** checkbox to enable the wireless network defined by this VSC.

## WLAN

### Settings

#### Name (SSID)

Specify a name to uniquely identify the wireless network associated with this VSC. The wireless network is created by the controlled APs and managed by the controller.

Each wireless user that wants to connect to this VSC must use the WLAN name. The name is case-sensitive.

### **DTIM count**

Specify the DTIM period in the wireless beacon. Client stations use the DTIM to wake up from low-power mode to receive multicast traffic.

APs transmit a beacon every 100 ms. The DTIM counts down with each beacon that is sent. Therefore if the DTIM is set to 5, then client stations in low-power mode will wake up every 500 ms (.5 second) to receive multicast traffic.

### **Transmit/receive on**

Select the radio on which this VSC will transmit and receive.

### **Broadcast name (SSID)**

When this option is enabled, APs will broadcast the wireless network name (SSID) to all client stations. Most wireless adapter cards have a setting that enables them to automatically discover APs that broadcast their names and connect to the one with the strongest signal.

If you disable this option, client stations will have to specify the network name you enter for **Name (SSID)** when they connect.

### **Advertise Tx power**

*Not supported on: MSM410, MSM430, MSM460, MSM466, MSM466-R, HP 560).*

When this option is enabled, APs broadcast their current transmit power setting in the wireless beacon. It also enables support for 802.11h and 802.11d.

### **Broadcast filtering**

Use this option to conserve wireless bandwidth by filtering out non-essential broadcast traffic. When broadcast filtering is enabled:

- DHCP broadcast requests are never forwarded on the wireless port.
- DHCP broadcast offers are never forwarded on the wireless port unless the target of the offer is an associated client on the wireless interface.
- ARP broadcast requests are never forwarded out the wireless port unless the target of the ARP request is an associated client on the wireless interface.

Broadcast filtering should be disabled in the following cases:

- An external DHCP server is connected to the wireless network.
- If a wireless client bridge is connected to the wireless network.

### **Band steering**

*Supported on: MSM422, MSM430, MSM460, MSM466, MSM466-R, HP 560.*

Band steering is used to help solve dense client issues. When band steering is enabled, APs attempt to move wireless clients that are capable of 802.11 a/n onto the 5 GHz band, thus reducing the load on the slower and more crowded 2.4 GHz band, leaving it for less capable legacy (802.11 b/g) clients.

An AP uses the following methods to encourage a wireless client to associate at 5 GHz instead of 2.4 GHz.

- The AP waits 200 ms before responding to the first probe request sent by a client at 2.4 GHz.
- If the AP has learned that a client is capable of transmitting at 5 GHz, the AP refuses the first association request sent by the client at 2.4 GHz.
- Once a client is associated at 5 GHz, the AP will not respond to any 2.4 GHz probes from the client as long as the clients signal strength at 5 GHz is greater than -80 dBm (decibel milliwatt). If the clients signal strength falls below -80 dBm, then the AP will respond to 2.4 GHz probes from the client without delay.

---

**NOTE:**

- To support band steering, the VSC must be bound to APs with two radios. One radio must be configured for 2.4 GHz operation and the other for 5 GHz operation.
  - Band steering is temporarily suspended on an AP when the radio configured for 5 GHz operation reaches its maximum number of supported clients.
- 

## Wireless clients

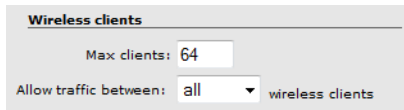

Wireless clients

Max clients: 64

Allow traffic between: all wireless clients

### Settings

#### Max clients per radio

Specify the maximum number of wireless client stations that can be associated with this SSID at the same time on each radio. On dual radio products the limit applies separately on each radio. The HP 560 supports a maximum of 128 simultaneous wireless clients on all active VSCs.

#### Allow traffic between non wireless clients

Use this option to control how non-access-controlled wireless clients that are connected to the same VSC can communicate with each other. The following settings are available:

- **no**: Blocks all inter-client communications.
- **802.1X**: Only authenticated 802.1X clients can communicate.
- **all**: All authenticated and unauthenticated clients can communicate. Default setting.
- **IPv6**: Only authenticated clients using IP version 6 can communicate.

Communication between users connected to different non-access-controlled VSCs can only occur if the same VLAN is assigned in the **Egress VLAN** option for both VSCs.

For example, to support traffic between authenticated users on two different VSCs, the **Authenticated** option under **VSC egress mapping** must be set to the same VLAN on both VSCs.

In addition, the following rules govern how traffic is exchanged:

- Unicast traffic exchanged between VSCs on the **same** radio is controlled by the setting of either the sender's or the receiver's VSC.
- Unicast traffic exchanged between VSCs on **different** radios is controlled by the setting of the sender's VSC.
- Multicast traffic exchanged between VSCs is always controlled by the setting of the sender's VSC.

Generally, most clients will be involved in the bidirectional exchange of unicast packets. In this case, the rules can be simplified by assuming that the most restrictive setting for this option takes precedence. For example:

- If VSC1 is set to **No** and VSC2 is set to **All**, no communication is permitted between clients on the two VSCs, or between clients on VSC1. However, all clients on VSC2 can communicate with each other.
- If VSC1 is set to **802.1X** and VSC2 set to **All**, only 802.1X clients can communicate between the two VSCs.

## Quality of service

The quality of service (QoS) feature provides a number of different mechanisms to prioritize wireless traffic sent to wireless client stations. See “Quality of service” (page 80).

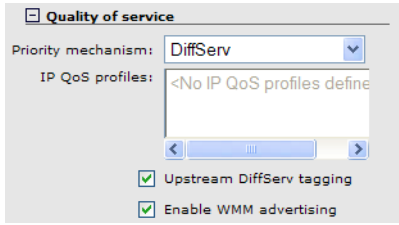

## Allowed wireless rates

Select the wireless transmission speeds (in Mbps) that this VSC will support for each wireless mode. Clients will only be able to connect at the rates that you select. If a client does not support the selected rate and mode, it will not be able to connect to this VSC.

Allowed wireless rates

802.11b	802.11g	802.11b+g	802.11a	802.11n	802.11ac
<input checked="" type="checkbox"/> 1	<input checked="" type="checkbox"/> 6	<input checked="" type="checkbox"/> 1	<input checked="" type="checkbox"/> 6	<input checked="" type="checkbox"/> 1	<input checked="" type="checkbox"/> 6
<input checked="" type="checkbox"/> 2	<input checked="" type="checkbox"/> 9	<input checked="" type="checkbox"/> 2	<input checked="" type="checkbox"/> 9	<input checked="" type="checkbox"/> 2	<input checked="" type="checkbox"/> 9
<input checked="" type="checkbox"/> 5.5	<input checked="" type="checkbox"/> 12	<input checked="" type="checkbox"/> 5.5	<input checked="" type="checkbox"/> 12	<input checked="" type="checkbox"/> 5.5	<input checked="" type="checkbox"/> 12
<input checked="" type="checkbox"/> 11	<input checked="" type="checkbox"/> 18	<input checked="" type="checkbox"/> 6	<input checked="" type="checkbox"/> 18	<input checked="" type="checkbox"/> 6	<input checked="" type="checkbox"/> 18
	<input checked="" type="checkbox"/> 24	<input checked="" type="checkbox"/> 9	<input checked="" type="checkbox"/> 24	<input checked="" type="checkbox"/> 9	<input checked="" type="checkbox"/> 24
	<input checked="" type="checkbox"/> 36	<input checked="" type="checkbox"/> 11	<input checked="" type="checkbox"/> 36	<input checked="" type="checkbox"/> 11	<input checked="" type="checkbox"/> 36
	<input checked="" type="checkbox"/> 48	<input checked="" type="checkbox"/> 12	<input checked="" type="checkbox"/> 48	<input checked="" type="checkbox"/> 12	<input checked="" type="checkbox"/> 48
	<input checked="" type="checkbox"/> 54	<input checked="" type="checkbox"/> 18	<input checked="" type="checkbox"/> 54	<input checked="" type="checkbox"/> 18	<input checked="" type="checkbox"/> 54
		<input checked="" type="checkbox"/> 24		<input checked="" type="checkbox"/> 24	<input checked="" type="checkbox"/> MCS 0
		<input checked="" type="checkbox"/> 36		<input checked="" type="checkbox"/> 36	<input checked="" type="checkbox"/> MCS 1
		<input checked="" type="checkbox"/> 48		<input checked="" type="checkbox"/> 48	<input checked="" type="checkbox"/> MCS 2
		<input checked="" type="checkbox"/> 54		<input checked="" type="checkbox"/> 54	<input checked="" type="checkbox"/> MCS 3
				<input checked="" type="checkbox"/> MCS 0	<input checked="" type="checkbox"/> MCS 4
				<input checked="" type="checkbox"/> MCS 1	<input checked="" type="checkbox"/> MCS 5
				<input checked="" type="checkbox"/> MCS 2	<input checked="" type="checkbox"/> MCS 6
				<input checked="" type="checkbox"/> MCS 3	<input checked="" type="checkbox"/> MCS 7
				<input checked="" type="checkbox"/> MCS 4	<input checked="" type="checkbox"/> MCS 8
				<input checked="" type="checkbox"/> MCS 5	<input checked="" type="checkbox"/> MCS 9
				<input checked="" type="checkbox"/> MCS 6	<input checked="" type="checkbox"/> MCS 10
				<input checked="" type="checkbox"/> MCS 7	<input checked="" type="checkbox"/> MCS 11
				<input checked="" type="checkbox"/> MCS 8	<input checked="" type="checkbox"/> MCS 12
				<input checked="" type="checkbox"/> MCS 9	<input checked="" type="checkbox"/> MCS 13
				<input checked="" type="checkbox"/> MCS 10	<input checked="" type="checkbox"/> MCS 14
				<input checked="" type="checkbox"/> MCS 11	<input checked="" type="checkbox"/> MCS 15
				<input checked="" type="checkbox"/> MCS 12	<input checked="" type="checkbox"/> MCS 16
				<input checked="" type="checkbox"/> MCS 13	<input checked="" type="checkbox"/> MCS 17
				<input checked="" type="checkbox"/> MCS 14	<input checked="" type="checkbox"/> MCS 18
				<input checked="" type="checkbox"/> MCS 15	<input checked="" type="checkbox"/> MCS 19
				<input checked="" type="checkbox"/> MCS 16	<input checked="" type="checkbox"/> MCS 20
				<input checked="" type="checkbox"/> MCS 17	<input checked="" type="checkbox"/> MCS 21
				<input checked="" type="checkbox"/> MCS 18	<input checked="" type="checkbox"/> MCS 22
				<input checked="" type="checkbox"/> MCS 19	<input checked="" type="checkbox"/> MCS 23
				<input checked="" type="checkbox"/> MCS 20	Nss=1 <input type="text" value="VHT MCS 0-9"/>
				<input checked="" type="checkbox"/> MCS 21	Nss=2 <input type="text" value="VHT MCS 0-9"/>
				<input checked="" type="checkbox"/> MCS 22	Nss=3 <input type="text" value="VHT MCS 0-9"/>
				<input checked="" type="checkbox"/> MCS 23	

All APs do not support all wireless modes and rates.

- **MCS 0 to MCS 15** are supported by the MSM410, MSM422, MSM430, MSM460, MSM466, MSM466-R, and HP 560.
- **MCS 16 to MCS 23** are supported by the MSM460, MSM466, MSM466-R, and HP 560.
- **VHT MCS 0 to MCS 9** are supported by the HP 560.

To ensure a high quality of service for voice applications, disable all rates below 5.5. Also, ensure that the radio is configured as follows:

- **Operating mode** is set to **Access point only**.
- **Channel** is set to a fixed channel, or **Automatic** with **interval** set to **Disabled**.
- **Automatic power control** is disabled under **Transmit power control**.
- On the **Wireless > Neighborhood** page, do not enable the **Repeat scan every nnn seconds** option.

#### Notes on 802.11ac/n

- 802.11n supports legacy rates (1 to 54), as well as high-throughput (HT) rates MCS 0 to MCS 23.
- You must always enable at least one legacy rate for 802.11n.
- 802.11ac supports legacy rates (6 to 54), as well as high-throughput (HT) rates MCS 0 to MSC 23, and very high-throughput (VHT) rates MCS 0 to MSC 9. The supported VHT rates are configurable depending on the number of spacial streams (Nss): 1, 2, or 3.
- VHT MCS 9 is not supported for Nss=1 or 2 when using the 20 MHz channel width.
- VHT MCS 6 is not supported for Nss=3 when using the 80 MHz channel width.

#### Note regarding the MSM430, MSM460, MSM466, and MSM466-R

On these products, the wireless rates shown for 802.11n apply to all wireless modes supported on both radios, which are 802.11/a/b/g/n. If you remove a rate, it is removed for all wireless modes.

## Egress VLAN

Sets the VLAN to which this profile forwards traffic. If you do not select a VLAN, traffic is sent untagged. VLANs can also be assigned using other methods, some of which may override the Egress VLAN. See [“Working with VLANs” \(page 89\)](#) for details.

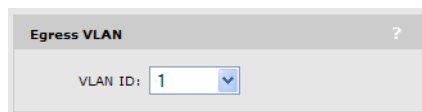

The screenshot shows a configuration window titled "Egress VLAN" with a question mark icon. Below the title is a dropdown menu labeled "VLAN ID:" with the number "1" selected.

## Wireless security filters

APs feature an intelligent bridge that can apply security filters to safeguard the flow of wireless traffic. These filters limit both incoming and outgoing traffic as defined below and force the APs to exchange traffic with a specific upstream device.

### Settings

If **Use HP MSM Controller** is enabled under **General**, the AP will only forward user traffic that is addressed to the MSM7xx controller defined on the **Security > Access controller** page. All other traffic is blocked. Make sure that the access controller is set as the default gateway for all wireless users. If not, user traffic will be blocked by the AP. The default wireless security filters are in effect.

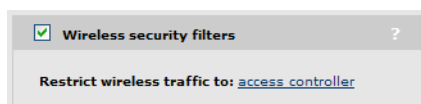

The screenshot shows a configuration window titled "Wireless security filters" with a question mark icon. A checkbox is checked, and below it, the text reads "Restrict wireless traffic to: [access controller](#)".

Select the **access controller** link to open the **Security > Access controller** page where you can configure access controller options.



If **Use HP MSM Controller** is disabled under **General**, then you can manually configure the security filters as required using the following options.

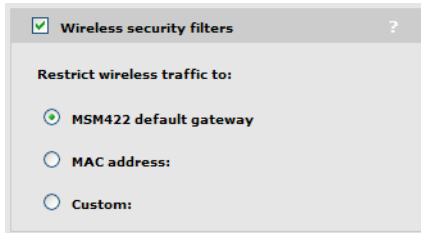

- **AP-name default gateway:** The AP will only forward user traffic that is addressed to default gateway assigned on the **Network > Ports** page (via DHCP, PPPoE, or static addressing options).
- **MAC address:** The AP will only forward user traffic that is addressed to the upstream device with the specified MAC address. Make sure that this device is set as the default gateway for all wireless users. If not, user traffic will be blocked by the AP.
- **Custom:** Lets you define custom inbound and outbound security filters. To use the default filters as a starting point, select **Get Default Filters**.

Filters are specified using standard pcap syntax with the addition of a few HP-specific placeholders. These placeholders can be used to refer to specific MAC addresses and are expanded by the AP when the filter is activated. Once expanded, the filter must respect the pcap syntax. The pcap syntax is documented in the tcpdump man page:

[http://www.tcpdump.org/tcpdump\\_man.html](http://www.tcpdump.org/tcpdump_man.html)

#### Placeholders

- `%a%a` : MAC address of the AP.
- `%b%b` : MAC address of the bridge.
- `%g%g` : MAC address of the default gateway assigned to the AP.
- `%w%w` : MAC address of AP wireless port.

#### Default wireless security filter definitions

The following filters are defined by default.

##### Incoming wireless traffic filters

Applies to traffic sent from wireless users to the AP.

##### Accepted

- Any IP traffic addressed to the controller.
- PPPoE traffic (The PPPoE server must be the upstream device.)
- IP broadcast packets, except NetBIOS
- Certain address management protocols (ARP, DHCP) regardless of their source address.
- Any traffic addressed to the AP, including 802.1X.

## Blocked

- All traffic that is not accepted is blocked. This includes NetBIOS traffic regardless of its source/destination address. HTTPS traffic not addressed to the AP (or upstream device) is also blocked, which means wireless users cannot access the management tool on other HP APs.

## Outgoing wireless traffic filters

Applies to traffic sent from the AP to wireless users.

### Accepted

- Any IP traffic coming from the upstream device, except NetBIOS packets.
- PPPoE traffic from the upstream device.
- IP broadcast packets, except NetBIOS
- ARP and DHCP Offer and ACK packets.
- Any traffic coming from the AP itself, including 802.1X.

### Blocked

- All other traffic is blocked. This includes NetBIOS traffic regardless of its source/destination address.

## Custom wireless security filter definitions

Use this option to define your own security filters to control incoming and outgoing wireless traffic. To use the default filters as a starting point, select **Get Default Filters**.

Filters are specified using standard pcap syntax with the addition of a few HP-specific placeholders. These placeholders can be used to refer to specific MAC addresses and are expanded by the AP when the filter is activated. Once expanded, the filter must respect the pcap syntax. The pcap syntax is documented in the tcpdump man page:

[http://www.tcpdump.org/tcpdump\\_man.html](http://www.tcpdump.org/tcpdump_man.html)

### Placeholders

- `%a` : MAC address of the controller.
- `%b` : MAC address of the bridge.
- `%g` : MAC address of the default gateway assigned to the AP.
- `%w` : MAC address of AP wireless port.

## Wireless mobility considerations

If you enable the wireless mobility feature (to support roaming across different subnets), configuration of the wireless security filters must respect the following guidelines so as not to interfere with roaming functionality.

- The **Restrict wireless traffic to: Access point default gateway** option is not supported.
- The **Restrict wireless traffic to: MAC** or **Custom** options can be used provided that they restrict traffic to destinations that are reachable from all subnets in the mobile domain.

## Wireless protection

Three types of wireless protection are offered: WPA, 802.1X, and WEP.

### WPA

This option enables support for users with WPA / WPA2 client software.

## Mode

Support is provided for:

- **WPA (TKIP):** (Not supported on the HP 560.) WPA with TKIP encryption. When you enable this option, the VSC can only support legacy a/b/g traffic. All 802.11n features on a radio are disabled for this VSC.
- **WPA2 (AES/CCMP):** WPA2 (802.11i) with AES/CCMP encryption.
- **WPA or WPA2:** Mixed mode supports both WPA (version 1) and WPA2 (version 2) at the same time. Some legacy WPA clients may not work if this mode is selected. This mode is slightly less secure than using **WPA2 (AES/CCMP)** option.

**Note:** On radios that have **Client restriction** set to **802.11n only** or **802.11ac only**, WPA2 is always used instead of WPA.

Authentication must occur via an external device (unless preshared keys are used). If **Use HP MSM controller** is enabled under **General**, this must be an HP MSM Controller, otherwise a third-party RADIUS server can be used.

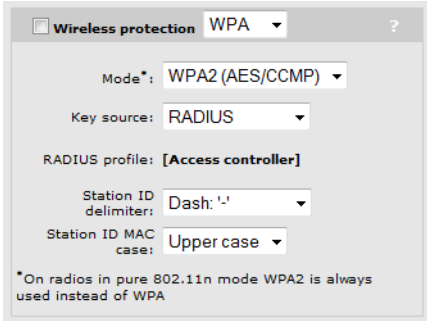
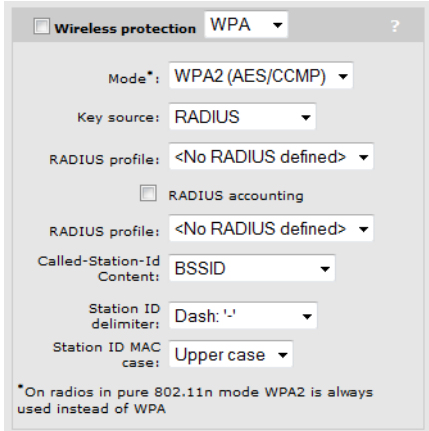
WPA options supported when the <i>Use HP MSM controller feature is ...</i>	
Enabled	Disabled
	

For a complete description of all options see the online help.

## 802.1X

This option enables support for users with 802.1X client software that use any of the following authentication methods: EAP-TLS, EAP-TTLS, and EAP-PEAP. Additionally, when an external RADIUS server is used, support for EAP-SIM, EAP-AKA, EAP-FAST, and EAP-GTC is also provided. Check your external RADIUS server for supported authentication methods.

Authentication must occur via an external device. If **Use HP MSM controller** is enabled (under **General**), this must be an HP MSM Controller. Otherwise a third-party RADIUS server can be used.

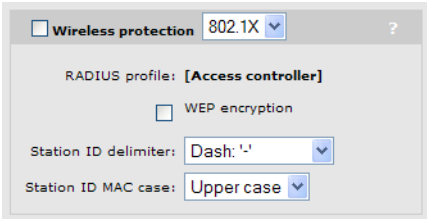
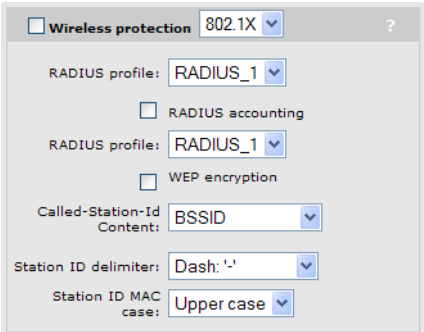
802.1X options supported when the <b>Use HP MSM controller</b> option is ...	
Enabled	Disabled
	

For a complete description of all options see the online help.

## WEP

This option provides support for users using WEP encryption.

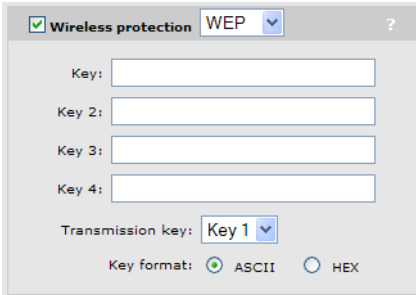

For a complete description of all options see the online help.

**NOTE:** When the radio used by a VSC is configured to support 802.11n, and the VSC is configured to use WEP, the VSC can only support legacy a/b/g traffic. (Except on the MSM422, where WEP is not supported when the radio is configured for 802.11n.)

## Protected Management Frames (802.11w)

*Only supported on the HP 560.*

Enable this option to provide enhanced security for WPA2 traffic by protecting unicast and multicast management action frames. This option is only configurable when **Wireless protection** is set to **WPA**, and **Mode** is set to an option that supports WPA2.

The **Terminate WPA at the controller** option is not compatible with this feature.

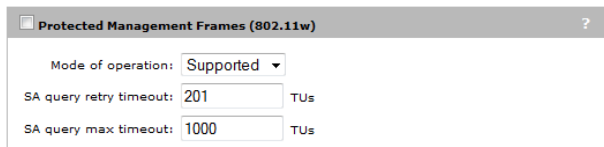

By default, WPA2 only protects data frames. 802.11w adds the following:

- Protects unicast management actions frames from eavesdropping and forging.
- Protects multicast management action frames from forging.
- **Mode of operation:** Select one of the following modes:
  - **Mandatory:** Only enable this option if all client stations support 802.11w.
  - **Supported:** Provides support for client stations that use 802.11w and those that do not. Clients that do not use 802.11w will continue to operate normally.
- **SA query retry timeout:** Specify the number of TUs (time units) that the AP waits when sending SA query requests. Requests are sent until a response is received from the client, or until the **SA query max timeout** is reached, in which case the client is disconnected.
- **SA query max timeout:** Specify the maximum number of TUs (time units) that can elapse before a client station must respond to the SA query requests sent by an AP. If a client station does not respond within this time, it is disconnected.

## MAC-based authentication

This option enables wireless users to be authenticated by their MAC addresses. Authentication must occur via an external device. If **Use HP MSM Controller** is enabled under **General**, this must be an HP MSM Controller. Otherwise a third-party RADIUS server can be used.

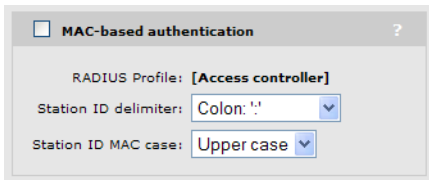
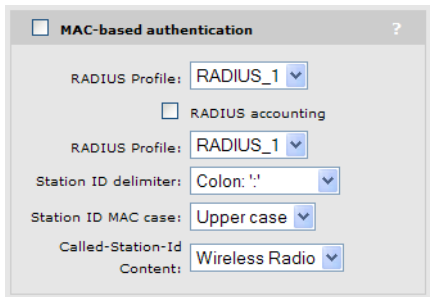
MAC-based authentication options supported when the <i>Use HP MSM Controller</i> option is ...	
Enabled	Disabled
	

For a complete description of all options, see the online help.

## Location-aware

This feature enables you to control logins to the public access network based on the AP, or group of APs, to which a user is connected. It is only available when **Use HP MSM controller** is enabled under **General**.

For each user login, location-aware sends the PHY Type, SSID, and VLAN to the controller. It also includes the specified **Group name**.

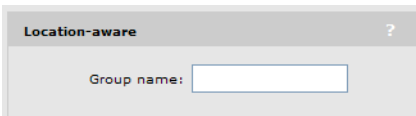

## MAC filter

When enabled, this option enables you to control access to the AP based on the MAC address of client stations. You can either block access or allow access, depending on your requirements. Select the MAC address list to use. Each list can contain up to 256 MAC addresses.

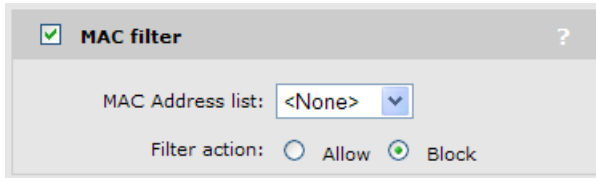

MAC filter configuration dialog showing the MAC Address list set to <None> and the Filter action set to Block.

To define a MAC address list, see [“Configuring MAC address lists” \(page 107\)](#).

The following table describes how the MAC filter functions when it is used alone and in combination with other authentication options:

Client address	Filter action	When used alone	When used with MAC-based authentication	When used with 802.1X authentication
Client address is in the MAC address list.	Allow	Access is granted.	Access is granted. MAC-based authentication is not performed.	Access is granted or denied based on result of 802.1X authentication.
Client address is in the MAC address list.	Block	Access is denied.	Access is denied. MAC-based authentication is not performed.	Access is denied.
Client address is <b>not</b> in the MAC address list.	Allow	Access is denied.	Access is granted or denied based on result of MAC-based authentication. (Not supported on access-controlled VSCs.)	Access is granted or denied based on result of 802.1X authentication.
Client address is <b>not</b> in the MAC address list.	Block	Access is granted.	Access is granted or denied based on result of MAC-based authentication.	Access is granted or denied based on result of 802.1X authentication.

## IP filter

When this option is enabled, the VSC only allows wireless traffic that is addressed to an IP address that is defined in the list. All other traffic is blocked, except for:

- DNS queries (i.e., TCP/UDP traffic on port 53)
- DHCP requests/responses

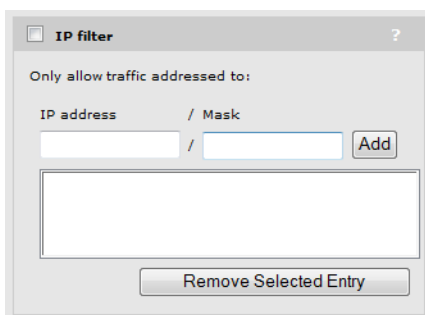

IP filter configuration dialog showing the IP filter checkbox unchecked and the IP address and Mask input fields.

A maximum of two addresses can be defined. Each address can target a specific device or a range of addresses.

## Examples

To only allow traffic addressed to a gateway at the address 192.168.130.1, define the filter as follows:

- Address = 192.168.130.1
- Mask = 255.255.255.255

To only allow traffic addressed to the network 192.168.130.0, define the filter as follows:

- Address = 192.168.130.0
- Mask = 255.255.255.0

## VSC data flow

### Stand-alone deployment

#### VSC on autonomous AP

##### Ingress

The AP only handles wireless traffic. The SSID is the name of the wireless network with which the user associates.

##### Features

- **Authentication:** Authentication can be either 802.1X or MAC. To validate user credentials the AP makes use of an external RADIUS server, which can be the controller or a third-party device. For more information, see [“Stand-alone deployment” \(page 79\)](#).
- **Wireless security filters:** Enables the AP to block traffic unless it is addressed to a specific device (like the controller). For more information, see [“Wireless security filters” \(page 72\)](#).
- **MAC filter:** Enables the AP to only allow wireless-to-wired LAN traffic for specific wireless-user MAC addresses. For more information, see [“MAC filter” \(page 78\)](#).
- **IP filter:** Enables the AP to only allow wireless-to-wired LAN traffic for specific wireless-user IP addresses. For more information, see [“IP filter” \(page 78\)](#).

##### Egress

- **Bridge onto port 1+2:** Unless a centralized mode tunnel has been established, user and authentication traffic is bridged onto ports 1 and 2 (if available).
- **VLAN:** All traffic on port 1 or 2 (if available) can be assigned to a VLAN.

### AP deployed with a controller

#### Ingress

The AP only handles wireless traffic. The SSID is the name of the wireless network that the user associates with.

#### Features

- **Authentication:** Authentication can either 802.1X or MAC. To validate user credentials the AP makes use of the controller. For more information, see the chapter on *User authentication* in the *MSM7xx Controllers Configuration Guide*.
- **Wireless security filters:** Enables the AP to block traffic unless it is addressed to a specific device (like the controller). For more information, see [“Wireless security filters” \(page 72\)](#).

- **MAC filter:** Enables the AP to only allow wireless-to-wired LAN traffic for specific wireless-user MAC addresses. For more information, see [“MAC filter” \(page 78\)](#).
- **IP filter:** Enables the AP to only allow wireless-to-wired LAN traffic for specific wireless-user IP addresses. For more information, see [“IP filter” \(page 78\)](#).

## Egress

- **Bridge onto port 1+2:** User and authentication traffic is bridged onto ports 1 and 2 (if available).
- **VLAN:** All traffic on port 1 or 2 (if available) can be assigned to a VLAN.

## VSC on controller

For more information on controller configuration, see the *MSM7xx Controllers Configuration Guide*.

### Ingress

- **SSID (LAN port):** SSID is retrieved using the location-ware function client runs on AP.
- **VLAN (LAN or Internet port):** Traffic with a VLAN ID is handled by the VSC with a matching VLAN definition.
- **Untagged (LAN port):** Untagged traffic on the LAN port may originate from wired users, or APs operating in autonomous mode (HP or third-party).

### Features

- **Authentication:** The controller supports 802.1X, MAC, or HTML authentication. To validate user login credentials the controller can use the local user accounts or make use of a third-party authentication server (Active Directory or RADIUS).
- **Access control features:** The controller provides a number of features that can be applied to user sessions. Features can be enabled globally or on a per-account basis.

## Egress

The controller enables user traffic to be forwarded to different output interfaces, which include the routing table, VLAN ID, or IP GRE tunnel.

## Quality of service

QoS can be enabled on a VSC, see [“Quality of service” \(page 80\)](#), or on a local mesh link, see [“Quality of service” \(page 113\)](#).

The quality of service (QoS) setting (under Virtual AP in a VSC) provides a number of different mechanisms to prioritize wireless traffic sent to wireless client stations. This is useful when the AP handles wireless traffic from multiple devices (or multiple applications on a single device), that have different data flow requirements.

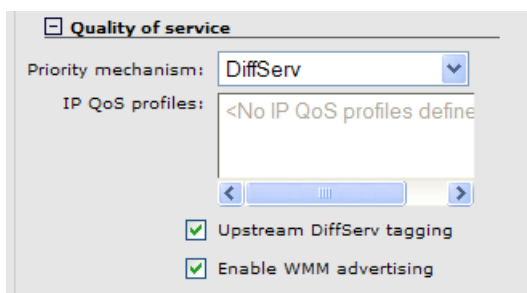



The QoS feature defines four traffic queues based on the Wi-Fi Multimedia (WMM) access categories. In order of priority, these queues are:

Queue	WMM access category	Typically used for
1	AC_VO	Voice traffic
2	AC_VI	Video traffic
3	AC_BE	Best effort data traffic
4	AC_BK	Background data traffic

Outgoing wireless traffic on the VSC is assigned to a queue based on the selected priority mechanism. Traffic delivery is based on strict priority (per the WMM standard). Therefore, if excessive traffic is present on queues 1 or 2, it will reduce the flow of traffic on queue 3 and queue 4.

Regardless of the priority mechanism that is selected:

- Traffic that cannot be classified by a priority mechanism is assigned to queue 3.
- SVP (SpectraLink Voice Protocol) traffic is always assigned to queue 1, except if you select the VSC-based priority mechanism, in which case SVP traffic is assigned to the configured queue.

## Priority mechanisms

Priority mechanisms are used to classify traffic on the VSC and assign it to the appropriate queue. The following mechanisms are available:

### 802.1p

This mechanism classifies traffic based on the value of the VLAN priority field present within the VLAN header.

Queue	802.1p (VLAN priority field value)
1	6, 7
2	4, 5
3	0, 3
4	1, 2

### VSC-based priority

This mechanism is unique to HP. It enables you to assign a single priority level to all traffic on a VSC. If you enable the VSC-based priority mechanism, it takes precedence regardless of the priority mechanism supported by associated client stations. For example, if you set VSC-based low priority, then all devices that connect to the VSC have their traffic set at this priority, including SVP clients.

Queue	VSC-based priority value
1	VSC-based Very High
2	VSC-based High
3	VSC-based Normal
4	VSC-based Low

## DiffServ (Differentiated Services)

This mechanism classifies traffic based on the value of the Differentiated Services (DS) codepoint field in IPv4 and IPv6 packet headers (as defined in RFC2474). The codepoint is composed of the six most significant bits of the DS field.

Queue	DiffServ (DS codepoint value)
1	111000 (Network control) 110000 (Internetwork control)
2	101000 (Critical) 100000 (Flash override)
3	011000 (Flash) 000000 (Routine)
4	010000 (Immediate) 001000 (Priority)

## TOS

This mechanism classifies traffic based on value of the TOS (Type of Service) field in an IP packet header.

Queue	TOS (Type of Service field value)
1	0x30, 0xE0, 0x88, 0xB8
2	0x28, 0xA0
3	0x08, 0x20
4	All other TOS traffic

## IP QoS

This option lets you assign traffic to the queues based on the criteria in one or more IP QoS profiles. Each profile lets you target traffic on specific ports or using specific protocols.

## Disabled

When QoS traffic prioritization is disabled, all traffic is sent to queue 3.

## IP QoS profiles

This option is only available if you set the **Priority mechanism** to **IP QoS**.

Select the IP QoS profiles to use for this profile. To add QoS profiles to the list, use the **Network > IP QoS** page.

Up to 10 profiles can be selected. To select more than one profile, hold down the CTRL key as you select profile names in the list.

To define an IP QoS profile, see [“Configuring IP QoS profiles” \(page 26\)](#).

## Upstream DiffServ tagging

Enable this option to have the AP apply differentiated services marking to upstream traffic.

Layer 3 upstream marking ensures end-to-end quality of service in your network. Data originating on the wireless network can now be carried throughout the network (wireless *and* wired) with a consistent quality of service and priority. This feature is enabled by default.

When this feature is enabled, packets received on the wireless interface that include Wi-Fi Multimedia (WMM) QoS values are remarked using IP DiffServ values when transmitted to the

wired network. (Remarking is only done for packets that have a DiffServ value of 0. The original DiffServ value from the wireless client is preserved for all other packets.)

## Upstream/downstream traffic marking

Depending on the priority mechanism that is active, upstream and downstream traffic is marked as described in this section.

### Upstream traffic marking

This table describes the marking applied to wireless traffic sent by connected client stations to an AP and then forwarded onto the wired network by the AP.

Mechanism	INCOMING TRAFFIC Wireless traffic sent from client stations to the AP	OUTGOING TRAFFIC Traffic sent by the AP to the network		
		L2 marking	L3 marking	
			Upstream DiffServ tagging is enabled	Upstream DiffServ tagging is disabled
802.1p	WMM	802.1p (Requires an egress VLAN to be defined for the VSC.) If L3 marking is enabled and the L3 marking value is higher than the L2 marking value, then the L3 marking value is used for L2 marking.	DiffServ (Remarking is only done for packets that have a DiffServ value of 0, otherwise the original value is preserved.)	Pass-through (Original layer 3 marking, if any, is preserved.)
DiffServ	DiffServ		Pass-through (Original layer 3 marking, if any, is preserved.)	
TOS	TOS		Pass-through (Original layer 3 marking, if any, is preserved.)	
VSC-based	WMM, Non-WMM		Uses the selected VSC-based value (very high, high, normal, low).	
IP QoS	WMM		Pass-through (Original layer 3 marking, if any, is preserved.)	

## Downstream traffic marking

This table describes the marking applied to traffic received from the wired network by an AP and then sent to connected wireless client stations.

Mechanism	INCOMING TRAFFIC Traffic received from wired network	OUTGOING TRAFFIC Wireless traffic sent from the AP to client stations	
		WMM Client	Non-WMM Client
802.1p	802.1p	WMM + HPQ (WMM marking done according to the rules for the mechanism.)	HPQ (hardware priority queueing)
DiffServ	DiffServ		
TOS	TOS		
VSC-based	All traffic on the VSC.		
IP QoS	All traffic that matches the ports/protocols specified in the selected IP QoS profiles.		

**NOTE:** Although the WMM specification refers to 802.1D and not 802.1p, this guide uses the term 802.1p because it is more widely recognized. (The updated IEEE 802.1D: ISO/IEC 15802-3 (MAC Bridges) standard covers all parts of the Traffic Class Expediting and Dynamic Multicast Filtering described in the IEEE 802.1p standard.)

## 6 Events

The events feature provides a logging system that can be used by administrators and support personnel to easily monitor and troubleshoot system issues.

**Note:** For backward compatibility, the system log feature that was available in previous releases is still available on the **Tools** menu.

An event is the occurrence of a condition that has been detected in the network infrastructure. For example, wireless client association/disassociation, radios turned on/off, radio power/channel changes and more. A record of events is typically stored over relatively long periods of time to assist with OAM&P and auditing activities.

A new Events page has been created on the Tools menu that replaces and enhances the old client event log. The following screen capture shows the Events page with a number of events.

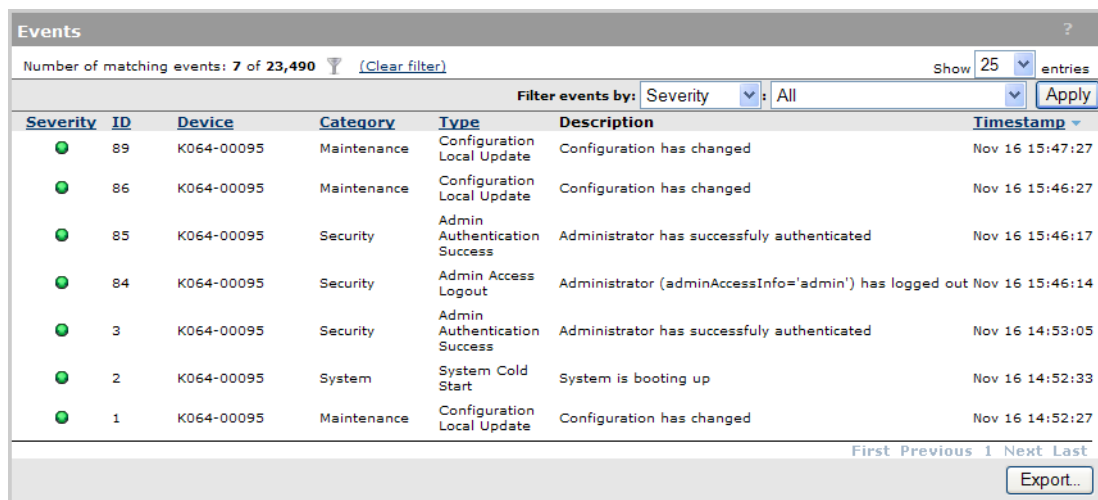

Severity	ID	Device	Category	Type	Description	Timestamp
●	89	K064-00095	Maintenance	Configuration Local Update	Configuration has changed	Nov 16 15:47:27
●	86	K064-00095	Maintenance	Configuration Local Update	Configuration has changed	Nov 16 15:46:27
●	85	K064-00095	Security	Admin Authentication Success	Administrator has successfully authenticated	Nov 16 15:46:17
●	84	K064-00095	Security	Admin Access Logout	Administrator (adminAccessInfo='admin') has logged out	Nov 16 15:46:14
●	3	K064-00095	Security	Admin Authentication Success	Administrator has successfully authenticated	Nov 16 14:53:05
●	2	K064-00095	System	System Cold Start	System is booting up	Nov 16 14:52:33
●	1	K064-00095	Maintenance	Configuration Local Update	Configuration has changed	Nov 16 14:52:27

The Severity, Device, Alarm, and Timestamp columns display detailed information if you hover the mouse pointer over an entry in the table as shown.

You can also sort events in any column (except Description) by clicking the column title.

### Filter events by

To see only a subset of all events, select a filter condition and click **Apply**. Filters are saved across sessions and can be cleared by selecting **Clear filters**. To see only a subset of all events, select a filter condition and click **Apply**.

Filters are saved across sessions and can be cleared by selecting **Clear filters**.

### Table

#### Severity

- **Critical (Red):** Events of this type indicate a failure and signal the need for immediate attention.
- **Major (Orange):** Events of this type indicate an impending failure.
- **Minor (Yellow):** Events of this type indicate a warning condition that can escalate into a more serious problem.
- **Informational (Green):** Events of this type require no action. They are provided for information purposes.

## ID

Unique number assigned to the event.

## Device

Indicates the device that detected the event. Hover the mouse pointer over the device name to see the device type and its MAC address.

## Category

Events are classified into categories so that they can be sorted. Categories include:

- 802.1X
- Controlled AP
- DHCP
- MAC Authentication
- Maintenance
- MTM
- Public Access
- REI
- RRM
- Satellite Management
- Security
- Syslog
- System
- Teamed Controller
- Teaming
- VPN
- VSC
- Wireless
- WPA

## Type

Classifies the event within a category. Categories are predefined and cannot be changed.

## Alarm

If an event triggers an alarm, the appropriate alarm indicator appears in this column. Hover the mouse pointer over the alarm to see its severity and ID. The association between an event and an alarm is predefined and is not configurable.

## Description

Detailed information about the event.

## Timestamp

Date and time that the event occurred.

## Button

## Export

Click this button to export all the events that are visible in the table to a CSV (comma-separated values) file for use in other applications.

## Configuring SNMP notifications for events

Notifications can be set via SNMP for specific events as follows:

1. Select **Management > SNMP**. The SNMP agent configuration page opens.

SNMP agent configuration

**Attributes**

System name: %serial\_number%

Location:

Contact:

Engine ID: 80:00:22:28:03:78:E3:85:8E:70:20

Port: 161 UDP

SNMP protocol:  version 1  version 2c  version 3

Notifications:  [Configure Notifications...](#)

**v1/v2c communities**

Community name: ..... Read-only name: .....

Confirm community name: ..... Confirm read-only name: .....

**v3 users**

Username	Security	Access level
<a href="#">readonly</a>	MD5/DES	read-only
<a href="#">readwrite</a>	MD5/DES	read-write

[Add New User...](#)

**Notification receivers**

Host	UDP port	Version	Community/Username
No notifications receivers are defined.			

[Add New Receiver...](#)

2. Select the **SNMP agent configuration** checkbox.
3. Under **Attributes**, select the **Notifications** checkbox.
4. Select **Configure Notifications**. The SNMP notification configuration page opens.

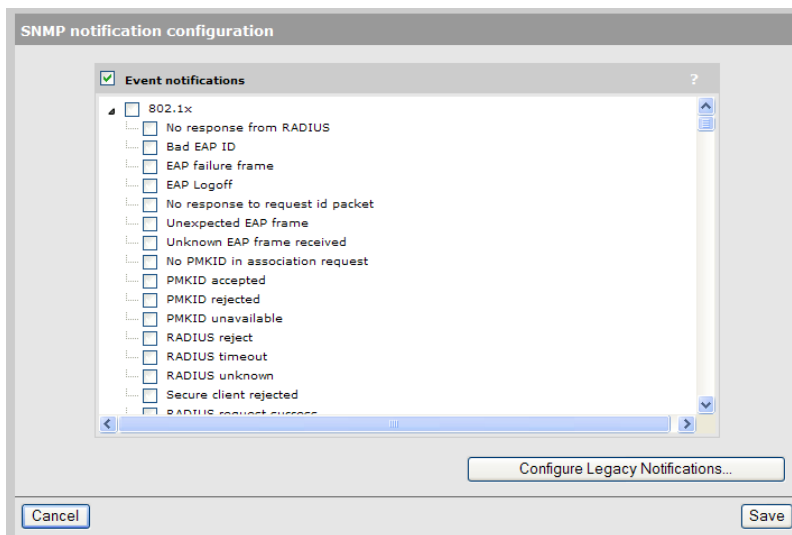

5. Enable **Event notifications** and select the notifications that you want to send.
6. Select **Save**. You are returned to the SNMP agent configuration page.
7. In the **Notifications receivers** box, select **Add New Receiver**. The Add/Edit SNMP notifications receiver page opens.

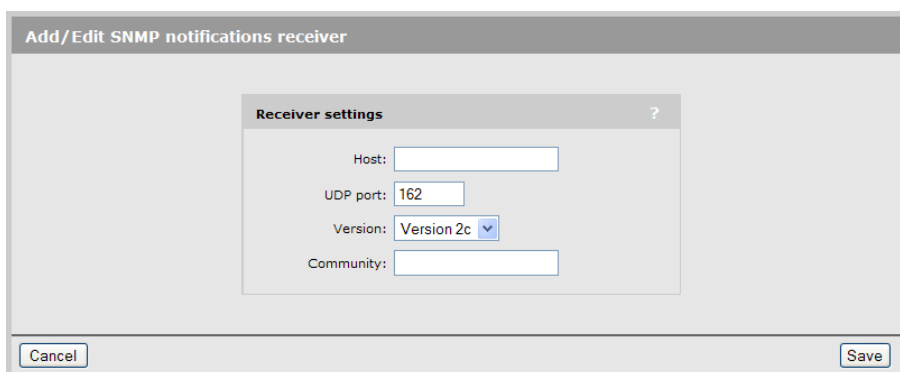

8. Define the settings for the receiver as follows:
  - **Host:** Specify the domain name or IP address of the SNMP notifications receiver to which the controller will send notifications.
  - **UDP port:** Specify the port on which notifications will be sent.
  - **SNMP version:** Select the SNMP version (v1, v2c, v3) for this receiver.
  - **Community:** For SNMP v1 and v2c, specify the SNMP community name of the receiver. For SNMP v3, select the SNMP v3 username of the receiver.
9. Select **Save**.



## 7 Working with VLANs

The AP provides a robust and flexible virtual local area network (VLAN) implementation that supports a wide variety of scenarios.

For example, VLANs can be used to isolate management from user traffic, or to route traffic over a local mesh connection.

You can map user traffic to a VLAN for each virtual service community (VSC) or on a per-user basis by setting the appropriate RADIUS attributes in a users account.

Up to 80 VLAN definitions can be created. VLAN ranges are supported enabling a single definition to span a range of VLAN IDs.

The following AP features can be supported on a VLAN:

- Management tool access
- SNMP access
- SOAP access

### Defining a VLAN on a port

Define a VLAN on AP port as follows:

1. Define a network profile with the required VLAN as described under [“To define a new network profile”](#) (page 14). This example uses a new network profile called Guest, assigned to VLAN 100.
2. Select **Network > VLANs**.

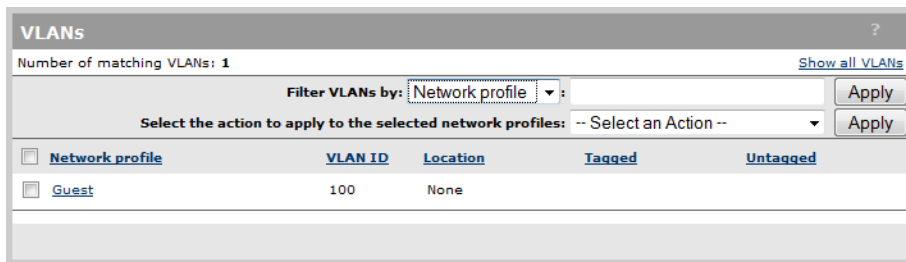

3. Select the network profile you defined in step 1 (Guest). This opens the Add/Edit VLAN mapping page.

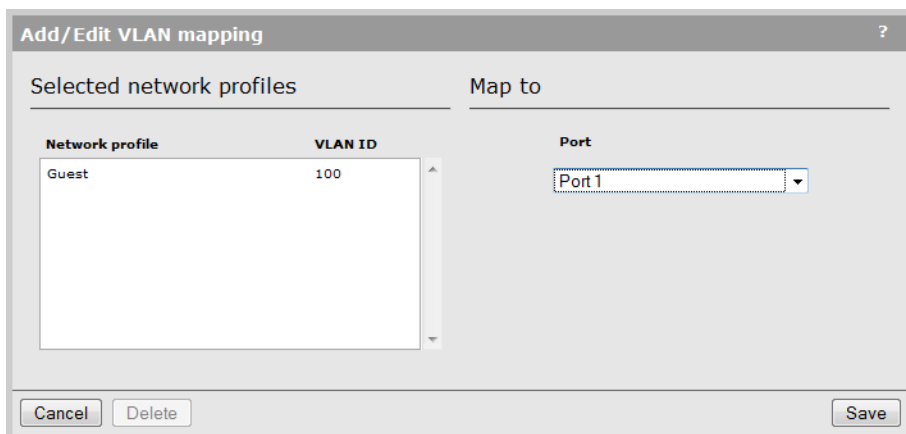

4. Under **Map to**, select the port to which the VLAN will be bound.
5. Select **Save**.

## Defining an egress VLAN for a VSC

You can map egress traffic on each VSC to its own VLAN. Wireless clients that connect to a VSC with VLAN support are bridged to the appropriate VLAN. Address allocation and security measures are the responsibility of the target network to which the VLAN connects.

**NOTE:** You cannot assign the same VLAN ID to the default VLAN and to a VLAN that is mapped to a VSC egress.

1. Select **Network > VSC**. Select an existing VSC to edit it or select **Add New VSC Profile**.
2. Under **Egress VLAN**, select a **VLAN ID**. To be included in the drop-down list, the VLAN must be mapped to a port on the **Network > VLANs** page and not be assigned to a VLAN range.



3. Select **Save**.

## Configuring a default VLAN

You can configure port 1 (or port 2) with a default VLAN setting so that any outgoing traffic that is not tagged with a VLAN ID receives the default VLAN ID.

To configure a default VLAN, do the following:

1. Select **Network > Ports**. Select Port 1 or Port 2 if available. This displays the Port configuration page.

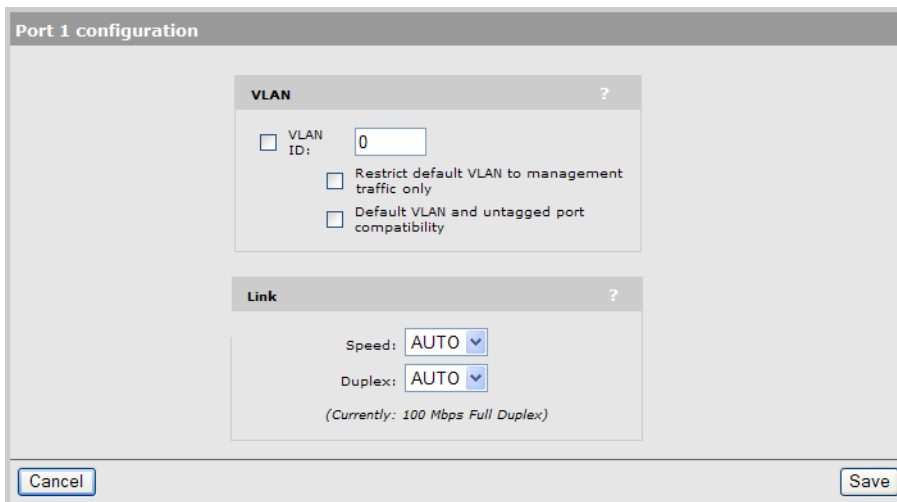

2. Under **VLAN**, configure the following settings:
  - Enable the **VLAN ID** check box and specify a VLAN number.
  - If required, enabled the **Restrict default VLAN to management traffic only** check box. This restricts the default VLAN to carry management traffic only, which includes the following:
    - All traffic that is exchanged with the controller (login authentication requests/replies.
    - All traffic that is exchanged with external RADIUS servers.
    - HTTPS sessions established by managers and operators of the management tool.

- Incoming and outgoing SNMP traffic.
  - DNS requests and replies.
  - If required, enable the **Default VLAN and untagged port compatibility** check box. This causes any traffic sent on the default VLAN to also be sent untagged on the port:
3. Select **Save**.

## Assigning VLANs to individual users

You can assign a VLAN to an individual user by setting the attributes **Tunnel-Medium-Type**, **Tunnel-Private-Group-ID**, and **Tunnel-Type** in the users RADIUS account. Restrictions are as follows:

- A user cannot be assigned to a VLAN that is set as the default VLAN on port 1 or port 2.
- A user can only be assigned to a VLAN that is defined on the **Network > Ports** page.
- Only applicable to clients using WPA or 802.1X. (Not applicable to MAC authentication.)

---

**NOTE:** A VLAN that is assigned to a user overrides a VLAN assigned by a VSC or by the default VLAN.

---

## VLAN bridging

If you assign a VLAN ID to more than one interface, the VLAN is bridged across the interfaces.

For example, if you create the VLANs shown in the following table, all VLAN traffic with ID 50 is bridged across all three interfaces. If you create a VSC and assign the egress VLAN to any of these VLANs, output from the VSC can be sent to any interface.

VLAN name	VLAN ID	Assigned to
Bridge_1	50	Port 1
Bridge_2	50	Port 2
Bridge_3	50	Local mesh 1

# 8 Authentication services

## Using a third-party RADIUS server

The AP can use one or more external RADIUS servers to perform a number of authentication and configuration tasks, including the tasks shown in the table below.

Task	For more information see
Validating administrator login credentials.	"Authenticating manager logins using a third-party RADIUS server" (page 94).
Validating user login credentials for WPA, 802.1X, or MAC-based authentication types on non-access-controlled VSCs.	"Wireless protection" (page 74). "MAC-based authentication" (page 77).
Retrieving RADIUS attributes on a per-user basis on non-access-controlled VSCs.	"Configuring user accounts on a RADIUS server" (page 95).
Storing accounting information for each user on non-access-controlled VSCs.	Accounting support is enabled under "Wireless protection" (page 74) or "MAC-based authentication" (page 77).

### NOTE:

- On VSCs that have the **Use HP MSM controller** option enabled (creating an access-controlled VSC), see the *MSM7xx Controllers Configuration Guide* for details on how user authentication is configured.
- When a VSC has the **Use HP MSM controller** option disabled (creating a non-access-controlled VSC), an external RADIUS server can be used to validate user credentials for WPA, 802.1X, or MAC-based authentication as described in this section.

## Configuring a RADIUS server profile

The AP enables you to define up to 64 RADIUS profiles (depending on the license that is installed). Each profile defines the settings for a RADIUS client connection. To support a client connection, you must create a client account on the RADIUS server. The settings for this account must match the profile settings you define on the AP.

For backup redundancy, each profile supports a primary and secondary server.

The AP can function with any RADIUS server that supports RFC 2865 and RFC 2866. Authentication occurs via authentication types such as: EAP-MD5, CHAP, MSCHAP v1/v2, PAP, EAP-TLS, EAP-TTLS, EAP-PEAP, EAP-SIM, EAP-AKA, EAP-FAST, and EAP-GTC. (EAP-MD5 is not supported on VSCs that have WEP with dynamic keys enabled.)

**NOTE:** If you change a RADIUS profile to connect to a different server while users are active, all RADIUS traffic for active user sessions is immediately sent to the new server.

## Configuration procedure

1. Select **Authentication > RADIUS profiles**. The RADIUS profiles page opens.

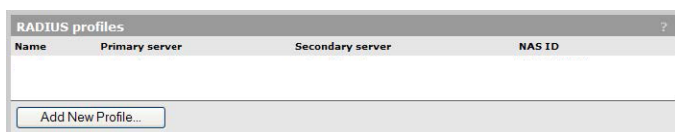

2. Select **Add New Profile**. The Add/Edit RADIUS Profile page opens.

3. Configure the profile settings as described in the following section.
4. Select **Save**.

## Configuration parameters

### Profile name

Specify a name to identify the profile.

### Settings

#### Authentication port:

Specify a port on the RADIUS server to use for authentication. By default RADIUS servers use port 1812.

#### Accounting port

Specify a port on the RADIUS server to use for accounting. By default RADIUS servers use port 1813.

#### Retry interval

Specify the number of seconds that the AP waits before access and accounting requests time out. If the AP does not receive a reply within this interval, the AP switches between the primary and secondary RADIUS servers, if a secondary server is defined. A reply that is received after the retry interval expires is ignored.

Retry interval applies to access and accounting requests that are generated by the following:

- Manager or operator access to the management tool
- User authentication by way of HTML
- MAC-based authentication of devices
- Authentication of the AP
- Authentication of the controlled AP

You can determine the maximum number of retries as follows:

- HTML-based logins: Calculate the number of retries by taking the setting for the HTML-based logins **Authentication Timeout** parameter and dividing it by the value of this parameter. Default settings result in 4 retries (40 / 10).
- MAC-based and AP authentication: Number of retries is infinite.
- 802.1X authentication: Retries are controlled by the 802.1X client software.

### Authentication method

Select the default authentication method that the AP uses when exchanging authentication packets with the RADIUS server defined for this profile. For 802.1X users, the authentication method is always determined by the 802.1X client software and is not controlled by this setting. If traffic between the AP and the RADIUS server is not protected by a VPN, HP recommends that you use either EAP-MD5 or MSCHAP V2 (if supported by your RADIUS server). PAP and MSCHAP V1 are less secure protocols. (EAP-MD5 is not supported on VSCs that have WEP with dynamic keys enabled.)

### NAS ID

Specify the identifier for the network access server that you want to use for the AP. By default the serial number of the AP is used. The AP includes the NAS-ID attribute in all packets that it sends to the RADIUS server.

### Always try primary server first

Enable this option if you want to force the AP to contact the primary server first.

Otherwise, the AP sends the first RADIUS access request to the last known RADIUS server that replied to any previous RADIUS access request. If the request times out, the next request is sent to the other RADIUS server if defined.

For example, assume that the primary RADIUS server was not reachable and that the secondary server responded to the last RADIUS access request. When a new authentication request is received, the AP sends the first RADIUS access request to the secondary RADIUS server.

If the secondary RADIUS server does not reply, the AP retransmits the RADIUS access request to the primary RADIUS server. When two servers are configured, the AP always alternates between the two.

### Use message authenticator

When enabled, causes the RADIUS Message-Authenticator attribute to be included in all RADIUS access requests sent by the AP.

---

**NOTE:** This option has no effect on IEEE802dot1x authentication requests. These requests always include the RADIUS Message-Authenticator attribute.

---

### Primary/Secondary RADIUS server

#### Server address

Specify the IP address or fully-qualified domain name of the RADIUS server.

#### Secret/Confirm secret

Specify the password for the AP to use to communicate with the RADIUS server. The shared secret is used to authenticate all packets exchanged with the server, proving that the packets originate from a valid/trusted source.

### Authentication realms

## Authenticating manager logins using a third-party RADIUS server

Using a RADIUS server enables you to have multiple manager accounts, each with a unique login name and password. Identify manager accounts using the vendor specific attribute **web-administrative-role**. Valid values for this attribute are **Manager** and **Operator**. For attribute

information, see [“Configuring administrative accounts on a RADIUS server” \(page 100\)](#). To use a RADIUS server, you must define a RADIUS profile on the **Authentication > RADIUS profiles** page.

**NOTE:** Login credentials for managers can be verified using local account settings and/or an third-party RADIUS sever. If both options are enabled, the RADIUS server is always checked first.

Configure RADIUS authentication as follows:

1. Define an account for the administrator on the RADIUS server. See [“Configuring administrative accounts on a RADIUS server” \(page 100\)](#).
2. On the controller, create a RADIUS profile that will connect the controller to the RADIUS server. See [“Configuring a RADIUS server profile” \(page 92\)](#).
3. Select **Management > Management tool**.
4. Under **Administrator authentication**, set **Authenticate via** to the RADIUS profile you created. In this example, the profile is called **RAD1**.

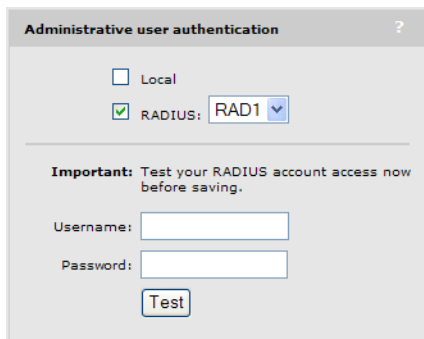

5. Test the RADIUS account to make sure it is working before you save your changes. Specify the appropriate username and password and select **Test**.  
(As a backup measure you can choose to enable **Local**. This will allow you to log in using the local account if the connection to the RADIUS server is unavailable.)

## Configuring user accounts on a RADIUS server

When a non-access-controlled VSC is set to use WPA, 802.1X, or MAC-based authentication, a RADIUS server must be used to authenticate user logins. You must create an account for each user on the RADIUS sever with the appropriate username and password.

The AP provides support for a number of standard RADIUS user attributes, including those for authentication and accounting. Refer to your RADIUS documentation for more information on how to use these attributes.

### Access Request attributes

This table lists all attributes supported in Access Request packets for each authentication type.

Attribute	Admin login	802.1X	MAC	Format
Acct-Session-Id	×	✓	✓	32-bit unsigned integer
Called-Station-Id	×	✓	✓	Called-Station-Id
Calling-Station-Id	×	✓	✓	Calling-Station-Id
EAP-Message	✓	✓	×	EAP-Message
Framed-MTU	✓	✓	×	Framed-MTU
Message-Authenticator	✓	✓	✓	Message-Authenticator
NAS-Identifier	✓	✓	✓	NAS-Identifier

Attribute	Admin login	802.1X	MAC	Format
NAS-Ip-Address	×	✓	✓	NAS-Ip-Address
NAS-Port	✓	✓	✓	NAS-Port
NAS-Port-Type	✓	✓	✓	NAS-Port-Type
Service-Type	✓	✓	✓	Service-Type
State	✓	✓	×	State
User-Name	✓	✓	✓	User-Name
User-Password	×	×	✓	User-Password
Vendor-specific (Colubris)SSID	×	×	✓	Colubris-AVPair (SSID)

## Descriptions

- **Acct-Session-Id** (32-bit unsigned integer): A unique accounting ID used to make it easy to match up records in a log file.
- **Called-Station-Id** (string): BSSID of the VSC used by a wireless client, or the MAC address of the LAN port used by a wired client. By default, the MAC address is sent in IEEE format. For example: 00-02-03-5E-32-1A. The format can be changed under **Wireless protection** on the **VSC > Profiles** page.
- **Calling-Station-Id** (string): The MAC address of the 802.1X client station. By default, the MAC address is sent in IEEE format. For example: 00-02-03-5E-32-1A. The format can be changed under **Wireless protection** on the **VSC > Profiles** page.
- **Framed-MTU** (32-bit unsigned integer): Hard-coded value of 1496.
- **Message-Authenticator** (string): As defined in RFC 2869. Always present even when not doing an EAP authentication. Length = 16 bytes.
- **NAS-Identifier** (string): The NAS ID set on the **Security > RADIUS** page for the RADIUS profile being used.
- **NAS-Ip-Address** (32-bit unsigned integer): The IP address of the port the AP is using to communicate with the RADIUS server.
- **NAS-Port** (32-bit unsigned integer): A virtual port number starting at 1. Assigned by the AP.
- **NAS-Port-Type** (32-bit unsigned integer): Always set to 19, which represents WIRELESS\_802\_11.
- **Service-Type** (32-bit unsigned integer): Set to LOGIN\_USER.
- **State** (string): As defined in RFC 2865.
- **User-Name** (string): The username assigned to the user. Or if MAC-authentication is enabled, the MAC address of the wireless client station.

The following attributes are mutually exclusive depending on the RADIUS authentication method.

- **User-Password** (string): The password supplied by a user or device when logging in. Encoded as defined in RFC 2865. Only present when the authentication method for the RADIUS profile



is set to PAP. Or, if MAC-authentication is enabled, this attribute contains the MAC address of the wireless client station.

- **EAP-Message** (string): As defined in RFC 2869. Only present when the authentication method for the RADIUS profile is set to EAP-MD5.
- **Vendor-specific (Colubris-AVPair SSID)**: SSID that the customer is associated with.  
The Colubris-AVPair attribute conforms to RADIUS RFC 2865. You may need to define this attribute on your RADIUS server (if it is not already present) using the following values:
  - SMI network management private enterprise code = 8744
  - Vendor-specific attribute type number = 0
  - Attribute type: A string in the following format `<keyword>=<value>`

## Access Accept attributes

This table lists all attributes supported in Access Accept packets for each authentication type.

Attribute	Admin login	802.1X	MAC
Acct-Interim-Interval	×	✓	✓
Class	×	✓	✓
EAP-Message	✓	✓	×
Idle-Timeout	×	✓	×
MS-MPPE-Recv-Key	×	✓	×
MS-MPPE-Send-Key	×	✓	×
Session-Timeout	×	✓	✓
Termination-Action	×	✓	✓
Tunnel-Medium-Type	×	✓	×
Tunnel-Private-Group-ID	×	✓	×
Tunnel-Type	×	✓	×
Vendor-specific (Microsoft)			
MS-MPPE-Recv-Key	×	✓	×
MS-MPPE-Send-Key	×	✓	×

## Descriptions

- **Acct-Interim-Interval** (32-bit unsigned integer): When present, enables the transmission of RADIUS accounting requests of the **Interim Update** type. Specify the number of seconds between each transmission.
- **Class** (string): As defined in RFC 2865.
- **EAP-Message** (string): Note that the content will not be read as the RADIUS Access Accept overrides whatever indication is contained inside this packet.
- **Idle-Timeout** (32-bit unsigned integer): Maximum idle time in seconds allowed for the user. Once reached, the user session is terminated with termination-cause IDLE-TIMEOUT. Omitting the attribute or specifying 0 disables the feature.

- **Session-Timeout** (32-bit unsigned integer): Maximum time a session can be active. After this interval:
  - 802.1X clients are automatically re-authenticated.
  - MAC clients are blocked and must de-associate and then re-associate to start a new MAC authentication cycle.
- **Termination-Action**: As defined by RFC 2865. If set to 1:
  - Customer traffic is not allowed during the 802.1X re-authentication.
  - When receiving traffic from a MAC client, the AP starts a new authentication cycle automatically and the client does not need to re-associate.
- **Tunnel-Medium-Type**: Used only when assigning a specific VLAN number to a customer. In this case it must be set to 802.
- **Tunnel-Private-Group-ID**: Used only when assigning a specific VLAN number to a customer. In this case it must be set to the VLAN ID.
- **Tunnel-Type**: Used only when assigning a specific VLAN number to a customer. In this case it must be set to VLAN.
- **Vendor-specific (Microsoft)**
  - **MS-MPPE-Recv-Key**: As defined by RFC 3078.
  - **MS-MPPE-Send-Key**: As defined by RFC 3078.

### Access Reject attributes

Access Reject RADIUS attributes are not supported.

### Access Challenge attributes

This table lists all attributes supported in Access Challenge packets for each authentication type.

Attribute	Admin login	802.1X	MAC
EAP-Message	×	✓	×
Message-Authenticator	×	✓	×
State	×	✓	×

### Descriptions

- **EAP-Message** (string): As defined in RFC 2869.
- **Message-Authenticator** (string): As defined in RFC 2869. Always present even when not doing an EAP authentication. length = 16 bytes.
- **State** (string): As defined in RFC 2865.

### Accounting Request attributes

This table lists all attributes supported in Accounting Request packets for each authentication type.

Attribute	802.1X	MAC
Acct-Input-Gigawords	✓	×
Acct-Input-Octets	✓	×
Acct-Input-Packets	✓	×

Attribute	802.1X	MAC
Acct-Output-Gigawords	✓	×
Acct-Output-Octets	✓	×
Acct-Output-Packets	✓	×
Acct-Session-Id	✓	✓
Acct-Session-Time	✓	✓
Acct-Status-Type	✓	✓
Acct-Terminate-Cause	✓	×
Called-Station-Id	✓	✓
Calling-Station-Id	✓	✓
Class	✓	✓
Framed-IP-Address	✓	×
Framed-MTU	✓	×
NAS-Identifier	✓	✓
NAS-Port	✓	✓
NAS-Port-Type	✓	✓
User-Name	✓	✓
Vendor-specific (HP/Colubris)SSID	✓	✓

## Descriptions

- **Acct-Input-Gigawords** (32-bit unsigned integer): High 32-bit value of the number of octets/bytes received by the user. Only present when Acct-Status-Type is Interim-Update or Stop.
- **Acct-Input-Octets** (32-bit unsigned integer): Low 32-bit value of the number of octets/ bytes received by the user. Only present when Acct-Status-Type is Interim-Update or Stop.
- **Acct-Input-Packets** (32-bit unsigned integer): Number of packets received by the user. Only present when Acct-Status-Type is Interim-Update or Stop.
- **Acct-Output-Gigawords** (32-bit unsigned integer): High 32-bit value of the number of octets/bytes sent by the user. Only present when Acct-Status-Type is Interim-Update or Stop. As defined in 2869.
- **Acct-Output-Octets** (32-bit unsigned integer): Low 32-bit value of the number of octets/bytes sent by the user. Only present when Acct-Status-Type is Interim-Update or Stop.  
**Acct-Output-Packets** (32-bit unsigned integer): Number of packets sent by the user. Only present when Acct-Status-Type is Interim-Update or Stop.
- **Acct-Session-Id** (32-bit unsigned integer): Random value generated by the AP.
- **Acct-Session-Time** (32-bit unsigned integer): Number of seconds since this session was authenticated.
- **Acct-Status-Type** (32-bit unsigned integer): Supported values are Accounting-Start (1), Accounting-Stop (2), and Accounting-On (7) and Accounting-Off (8).  
**Acct-Terminate-Cause** (32-bit unsigned integer): Termination cause for the session. Only present when Acct-Status-Type is Stop. Supported causes are: Idle-Timeout, Lost-Carrier, Session-Timeout, and User-Request. See RFC 2866 for details.

- **Called-Station-Id** (string):
  - **802.1X**: BSSID of the VSC. By default, the value address is sent in IEEE format. For example: 00-02-03-5E-32-1A. The format can be changed in the **Wireless protection** section of the **VSC > Profiles** page.
  - **MAC**: MAC Address of the radio (**Network > Ports** page). By default, the MAC address is sent in IEEE format. For example: 00-02-03-5E-32-1A. The format can be changed in the **Wireless protection** section of the **VSC > Profiles** page.
- **Calling-Station-Id** (string): The MAC address of the wireless client station in IEEE format. By default, the MAC address is sent in IEEE format. For example: 00-02-03-5E-32-1A. The format can be changed in the **Wireless protection** section of the **VSC > Profiles** page.
- **Class** (string): As defined in RFC 2865. Multiple instances are supported.
- **Framed-IP-Address** (32-bit unsigned integer): IP Address as configured on the client station (if known by the AP).
- **Framed-MTU** (32-bit unsigned integer): Hard-coded value of 1496. The value is always four bytes lower than the wireless MTU maximum which is 1500 bytes in order to support IEEE802.1X authentication.
- **NAS-Identifier** (string): The NAS ID set on the **Security > RADIUS** page for the profile being used.
- **NAS-Port** (32-bit unsigned integer): A virtual port number starting at 1. Assigned by the AP.
- **NAS-Port-Type** (32-bit unsigned integer): Always set to 19, which represents WIRELESS\_802\_11.
- **User-Name** (string): The RADIUS username provided by the 802.1X client.
- **Vendor-specific (Colubris-AVPair SSID)**: SSID that the customer is associated with. The HP Colubris-AVPair attribute conforms to RADIUS RFC 2865. You may need to define this attribute on your RADIUS server (if it is not already present) using the following values:
  - SMI network management private enterprise code = 8744
  - Vendor-specific attribute type number = 0
  - Attribute type: A string in the following format `<keyword>=<value>`

## Configuring administrative accounts on a RADIUS server

This section presents all RADIUS attributes that are supported for administrator (manager/operator) accounts.

---

**NOTE:** Only Access Request packets are supported for administrative accounts. Access Accept, Access Reject, Access Challenge, Accounting Request, and Accounting Response requests are not supported.

---

### Access Request attributes

The following are supported Access Request RADIUS attributes.

- **User-Name** (string): The username assigned to the user or a device when using MAC authentication.
- **NAS-Identifier** (string): The NAS ID set on the **Security > RADIUS** page for the profile being used.

- **Service-Type** (32-bit unsigned integer): As defined in RFC 2865. Set as follows:
  - Web Admin is SERVICE\_TYPE\_ADMINISTRATIVE
- **Framed-MTU** (32-bit unsigned integer): Hard-coded value of 1496.
- **MSCHAP-Challenge** (string): As defined in RFC 2433. Only present when the authentication scheme on the **Security > RADIUS** page is set to MSCHAPv1 or MSCHAPv2. Length = 8 bytes.
- **MSCHAP-Response** (string): As defined in RFC 2433. Only present when the authentication scheme on the **Security > RADIUS** page is set to MSCHAPv1. Length = 49 bytes.
- **Vendor-specific (Colubris-AVPair Administrative role)**: Administrative role assigned to the user, either manager or operator.

The Colubris-AVPair attribute conforms to RADIUS RFC 2865. You may need to define this attribute on your RADIUS server (if it is not already present) using the following values:

- SMI network management private enterprise code = 8744
- Vendor-specific attribute type number = 0
- Attribute type: A string in the following format `<keyword>=<value>`

The following keyword and value is supported for administrative accounts:

`web-administrative-role=role`

Where:

Parameter	Description
<code>role</code>	Use one of the following values to identify the role of the account: <ul style="list-style-type: none"> <li>◦ <b>Manager</b>: A manager is able to access all configuration pages and can change and save all configuration settings.</li> <li>◦ <b>Operator</b>: An operator is able to view all configuration pages, but is limited in the types of changes that can be made.</li> </ul>

# 9 Security

## Managing certificates

Digital certificates are electronic documents that are used to validate the end parties or entities involved in data transfer. These certificates are normally associated with X.509 public key certificates and are used to bind a public key to a recognized party for a specific time period.

The certificate stores provide a repository for managing all certificates. To view the certificate stores, select **Security > Certificate stores**.

The screenshot displays two sections of the certificate management interface:

- Trusted CA certificate store:** A table with columns: ID, Issued to, Current usage, Start date, Expiration date, CRL, and Delete. It lists two entries: 1. SOAP API Certificate Authority (issued to SOAP Server, start 2005-04-06, expires 2025-04-01) and 2. Management Console Dummy Authority (issued to HP Management console, start 2010-05-19, expires 2020-05-16). Below the table is a form to add a new certificate: "PKCS #7 file or X.509 certificate:" with a "Browse..." button and an "Install" button.
- Certificate and private key store:** A table with columns: ID, Issued to, Issued by, Current usage, Start date, Expiration date, and Delete. It lists two entries: 1. wireless.hp.internal (issued by wireless.hp.internal, used by Web Management Tool, SOAP Server, start 2010-11-03, expires 2038-10-27) and 2. Management Console Default client certificate (issued by Management Console Dummy Authority, used by HP Management console, start 2010-05-19, expires 2020-05-16). Below the table is a form to add a new certificate: "PKCS #12 file:" with a "Browse..." button, "PKCS #12 password:" with an "Install" button.

### Trusted CA certificate store

This list displays all root CA (certificate authority) certificates installed on the AP. The AP uses these CA certificates to validate the certificates supplied by peers during authentication. Multiple CA certificates can be installed to support validation of clients with certificates issued by different CAs.

The AP uses these certificates to validate certificates supplied by:

- Managers or operators accessing the AP's management tool.
- SOAP clients communicating with the AP's SOAP server.

The following information is presented for each certificate in the list:

- **Status light:** Indicates the certificate state.
  - **Green:** Certificate is valid.
  - **Yellow:** Certificate will expire soon.
  - **Red:** Certificate has expired.
- **ID:** A sequentially assigned number to help identify certificates with the same common name.
- **Issued to:** Name of the certificate holder. Select the name to view the contents of the certificate.
- **Issued by:** Name of the CA that issued the certificate.
- **Current usage:** Lists the services that are currently using this certificate.
- **Start/Expiration date:** Indicates the period during which the certificate is valid.
- **CRL:** Indicates if a certificate revocation list is bound to the certificate. An X.509 certificate revocation list is a document produced by a certificate authority (CA) that provides a list of serial numbers of certificate that have been signed by the CA but that should be rejected.
- **Delete:** Select to remove the certificate from the certificate store.

## Installing a new CA certificate

1. Specify the name of the certificate file or select **Browse** to choose from a list. CA certificates must be in X.509 or PKCS #7 format.
2. Select **Install** to install a new CA certificate.

## CA certificate import formats

The import mechanism supports importing the ASN.1 DER encoded X.509 certificate directly or as part of two other formats:

- PKCS #7 (widely used by Microsoft products)
- PEM, defined by OpenSSL (popular in the Unix world)
- The CRL can be imported as an ASN.1 DER encoded X.509 certificate revocation list directly or as part of a PEM file.

Content and file format	Items carried in the file	Description
ASN.1 DER encoded X.509 certificate	One X.509 certificate	This is the most basic format supported, the certificate without any envelope.
X.509 certificate in PKCS #7 file	One X.509 certificate	Popular format with Microsoft products.
X.509 certificate in PEM file	One or more X.509 certificates	Popular format in the Unix world. X.509 DER certificate is base64 encoded and placed between "-----BEGIN CERTIFICATE-----" and "-----END CERTIFICATE-----" lines. Multiple certificates can be repeated in the same file.
ASN.1 DER encoded X.509 CRL	One X.509 CRL	Most basic format supported for CRL.
X.509 CRL in PEM file	One X.509 CRL	Same format as X.509 certificate in PEM format, except that the lines contain BEGIN CRL and END CRL.

## Default CA certificates

The following certificates are installed by default:

- **SOAP API Certificate Authority:** Before allowing a SOAP client to connect, the AP checks the certificate supplied by a SOAP client to ensure that it is issued by a trusted certificate authority (CA).
- **Dummy Authority:** Used by the internal RADIUS server. You should replace this with your own CA certificate.

---

**NOTE:** For security reasons, you should replace the default certificates with your own.

---

## Certificate and private key store

This list displays all certificates installed on the AP. The AP uses these certificates and private keys to authenticate itself to peers.

Items provided in this list are as follows:

**Status indicator**

Indicates the certificate state.

- **Green:** Certificate is valid.
- **Yellow:** Certificate will expire soon.
- **Red:** Certificate has expired.

**ID**

A sequentially assigned number to help identify certificates with the same common name.

**Issued to**

Name of the certificate holder. Select the name to view the contents of the certificate.

**Issued by**

Name of the CA that issued the certificate.

**Current usage**

Lists the services that are currently using this certificate.

**Start/Expiration date**

Indicates the period during which the certificate is valid.

**Delete**

Select to remove the certificate from the certificate store.

## Installing a new private key/public key certificate chain pair

---

**NOTE:** RADIUS EAP certificates must have the X.509 extensions. Information about this is available in the Microsoft knowledgebase at: <http://support.microsoft.com/kb/814394/en-us>

---

The certificate you install must:

- Be in PKCS #12 format.
- Contain a private key (a password controls access to the private key).
- Not have a name that is an IP address. The name should be a domain name containing at least one dot. If you try to add a certificate with an invalid name, the default certificate is restored.

The common name in the certificate is automatically assigned as the domain name of the AP.

1. Specify the name of the certificate file or select **Browse** to choose one from a list. Certificates must be in PKCS #7 format.
2. Specify the **PKCS #12 password**.
3. Select **Install** to install the certificate.

## Default installed private key/public key certificate chains

The following private key/public key certificate chains are installed by default:

- **wireless.hp.internal:** Default certificate used by the management tool, SOAP server, and HTML-based authentication.
- **Dummy Server Certificate:** Used by the internal RADIUS server. This certificate is present only to allow EAP-PEAP to work if the client chooses not to verify the server's certificate. You should replace this with your own certificate for maximum security.
- **Management Console Default client certificate:** This certificate is used to identify the management tool when it communicates with HP PCM/PMM software.



**NOTE:** When a Web browser connects to the AP using SSL/TLS, the AP sends only its own X.509 certificate to the browser. This means that if the certificate has been signed by an intermediate certificate authority, and if the Web browser only knows about the root certificate authority that signed the public key certificate of the intermediate certificate authority, the Web browser does not get the whole certificate chain it needs to validate the identity of the AP. Consequently, the Web browser issues security warnings. To avoid this problem, make sure that you install the entire certificate chain when you install a new certificate on the AP.

**NOTE:** An SNMP notification can be sent to let you know when the AP SSL certificate is about to expire. To enable this notification, select **Management > SNMP** and enable the **Notifications** option. Then select **Configure Notifications**, enable **Event notifications**, and then select the event **Maintenance certificate about to expire** under **System**. See “[Configuring SNMP notifications for events](#)” (page 87).

## Certificate usage

To see the services that are associated with each certificate, select **Security > Certificate usage**. With the factory default certificates installed, the page will look like this:

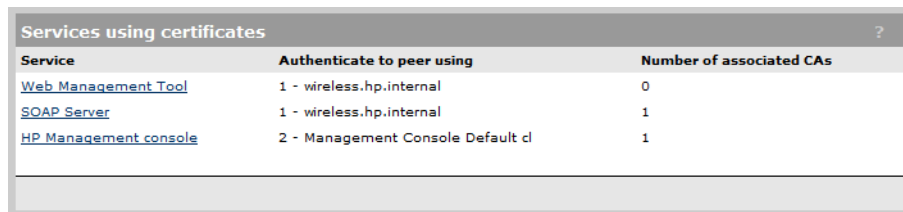

Service	Authenticate to peer using	Number of associated CAs
<a href="#">Web Management Tool</a>	1 - wireless.hp.internal	0
<a href="#">SOAP Server</a>	1 - wireless.hp.internal	1
<a href="#">HP Management console</a>	2 - Management Console Default cl	1

### Service

Name of the service that is using the certificate. To view detailed information on the certificate select the service name.

### Authenticate to peer using

Name of the certificate and private key. The AP is able to prove that it has the private key corresponding to the public key in the certificate. This is what establishes the AP as a legitimate user of the certificate.

### Number of associated CAs

Number of CA certificates used by the service.

### Changing the certificate assigned to a service.

Select the service name to open the Certificate details page. For example, if you select **Web Management Tool**, you will see:

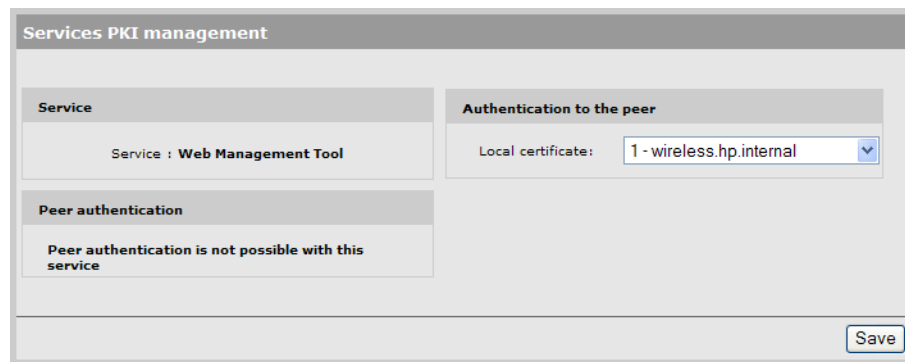

Services PKI management

Service: **Web Management Tool**

Authentication to the peer  
Local certificate: 1 - wireless.hp.internal

Peer authentication  
Peer authentication is not possible with this service

Save

Under **Authentication to the peer**, select a new **Local certificate** and then select **Save**.

## About certificate warnings

When you connect the management tool, certificate warnings occur because the default certificate installed on the AP is not registered with a certificate authority. It is a self-signed certificate that is attached to the default IP address (192.168.1.1) for the AP.

To continue to work with the management tool without installing a certificate, select the option that allows you to continue to the Website.

To eliminate these warnings you can do one of the following:

- Obtain a registered X.509 (SSL) certificate from a recognized certificate authority and install it on the AP. This is the best solution, since it ensures that your certificate can be validated by any web browser. A number of companies offer this service for a nominal charge. These include: Thawte, Verisign, and Entrust.
- Become a private certificate authority (CA) and issue your own certificate: You can become your own CA. and create as many certificates as you require. However, since your CA will not be included in the internal list of trusted CAs maintained by most browsers, users will get a security alert until they add your CA to their browser.

## Certificate expiration alerts

The following warnings are generated when a certificate is about to expire:

- The status light for the certificate turns yellow. See “Trusted CA certificate store” (page 102).
- A message appears on the management tool home page. For example:

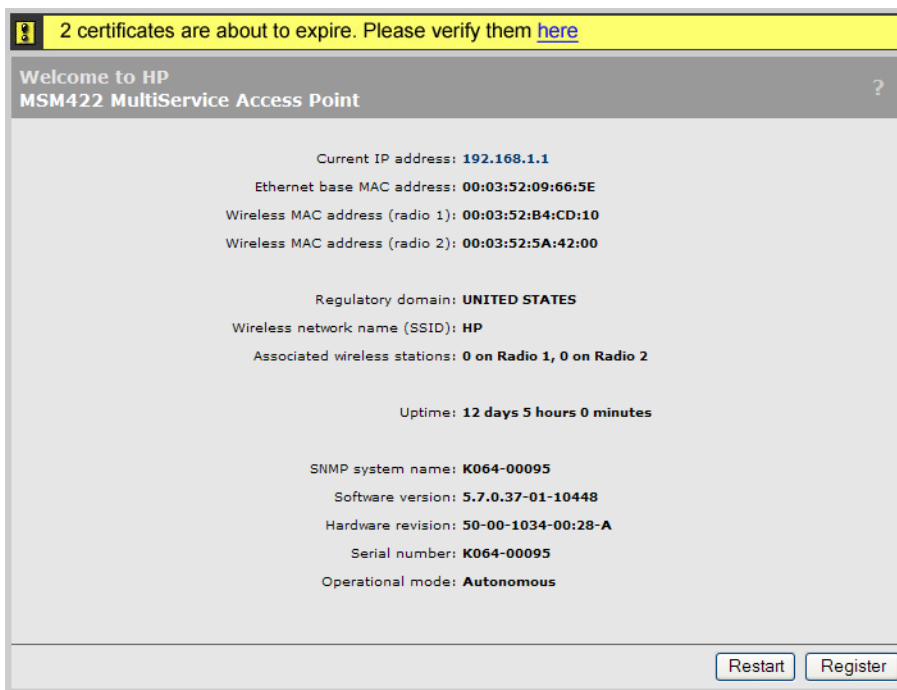

- The following syslog message is sent every 24 hours:  
*Warning: n certificate(s) is(are) about to expire. Please go to the Certificates page for more information.*  
Where n is the number of certificates that are about to expire.
- When logging into the CLI, a message similar to the syslog message above is displayed.

## MAC lockout

This feature lets you to block traffic from client stations based on their MAC address. MAC lockout applies to client stations connected to:

- Wireless ports
- Wired ports (including switch ports)
- Local mesh ports

## Configuring MAC lockout

Before you can configure MAC lockout, you must define one or more MAC address lists.

1. Select **Security > MAC lockout**.

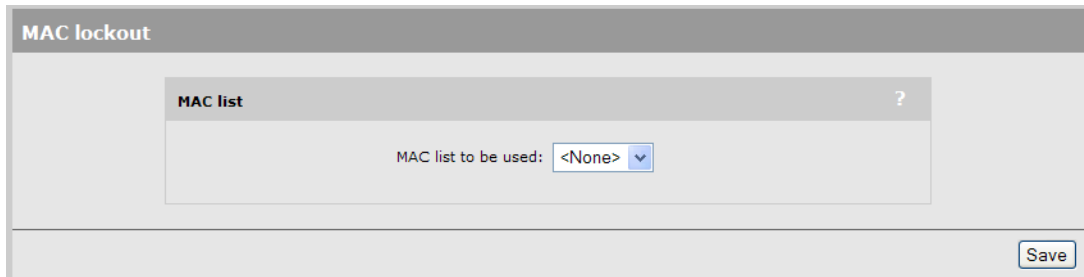

2. Select the MAC address list to use.
3. Select **Save**.

## Configuring MAC address lists

MAC lists are used by several options to allow/deny access to client stations. You can define up to 75 MAC address lists with up to 256 entries in each list. The lists can be used to define MAC addresses for the following features:

- The **MAC filter** option in a VSC. When used with this feature, a maximum of 256 addresses are supported per list.
- The **MAC lockout** feature. When used with this feature, a maximum of 64 addresses are supported per list.

The total number of MAC addresses defined for all lists cannot exceed 4800.

To define a MAC list, do the following:

1. Select **Security > MAC lists**.

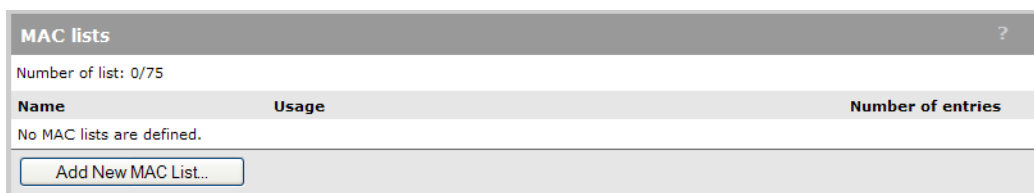

2. Select **Add New MAC List**. The Add/Edit MAC list page opens.

Each entry in the MAC list contains a MAC address and its associated mask. By varying the mask, an entry can be defined to match a single address or a range of addresses.

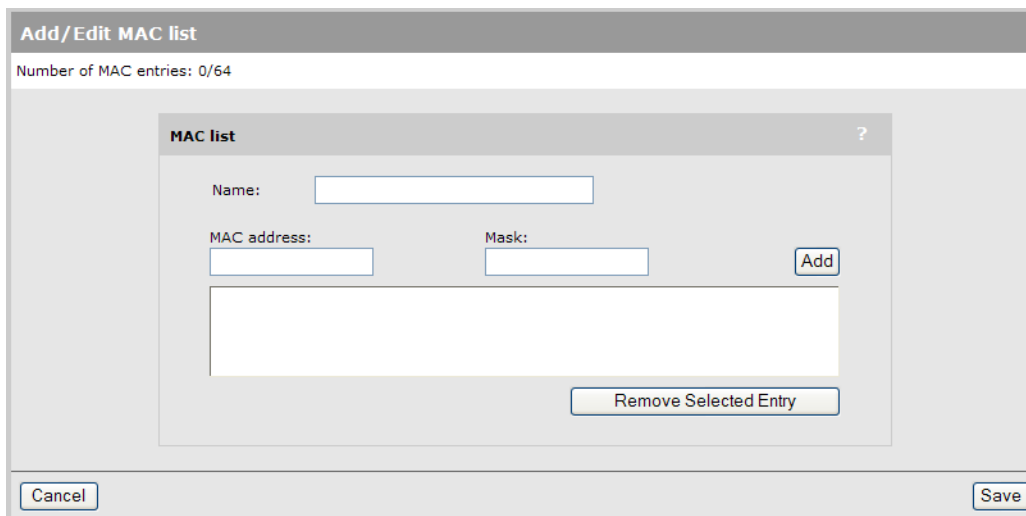

3. Specify a **Name** to identify the MAC address list.
4. Specify the **MAC address** and **Mask** that you want to match, then select **Add**. Setting the **Mask** to **00:00:00:00:00:00** is allowed, but not recommended since it will match all MAC addresses.
5. Repeat step 4 until you have defined all needed entries.
6. Select **Save**.

## Matching MAC addresses

### Matching a single MAC address

To match a single MAC address, specify the address using 12 hexadecimal numbers in the format: **nn:nn:nn:nn:nn:nn**, and set the **Mask** to: **FF:FF:FF:FF:FF:FF**

For example, this definition matches a single MAC address:

MAC address = 00:03:52:07:2B:43

Mask = FF:FF:FF:FF:FF:FF

### Matching a range of MAC addresses

To match a range of MAC addresses, you need to use the wildcard feature. A value of **00** in a mask means that the corresponding position in the address is a wildcard (i.e., it can be any value).

For example, to match all address that begin with the prefix 00:03:52 you would define:

MAC address = 00:03:52:00:00:00

Mask = FF:FF:FF:00:00:00

Wildcards can be placed anywhere (but must always be 00, half-byte masks such as F0 are not supported). Multiple wildcards can be used.

For example, this entry matches all the addresses that have their first three bytes set to 00:03:52 and the final bytes set to AA:FF

MAC address = 00:03:52:00:AA:FF

Mask = FF:FF:FF:00:FF:FF

# 10 Local mesh

## Key concepts

The local mesh feature enables you to create wireless links between two or more APs. These links provide a wireless bridge that interconnects the networks connected to the Ethernet port on each AP.

For example, AP #2 and AP #3 use the local mesh feature to create a wireless link between the main office network and a small network in a warehouse.

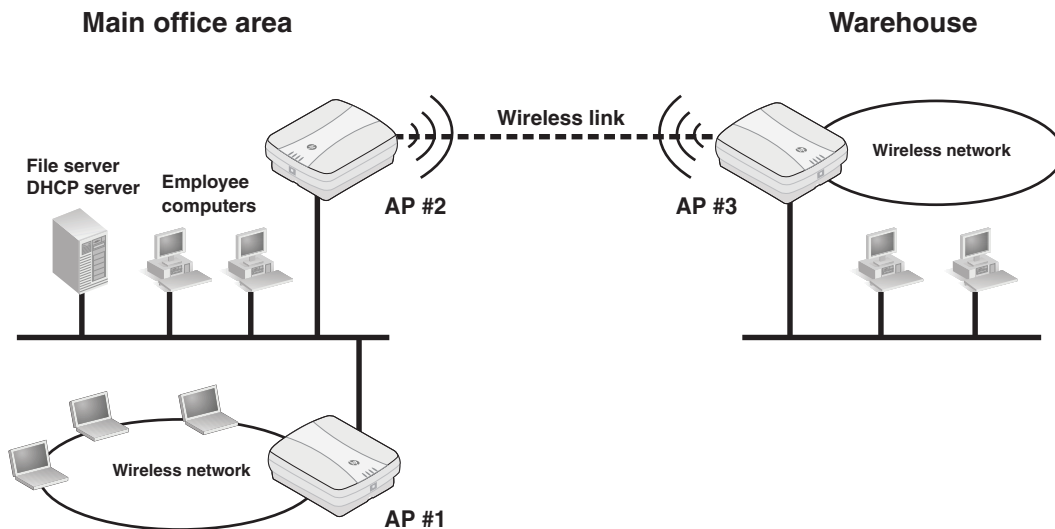

The local mesh feature replaces the need for Ethernet cabling between APs, making it easy to extend your network in hard-to-wire locations or in outdoor areas.

Key local mesh features include:

- **Automatic link establishment:** Nodes automatically establish wireless links to create a full-connected network. A dynamic network identifier (local mesh group ID) restricts connectivity to groups of nodes, enabling distinct groups to be created with nodes in the same physical area.
- **Provides fall-back operation to recover from node failure.** In a properly designed implementation, redundant paths can be provided. If a node fails, the mesh will automatically reconfigure itself to maintain connectivity.
- **Maintains network integrity when using DFS channels.** In accordance with the 802.11h standard, dynamic frequency selection (DFS) detects the presence of certain radar devices on a channel and automatically switches the network node to another channel if such signals are detected. 802.11h is intended to resolve interference issues with military radar systems and medical devices.

---

**NOTE:** Depending on the radio regulations of some countries, DFS channels are only available on the 802.11ac/n/a bands, which are the preferred band for local mesh backhaul. If more than one node detects radar simultaneously and must switch channels, each node does not necessarily switch to the same channel, and the network might never reconverge. To avoid this problem, local mesh detects a change in channel and provides a means to reconnect on other channels by scanning on multiple channels. See [“Operating channel” \(page 113\)](#).

---

## Simultaneous AP and local mesh support

APs can be configured to support both access point and local mesh functionality whether they have a single radio, or multiple radios.

---

**NOTE:** HP strongly recommends that the same AP model be used at both ends of a local mesh link. Mixing recent APs (MSM430, MSM46x, HP 560) with older APs (MSM3xx, MSM422) may cause a local mesh link to stop working after a software upgrade.

---

## Single radio APs

A single radio can be configured to simultaneously support wireless users and one or more local mesh links. Although this offers flexibility, it does have the following limitations:

- The total available bandwidth on the radio is shared between all local mesh links and wireless users. This can result in reduced throughput if lots of traffic is being sent by both wireless users and the local mesh links. You can use the QoS feature to prioritize traffic.
- It limits you to using the same radio options for both wireless clients and local meshes.

## Multiple radio APs

On APs with more than one radio, one radio can be dedicated to support wireless users and another to provide local mesh links. Each radio can be configured optimally according to its application.

## Controlled APs

Controlled APs can be managed over local mesh links.

## Using 802.11ac/n/a for local mesh

HP recommends that 802.11ac/n/a in the 5 GHz band be used for local mesh links whenever possible. This optimizes throughput and reduces the potential for interference because:

- Most Wi-Fi clients support 802.11b or b/g, therefore most APs are set to operate in the 2.4 GHz band. This frees the 5 GHz (802.11ac/n/a) band for other applications such as local mesh.
- 802.11ac/n/a channels in the 5 GHz band are non-overlapping.
- 802.11ac/n/a provides increased data throughput, providing a *fat pipe* for traffic exchange.

The main limitations in using the 5 GHz band are:

- Since the same radio options must be used for both wireless clients and local mesh links, support for 802.11b/g clients is not possible on APs with a single radio.
- The 5 GHz band has a shorter reach when compared to the 2.4 GHz band. This could be a factor depending on the distance your links must span.

## Local mesh link types

Two types of local mesh links are supported: static and dynamic.

### Static local mesh links

Static local mesh links can be used to create a fixed wireless connection between two APs, creating a wireless bridge between the networks connected to the two APs. For example, in the following scenario, a static wireless link is created between AP 1 and AP 2. Each AP is connected to a separate physical network, but both networks are on the same IP subnet (192.168.5.0). Traffic is bridged across the wireless link, allowing User A to communicate with User B.

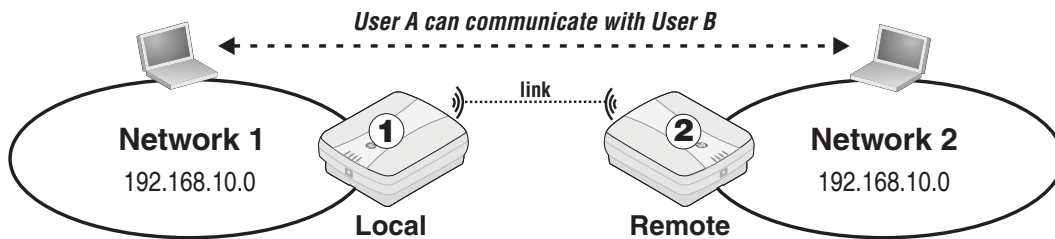

## Terminology

The following terms are used in this guide when discussing the static local mesh feature.

Term	Definition
Local	The AP that you are currently configuring to support a static link.
Remote	The AP that to which the static link will connect.
Link	The wireless connection between a local and remote AP.

## Configuration guidelines

The following guidelines apply when you create a static local mesh link between two or more APs:

- All radios used to establish the link must be set to the same operating frequency and channel. This means that on the **Wireless > Radio** page under **Channel**, you cannot select Automatic.
- All APs must be on the same subnet, and each AP must have a unique IP address.
- If AES/CCMP security is enabled, the same key must be defined on all APs.
- Only one static wireless link can be defined between any two APs.

## Dynamic local mesh links

The dynamic local mesh feature enables an AP to automatically find and connect with other APs to automatically create wireless links. When multiple APs are properly configured, they can automatically combine to create a mesh topology that is self-configuring and self-healing. For example, in the following scenario, a dynamic local mesh is composed of five APs. When the APs are started, they automatically establish the connections to build the mesh based on their role (master, alternate master, slave). If AP 2 fails, AP 4 automatically switches its connection to AP 3.

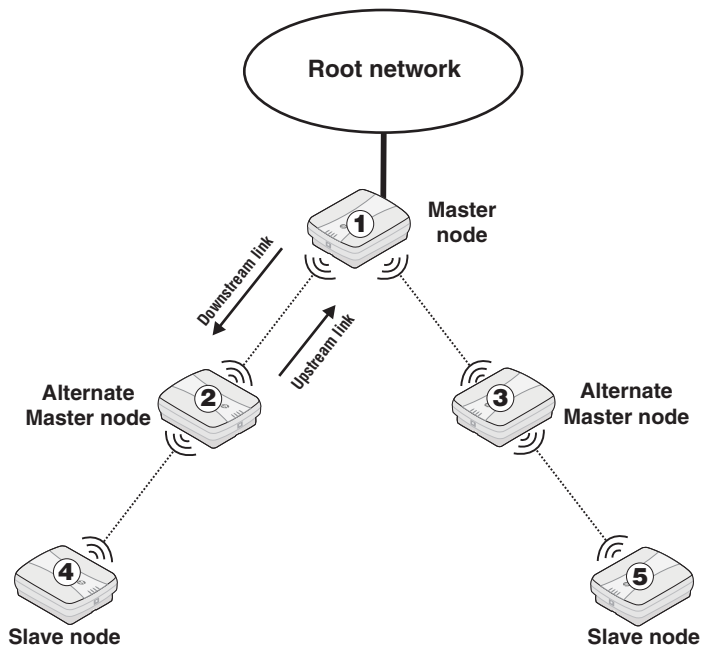

Traffic is bridged across the wireless links, allowing users connected to any AP to reach the root network.

## Terminology

The following illustration and table define terms that are used in this guide when discussing the dynamic local mesh feature.

Term	Definition
Node	An AP that is configured to support local mesh connections.
Root node	The root node is configured in <b>Master</b> mode and provides access to the root network.
Alternate master node	A node that is configured in <b>Alternate master</b> mode, which enables it to make upstream and downstream connections.
Slave node	A node that is configured in <b>Slave</b> mode, which enables it to make upstream connections only.
Root network	Wired network to which the root node is connected. This is the network to which the local mesh provides access for all connected alternate master and slave nodes.
Mesh	A series of nodes that connect to form a network. Each mesh is identified by a unique mesh ID.
Link	The wireless connection between two nodes.
Downstream link	A link that transports data away from the root network.
Upstream link	A link that transports data towards the root network.
Peer	Any two connected nodes are peers. In the diagram, AP 1 is the peer of both AP 2 and AP 3.



## Operational modes

Three different roles can be assigned to a local mesh node: **Master**, **Alternate Master**, or **Slave**. Each role governs how upstream and downstream links are established by the node.

- **Master:** Root node that provides the upstream link to the ground network that the other nodes want to reach. The master never tries to connect to any other node. It waits for links from downstream alternate master or slave nodes.

---

**NOTE:** It is possible to have several masters for the same mesh ID connected to the ground network. This can be used to provide redundant paths to the ground network for downstream nodes.

---

- **Alternate Master:** First establishes an upstream link with a master or alternate master node. Next, operates as a master node waits for links from downstream alternate master or slave nodes.
- **Slave:** Can only establish an upstream link with master or alternate master node. Slave nodes cannot establish downstream links with other nodes.

## Node discovery

Discovery of another node to link with is limited to nodes with the same mesh ID. The link is established with the node that has the best score based on the following calculation:

Score = SNR - (Number of hops x SNR cost of each hop)

If a node loses its upstream link, it automatically discovers and connects to another available node.

When an AP is attempting to establish a local mesh link, the radio status light on its chassis will blink. Once the local mesh link is established, the radio status light will return to its normal operation.

## Operating channel

If a mesh operates on a dynamic frequency selection (DFS) channel, the master node selects the operating channel. If another node detects radar and switches channels, that node reports the channel switch to the master node, which initiates a channel switch for the nodes connected to it. This allows the local mesh to converge on a specific channel.

A node that uses a DFS channel and that loses connection with its master, scans channels to find a master on another channel, which can be a new master or the same master.

If the local mesh does not operate on a DFS channel, configure the radios in one of the following ways:

- Configure the radios on all nodes to use the same fixed channel.
- Configure the radios for automatic channel selection. In this case the master selects the least noisy channel. Slaves and alternate masters scan channels until they find the master, then tune to the master channel and link with the master.

## Configuration guidelines

- You can configure a total of six local mesh profiles on each node.
- Each dynamic local mesh profile (master or alternate master) can be used to establish up to nine links with other nodes.
- The same security settings must be used on all nodes in the same mesh.

## Quality of service

The local mesh feature enables you to define a quality of service (QoS) setting that will govern how traffic is sent on all wireless links.

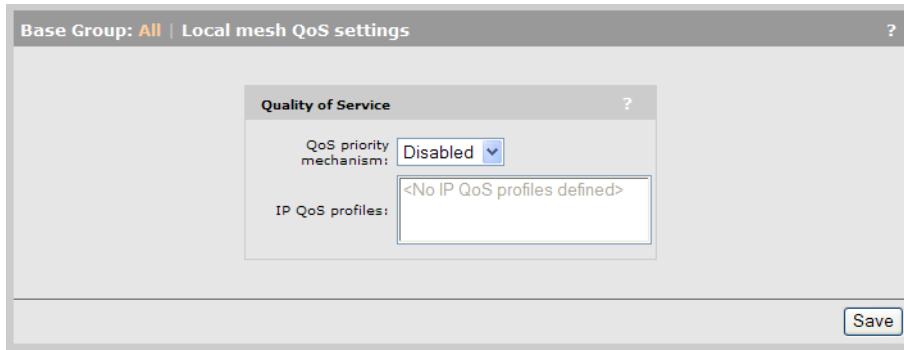

---

**NOTE:** When traffic is forwarded onto a local mesh link from a VSC, the QoS settings on the VSC take priority. For example, if you define a VSC with a QoS setting of **VSC-based High**, then traffic from this VSC will traverse the local mesh on queue 2 even if the QoS setting on the local mesh is **VSC-based Low** (queue 4).

---

### Maximum range (ack timeout)

This is a global setting that is configurable on the **Radio** page when the **Operating mode** is set to support **Local mesh**. It fine tunes internal timeout settings to account for the distance that a link spans. For normal operation, it is set to less than 1 km.

This is a global setting that applies to all wireless connections made with a radio, not just for local mesh links. Therefore, if you are also using a radio to access an AP, adjusting this setting may lower the performance for users with marginal signal strength or when interference is present. (Essentially, it means that if a frame needs to be retransmitted it will take longer before the actual retransmit takes place.)

## Local mesh profiles

A local mesh profile defines the characteristics for the type of links that can be established with other nodes as follows:

A local mesh profile defines the characteristics for the type of links that can be established with other nodes. Each node supports up to six profiles, each of which can be either static or dynamic.

- If a profile defines a static local mesh link, the profile can only be used to connect with another node with a profile that has matching settings.

If a profile defines a dynamic local mesh link, it establishes links to other nodes as follows:

Role	Upstream link	Downstream link
Master	None.	Up to nine links with alternate master or slave nodes per profile.
Alternate master	A single link to a master node or alternate master node.	Up to eight links with alternate master or slave nodes.
Slave	A single link to a master node or alternate master node.	None.

When a dynamic profile is active, the AP constantly scans and tries to establish links as defined by the profile.

## Configuring a local mesh profile

Select **Wireless > Local mesh**.

Enabled	Name	Encryption	Dynamic	Remote MAC address
Yes	<a href="#">Local_mesh_group1</a>	NONE	Yes	N/A
Yes	<a href="#">Local_mesh_group2</a>	NONE	No	00:03:52:00:00:02

Quality of Service

QoS priority mechanism: **Disabled**

IP QoS profiles: <No IP QoS profiles defined>

To configure a profile, select its name in the list. The **Local mesh profile** page opens.

Settings

Enabled  Disabled

Name: Local mesh profile

Use:  Radio 1  Radio 2

Speed: Auto

AES/CCMP Security

Key:

Confirm key:

Policy manager

Enforce node limit:  8 nodes

Addressing

Static

Remote MAC address: 00:03:52:00:00:00

Local MAC address: D4:85:64:89:97:A0

Dynamic

Mode: Master

Mesh ID: 1

Allowed downtime: 10 seconds

Maximum links: 9

Update mesh ID from server

Local mesh neighborhood

Serial #	MAC address	Mesh ID	Radio	Chan.	Mode	Avl.	Encr.	Signal	Noise	SNR
----------	-------------	---------	-------	-------	------	------	-------	--------	-------	-----

Cancel Save

## Settings

### Enabled/Disabled

Specify if the profile is enabled or disabled. The profile is only active when enabled.

**Name**

Name of the profile.

**Use**

Select the interface to use for this link.

**Speed**

(Static links only)

Sets the speed the link will operate at. For load balancing, you may want to limit the speed of a link when connecting to multiple destinations.

## AES/CCMP

Enables AES with CCMP encryption to secure traffic on the wireless link. The node uses the key you specify in the **Key** field to generate the keys that encrypt the wireless data stream.

Specify a key that is between 8 and 63 ASCII characters in length. HP recommends that the key be at least 20 characters long and be a mix of letters and numbers.

## Policy manager

The policy manager controls global configuration settings that apply to all nodes that are part of the local mesh.

For proper operation you should configure only one node as the policy manager. Setting more than one node as the policy manager will prevent policies from being properly implemented.

Although the policy manager can be any node, it is strongly recommended that you make the master node the policy manager.

When the local mesh is established, all nodes search for the policy manager and report to it.

### Enforce node limit

This policy lets you limit the total number of nodes that can make up a local mesh. When the node limit is reached, additional nodes will not be able to join the local mesh.

This policy is primarily intended to be used in train applications to prevent unwanted connections from neighboring train cars. For example, if there are eight cars in a train and two APs in each car, except for the first one, there are a total of 15 APs in the train. By setting the node limit policy to 15 nodes, when the 15 nodes in the train's local mesh are connected together, then no more nodes will be allowed to join the mesh.

## Addressing

**Static**

Use this option to create simple back-to-back links between two APs. When creating static links, both APs must be operating on the same wireless channel. Make sure that the channel selection on the **Wireless > Radio(s)** page is not set to **Automatic**.

- **Remote MAC address:** MAC address of the radio on the remote AP on which the link will be established.
- **Local MAC address:** MAC address of the radio on this AP on which the link will be established.

**Dynamic**

Use this option to create dynamic local mesh installations.

**Mesh ID**

A unique number that identifies a series of nodes that can connect together to form a local mesh network.

**Minimum SNR**

*(Alternate master or slave nodes)*

This node will only connect with other nodes whose SNR is above this setting (in dB).

### **SNR cost per hop**

*(Alternate master or slave nodes)*

This value is an estimate of the cost of a hop in terms of SNR. It indicates how much SNR a node is willing to sacrifice to connect to node one hop closer to the root node, because each hop has an impact on performance, especially when using a single radio.

### **Allowed downtime**

The maximum time (in seconds) that a link can remain idle before the link actually gets deleted. When a slave (or alternate master) loses its link to its master, the discovery phase is re-initiated.

### **Maximum links**

*(Master or alternate master nodes)*

The maximum number of upstream and downstream links that this node can support.

### **Initial discovery time**

*(Alternate master or slave nodes)*

Amount of time that will be taken to discover the best available master node. The goal of this setting is to delay discovery until all the nodes in the surrounding area have had time to startup, making the identification of the best master more accurate. If this period is too short, a slave may connect to the first master it finds, not necessarily the best.

### **Update mesh ID from server**

*(Master nodes)*

When this option is enabled, every time the node restarts, it retrieves the configuration file defined under **Scheduled operations** on the **Maintenance > Config file management** page. If the retrieved configuration file is different from the current configuration, the node loads the retrieved configuration.

### **Promiscuous mode**

*(Alternate master or slave nodes)*

Allows a node to connect to a different mesh when it cannot find a master or alternate master with its currently configured mesh ID within the specified amount of time.

Once a new master or alternate master is found, the following actions are triggered:

- The node firmware is updated using the settings configured under **Scheduled operations** on the **Maintenance > Firmware** page.
- The node configuration is updated using the settings configured under **Scheduled operations** on the **Maintenance > Config file management** page. This changes the node mesh ID to the one found in the configuration file. If no configuration file is defined, the node updates its mesh ID to match the new master or alternate master.
- An SNMP notification is sent if the configuration file or firmware fails to load.

After loading new firmware or a new configuration file, the node waits 30 seconds before restarting if a downstream link was established with another node in promiscuous mode. This provides downstream nodes with additional time during which to download new firmware and configuration files, thus improving the total convergence time of the entire network.

### **Preserve master link across reboots**

*(Alternate master or slave nodes)*

When enabled, the address of the current master to which the node is connected is saved so that if the node restarts it will reconnect to the same master bypassing the initial discovery period.

### Allow forced links

*(Alternate Master, Slave only)*

When enabled, the node will accept any connection forced from a master and it will change its mesh ID in order to use the master mesh ID. A link is forced from the master by using the force link button next to the slave's entry in the local mesh scan. A link can be forced to a slave (alternate master) in a different mesh. This will cause the slave to save the new mesh ID and use it from that point onward.

### Search for better link on minimum SNR

*(Alternate Master, Slave only)*

When enabled, if the current SNR on the link drops below the value set for Minimum SNR, the node will search for a connection to another master with a better SNR.

### Restart Discovery

*(Alternate master or slave nodes)*

This button tells the AP to bring down any link it has already established and restart looking for the best master to which it can connect. It can be used when a new master is installed close to a slave and you want the slave to connect to that master, without rebooting.

## Sample local mesh deployments

### RF extension

Local mesh provides an effective solution for extending wireless coverage in situations where it is impractical or expensive to run cabling to an AP.

In this scenario, a wireless bridge is used to extend coverage of the wireless network. Both APs are equipped with omni-directional antennas, enabling them to deliver both AP capabilities and wireless bridging using local mesh capabilities.

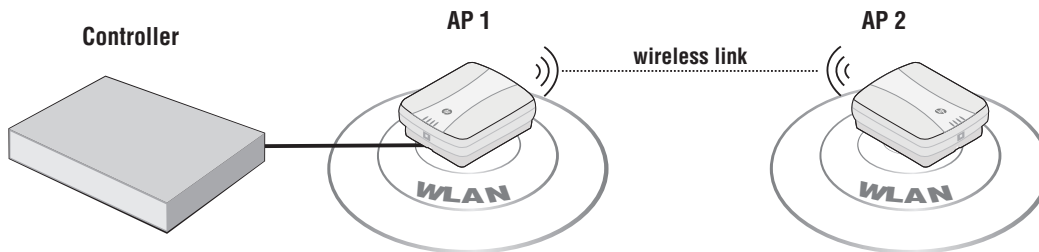

### Building-to-building connection

You can also use local mesh to create point-to-point links over longer distances. In this scenario, two dual-radio APs create a wireless link between networks in two adjacent buildings. Each AP is equipped with a directional external antenna attached to radio 1 to provide the wireless link. Omnidirectional antennas are installed on radio 2 to provide AP capabilities. The two APs are placed within line of sight.

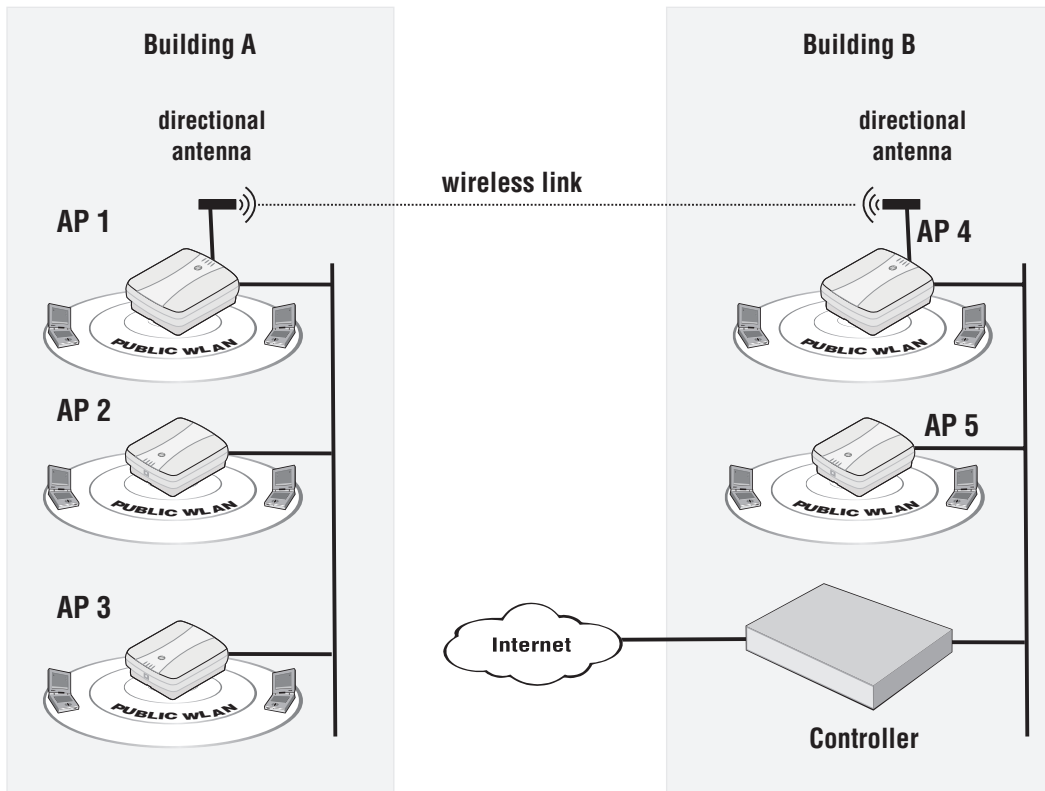

---

**NOTE:** In the above example, all APs must connect to the backbone network via port 1.

---

## Dynamic network

In this scenario, a controller is deployed with several APs to provide wireless coverage of a large area. Instead of using a backbone LAN, wireless links are used to interconnect all APs.

AP 1 is the *master*. It provides the connection to the wired network and a wireless link to the other APs. The other APs automatically established their links to the master based on a balance between SNR (signal to noise ratio) and hops, to provide the most efficient network topology.

If a node becomes unavailable, the links dynamically adjust to find the optimum path to the master.



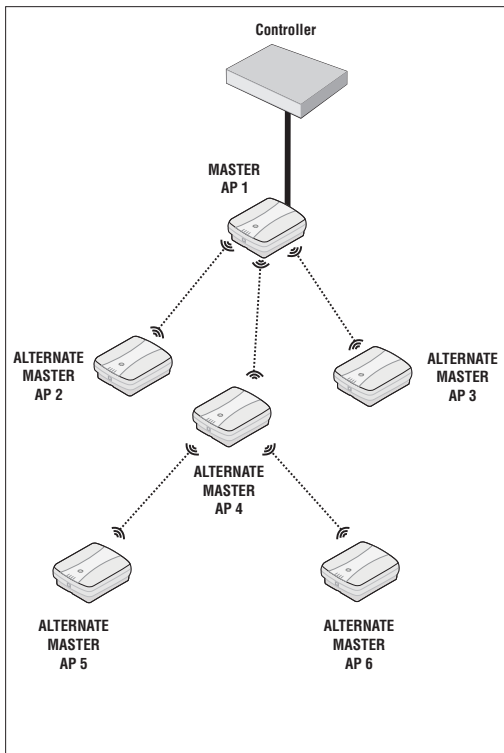

Initial network configuration is automatically established.

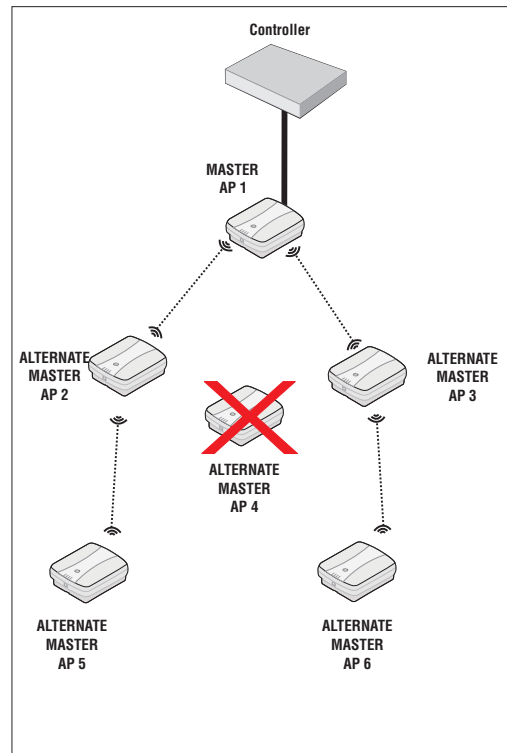

When AP 4 is unavailable, the network dynamically reconfigures itself.

# 11 Maintenance

## Config file management

The configuration file contains all the settings that customize the operation of the AP. You can save and restore the configuration file manually or automatically.

Select **Maintenance > Config file management**.

The screenshot shows a web interface titled "Config file management" with a question mark icon in the top right corner. The interface is divided into four main sections:

- Backup configuration:** Contains the instruction "Backup the current configuration file." Below this are two input fields labeled "Password:" and "Confirm password:". A "Backup..." button is located at the bottom right of this section.
- Restore configuration:** Contains the instruction "Load a configuration file." Below this is a "Config file:" input field with a "Browse..." button to its right, and a "Password:" input field below that. A "Restore" button is at the bottom right.
- Reset configuration:** Contains the instruction "Reset the configuration to factory default." followed by a **NOTE: The current operational mode will be kept.** A "Reset" button is at the bottom right.
- Scheduled operations:** This section is preceded by an unchecked checkbox. It includes a dropdown menu for "Operation:" set to "Backup", a dropdown for "Day of week:" set to "Everyday", and a "Time of day:" field with "00" in the "hh" (hour) and "00" in the "mm" (minute) positions. Below this is a "URL:" input field. "Validate" and "Save" buttons are at the bottom.

## Manual configuration file management

The following options are available for manual configuration file management.

### Backup configuration

This option enables you to backup your configuration settings so they can be easily restored in case of failure. This option is also used when you want to directly edit the configuration file.

Before you install new software, you should always make a backup of your current configuration. Select **Backup** to start the process. You will be prompted for the location to place the configuration file.

Configuration information is saved in the backup file as follows:

- **Certificates and private keys:** If you specify a password when saving the configuration file, certificates and private keys are encrypted with a key based on the password. If you do not specify a password, certificates and private keys are still encrypted, but with a default key that is identical on all APs.
- **Manager and operator username/password:** This information is not saved in the backup configuration file. This means that if you restore a configuration file, the current username and password on the AP is not overwritten.
- **All other configuration information:** All other configuration information is saved as plain text, allowing the settings to be viewed with a standard text editor.

## Reset configuration

See “Resetting to factory defaults” (page 128).

## Restore configuration

The **Restore configuration** option enables you to load a previously saved configuration file.

This option enables you to maintain several configuration files with different settings, which can be useful if you must frequently alter the configuration of the AP or if you are managing several APs from a central site.

Use the following steps to restore a saved configuration file.

1. Select **Browse** and then locate the configuration file you want to restore.
2. Select **Restore** to upload it to the AP. If the configuration file is protected with a password, you must supply the password to restore the complete configuration. If you supply an invalid password, all settings are restored except for any certificates and private keys.

---

**NOTE:** The AP automatically restarts when once the file has been loaded.

---

## Scheduled operations

The **Scheduled operations** feature enables you to schedule unattended backups or restorations of the configuration file.

Use the following steps to schedule a backup or restoration of the configuration file.

1. Select **Maintenance > Config file management**. The **Config file management** page opens.
2. Select the **Scheduled operations** checkbox.
3. For **Operation**, select **Backup** or **Restore**.
4. For **Day of week**, select **Everyday**, or select a specific day of the week on which to perform the backup or restoration.
5. For **Time of day**, specify the hour and minute on which to perform the backup or restoration. Use the format *hh mm*, where
  - *hh* ranges from 00 to 23
  - *mm* ranges from 00 to 59

If support for daylight savings time (DST) is enabled on the **Controller >> Management > System time** page, do not set **Time of day** to 2 AM, because this is when the clock is changed when adjusting for DST.

6. For **URL**, specify the path that leads to the local or remote directory in which to save the configuration file or from which to load the configuration file. For example
  - **ftp://username:password@192.168.132.11/new.cfg**
  - **http://192.168.132.11/new.cfg**

Secure transfers are supported using HTTPS or FTPS.

7. Select **Validate** to test that the specified **URL** is correct.
8. Select **Save**.

## Software updates

Software updates are managed by selecting **Maintenance > Firmware updates**.

On the MSM410, MSM430, MSM460, MSM466, MSM466-R, and HP 560:

**Firmware updates** ?

**Install firmware**

Install firmware directly to the MSM460 from your local hard drive or schedule regular uploads from a remote server.

Current firmware version: **6.5.0.0-18471**

**Manual install**

No file selected.

**Scheduled install**

Mode:

Day of week:

Time of day:  :   
hh mm

URL:

On the MSM422:

**Firmware updates** ?

**Install firmware**

Install firmware directly to the MSM720 from your local hard drive or schedule regular uploads from a remote server.

Current firmware version: **6.2.0.0-14791**

**Manual install**

**Scheduled install**

Day of week:

Time of day:  :   
hh mm

URL:

**△ CAUTION:**

- At the end of the update process, the AP automatically restarts, causing all users to be disconnected. Once the AP resumes operation, all users must reconnect. To minimize network disruption, use the scheduled install option to have updates performed outside of peak usage hours.
- When using a controller in conjunction with one or more autonomous APs, you must (1) always update the controller before updating the APs, and (2) never load an earlier software version on the APs than is installed on the controller.

## Performing an immediate software update

To update the AP software now, do the following:

1. Select **Browse**, and then locate a firmware file and select it.
2. Select **Validate** if you want to test the integrity of the selected firmware file without installing it. A message will appear at the top of the page indicating whether the firmware signature is valid or invalid.

3. Select **Install**. This will automatically test the integrity of the firmware by validating its signature. If the signature is valid, the firmware will be installed and the AP will restart. If the signature is invalid, the firmware will not be installed.

---

**NOTE:** Select **Force install** to install a firmware file without validating its integrity. Installing firmware without validating its integrity may result in the AP becoming inoperative.

---

## Performing a scheduled software update

The AP can automatically retrieve and install software from a remote site identified by its URL. To schedule software installation, follow this procedure:

1. Enable **Scheduled install**.
2. For **Day of week**, select a specific day or **Everyday** and set **Time of day**.
3. On the MSM410, MSM430, MSM460, MSM466, MSM466-R, and HP 560, set **Mode** one of the following:
  - **Preset time:** Firmware update occurs according to the settings for **Day of week** and **Time of day**.
  - **Load on reboot:** Firmware update occurs the next time the AP is restarted. An event is generated if the upgrade is not successful and the AP remains operational. Possible reasons for failure include:
    - Firmware signature is invalid.
    - Firmware version is the same as the one currently installed.If the version of the firmware being loaded is older than the one currently installed, a factory reset is done after the upgrade.
4. For **URL**, specify an address like this:
  - **ftp://username:password@192.168.132.11/newsoftware.cim**
  - **http://192.168.132.11/newsoftware.cim**Secure transfers are supported using HTTPS or FTPS.
5. Select **Validate URL** to test that the specified URL points to a firmware file.
6. Select **Save**, or to commit the schedule and also update the software immediately, select **Save and Install Now**.

---

**NOTE:** Before a scheduled software update is performed, only the first few bytes of the software file are downloaded to determine if the software is newer than the currently installed version. If it is not, the download stops and the software is not updated.

---

---

# 12 Support and other resources

## Online documentation

You can download documentation from the HP Support Center website at: [www.hp.com/support/manuals](http://www.hp.com/support/manuals). Search by product number or name.

## Contacting HP

For worldwide technical support information, see the HP Support Center website: [www.hp.com/networking/support](http://www.hp.com/networking/support)

Before contacting HP, collect the following information:

- Product model names and numbers
- Technical support registration number (if applicable)
- Product serial numbers
- Error messages
- Operating system type and revision level
- Problem description and any detailed questions

## HP websites

For additional information, see the following HP websites:

- [www.hp.com/networking](http://www.hp.com/networking)
- [www.hp.com](http://www.hp.com)

## Typographic conventions

**Table 1 Document conventions**

Convention	Element
Blue text: <a href="#">Table 1 (page 126)</a>	Cross-reference links
Blue, underlined text: <a href="http://www.hp.com">www.hp.com</a>	Website addresses
<b>Bold</b> text	<ul style="list-style-type: none"><li>• Keys that are pressed</li><li>• Text typed into a GUI element, such as a box</li><li>• GUI elements that are clicked or selected, such as menu and list items, buttons, tabs, and check boxes</li></ul>

---

 **WARNING!** Indicates that failure to follow directions could result in bodily harm or death.

---

 **CAUTION:** Indicates that failure to follow directions could result in damage to equipment or data.

---

 **IMPORTANT:** Provides clarifying information or specific instructions.

---

**NOTE:** Provides additional information.

---

 **TIP:** Provides helpful hints and shortcuts.

---

# A Console ports

## Console port connector specifications

The console ports are wired as described in this section.

### MSM422 console port

The MSM422 provide a DB-9 (female) console (serial) port connector. The DB-9 connector (DCE) has pin assignments as follows:

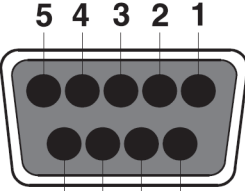
Pin	Signal	Direction	Connector
1	DCD	→ to PC	 <p>DB-9 (female)</p>
2	RXD	→ to PC	
3	TXD	← from PC	
4	DTR	← from PC	
5	GND		
6	DSR	→ to PC	
7	RTS	← from PC	
8	CTS	→ to PC	
9	Unused		

To connect to a computer, use a standard (straight-through) serial cable (male-to-female).

### MSM410, MSM430, MSM460, and MSM466 console port

These APs provide an RJ-45 console (serial) port connector. Use an RJ-45 to DB-9 adapter cable (not supplied) with an RJ-45 (male) connector on one end and a DB-9 (female) connector on the other end. Wire the cable as follows:

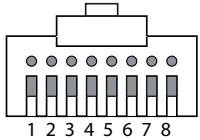
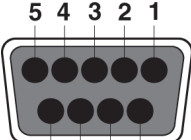
RJ-45 (male)	Pins	Signal	Direction	Pins	DB-9 (female)
	1	CTS	to PC	8	
	2	DSR	to PC	6	
	3	TXD	from PC	3	
	4	GND			
	5	GND		5	
	6	RXD	to PC	2	
	7	DTR	from PC	4	
	8	RTS	from PC	7	

**NOTE:** The DSR and DTR signals are only supported on the MSM410.

---

## B Resetting to factory defaults

### Read this before resetting to factory defaults

Resetting an AP to factory defaults has the following effects:

- The AP is returned to controlled mode operation. If required, switch the AP back to autonomous mode as described in the product Quickstart.
- All user-defined configuration settings are deleted and returned to factory default settings, which includes:
  - The manager username and password are set to *admin*.
  - The DHCP client is enabled on any Ethernet ports. If no DHCP server assigns an address to the AP, its address defaults to 192.168.1.1.
- User-installed licenses are retained after a reset to factory defaults.

### Resetting to factory defaults

Use the procedures in this section to set an AP to its factory default settings.

#### Using the reset button

This technique forces the AP into its factory defaults state including switching the AP back into controlled mode.

Using a tool such as a paper clip, press and hold the reset button for a few seconds until the front status lights blink three times.

#### Using the management tool

Launch the management tool (default <https://192.168.1.1>).

To reset the AP to factory defaults, **keeping it in autonomous mode**, follow this procedure:

1. Select **Maintenance > Config file management**.



2. Under **Reset configuration**, select **Reset**.

The screenshot shows a web interface titled "Config file management". It is divided into several sections:

- Backup configuration:** Contains the instruction "Backup the current configuration file." and two input fields for "Password:" and "Confirm password:". A "Backup..." button is located at the bottom right of this section.
- Restore configuration:** Contains the instruction "Load a configuration file." and a "Config file:" input field with a "Browse..." button next to it. Below it is a "Password:" input field and a "Restore" button.
- Reset configuration:** Contains the instruction "Reset the configuration to factory default. **NOTE: The current operational mode will be kept.**" and a "Reset" button.
- Scheduled operations:** This section is currently unchecked. It includes a dropdown menu for "Operation:" set to "Backup", a dropdown for "Day of week:" set to "Everyday", and a "Time of day:" field with "00" for hours and "00" for minutes. Below this is a "URL:" input field and "Validate" and "Save" buttons.

To reset the AP to factory defaults and **FORCE it back into its default controlled mode**, follow this procedure:

1. Select **Maintenance > System**.
2. Under **Factory reset**, select **Reset to Factory Default**.

The screenshot shows a web interface titled "System". It contains several sections:

- Save system information:** Contains the instruction "Download system information for troubleshooting purposes." and a "Download..." button.
- Restart:** Contains the instruction "Restart the MSM422." and a "Restart" button.
- Factory reset:** Contains the instruction "Reset the MSM422 to its factory defaults. **IMPORTANT: All configuration settings will be erased and the MSM422 will restart in its factory default operational mode.**" and a "Reset to Factory Default" button.
- Switch operational mode:** Contains the instruction "Switch the MSM422 to controlled mode. **IMPORTANT: All configuration settings will be reset to their factory defaults.**" and a "Switch to Controlled Mode" button.
- Provision for controlled mode operation:** Contains the instruction "Provision the MSM422 controlled mode settings." and a "Provision..." button.

## Disabling the reset button on an AP

In certain cases it may be useful to disable the functionality of the reset button on an AP as follows:

1. Select **Management > Hardware**.

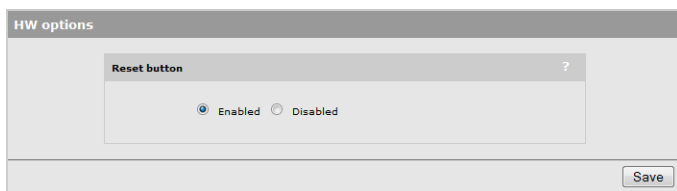

2. Under **Reset button**, select **Disabled**.
3. Select **Save**.

Once this is done, pressing the reset button on the AP will have no effect, **except** during a brief time period after the AP is powered-on. During this brief period the reset button functions as normal.

# C Connecting external antennas

## Introduction

- ⚠ CAUTION:** This appendix provides mandatory radio power-level settings that must be configured to ensure that your device complies with regulatory requirements in your region. Depending on the country of use, the antenna selected, and your radio settings, it may be mandatory to reduce the radio transmission power level to maintain regulatory compliance. For specific power limits for your country, consult the *Antenna Power-Level Setting Guide* (for MSM Products) available from [www.hp.com/support/manuals](http://www.hp.com/support/manuals).

This appendix applies to you if you use any of the HP antennas discussed in this appendix with HP MSM access points.

Guides for the antennas discussed in this appendix are available online from: [www.hp.com/support/manuals](http://www.hp.com/support/manuals). Search by product number or name.

### 802.11n MIMO antennas for the MSM466 and MSM466-R

These 802.11n MIMO antennas are certified only for use with the MSM466 and MSM466-R Access Points.

Part	Type	Band	Gain	Use	Elements
J9171A	Omni-directional	2.4/5 GHz	3/4 dBi	Indoor	3
J9659A	Omni-directional	2.4/5 GHz	1.5/5 dBi	Indoor	6
J9169A	Narrow Beam Sector	2.4/5 GHz	8/10.7 dBi	Outdoor	3
J9170A	Directional	2.4/5 GHz	10.9/13.5 dBi	Outdoor	3
J9719A	Omni-directional	2.4 GHz	6 dBi	Outdoor	3
J9720A	Omni-directional	5 GHz	8 dBi	Outdoor	3

**⚠ Antennas J9169A and J9170A:**

In the European Community, these antennas can only be used in the 5470-5725 MHz band. In the USA, these antennas can be only be used in the 5725-5850 MHz band.

### 802.11a/b/g antennas for MSM APs

Antennas included with MSM310, MSM310-R, MSM320, and MSM320-R

Included with	Antenna Type	Antenna Band (GHz)			
		2.4	5.15 - 5.35	5.47 - 5.725	5.725 - 5.850
MSM310 & MSM320(J9401A)	Omni	2.5 dBi	3.0 dBi	3.4 dBi	3.4 dBi
MSM310-R & MSM320-R	Omni	5.6 dBi	N/A	NA	N/A

**CAUTION:** When using antennas outdoors, a lightning arrester is required for lightning protection. Consider placing the lightning arrester immediately before the antenna cable enters the building. HP offers a lightning arrester as an accessory, HP product number J8996A.

All HP devices are designed to be compliant with the rules and regulations in locations they are sold and will be labeled as required. Any changes or modifications to HP equipment, not expressly approved by HP, could void the user's authority to operate this device. Use only antennas approved for use with this device. Unauthorized antennas, modifications, or attachments could cause damage and may violate local radio regulations in your region.

## Optional 802.11a/b/g antennas for MSM APs

These four optional 802.11a/b/g antennas are certified for use with these MSM APs:

AP	Freq.Band	Antenna			
		4.4 dBi 2.4GHz (J8441A)	7.4 dBi 2.4GHz (J8444A)	3/4 dBi Dual Band (J8997A)	6.9/7.7 dBi Dual Band (J8999A)
MSM310	2.4	Y	Y	Y	Y
	5			Y	Y
MSM310-R	2.4	Y	Y	Y	Y
	5			Y	Y
MSM320 and MSM325	2.4	Y	Y	Y	Y
	5			Y	Y
MSM320-R	2.4	Y	Y	Y	Y
	5			Y	Y
MSM422 Radio 2	2.4	Y	Y		Y
	5				Y
MSM422 Radio 1	2.4				
	5				

Y=Yes, supported.

### Antenna Notes:

- **4.4 dBi 2.4GHz Indoor/ Outdoor Omnidirectional antenna (J8441A)** is a high-performance omnidirectional collinear antenna used for 2.4 GHz RF-distribution systems. Its flattened radiation pattern focuses energy along the horizontal plane to provide extended coverage in large rooms or vaulted areas. It may also be pole-mounted.
- **7.4 dBi 2.4GHz Outdoor Omnidirectional antenna (J8444A)** is a mast-mounted antenna.
- **3/4 dBi Dual Band Diversity indoor antenna (J8997A, indoor only)** is a ceiling-mounted spatial omnidirectional array. Two independent vertically polarized radiators provide null-free omnidirectional coverage for meeting rooms, offices, or other enclosed spaces.
- **6.9/7.7 dBi Dual Band Directional antenna (J8999A, indoor / outdoor)** is a directional patch array enclosed in a UV-stable weatherproof radome. The focused radiation pattern may be used to extend point-to-point link coverage or to provide targeted sector coverage.

## Radio power-level setting example

You need to get the *HP Antennas Power-Level Setting Guide* available online from: [www.hp.com/support/manuals](http://www.hp.com/support/manuals). Search for the part number of your antenna.

In this example, an optional HP antenna J8997A is to be used on an autonomous MSM AP configured for 802.11g in the USA. Per the Maximum RF Power Setting chart screenshot below, the intersection of row **UNITED STATES** and column **802.11g Mode/J8997A**, indicates that the maximum radio power level is **15 dBm**. (Please check the actual charts in the *HP Antennas Power-Level Setting Guide* for current values).

Country / Region	Maximum RF Power Setting (dBm) for 2.4 GHz Operation							
	802.11b Mode				802.11g Mode			
	J8441A	J8444A	J8997A	J8999A	J8441A	J8444A	J8997A	J8999A
<b>AMERICAS</b>								
ARGENTINA	16	16	15	11	13	13	15	13
BRAZIL	16	16	15	11	13	13	15	13
CANADA	16	16	15	11	13	13	15	13
CHILE	15	12	17	13	15	12	17	13
COLOMBIA	16	16	15	11	13	13	15	13
MEXICO	16	16	15	11	13	13	15	13
PERU	16	16	15	11	13	13	15	13
UNITED STATES	16	16	15	11	13	13	15	13
<b>APAC</b>								
AUSTRALIA	16	16	15	11	13	13	15	13

Set the maximum power level of 15 dBm as follows (MSM310 used as example):

1. Launch the MSM AP management tool and log in.
2. Select **Wireless > Radio**.
3. For **Wireless mode**, select **802.11g**.
4. Set **Antenna gain** to the gain of the attached antenna.
5. Select **Advanced wireless settings** to expand the dialog box.
6. Under **Transmit power control** disable **Maximum available output power**.
7. To the left of **dBm**, specify the value, **15** in this example. The dialog box should now look similar to this (in this screenshot the tall dialog box is split in two):

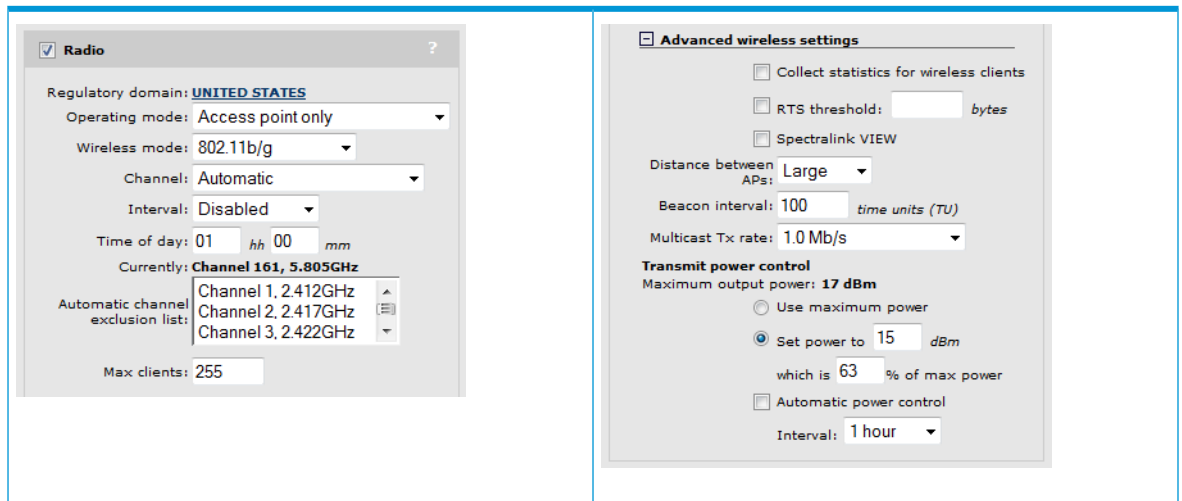

8. Select **Save**.

Additional information is available as follows:

- For autonomous access points, see [“Transmit power control” \(page 48\)](#).
- For controlled access points, see *Transmit power control* in the *MSM7xx Controllers Configuration Guide*.

Documentation is available online from: [www.hp.com/support/manuals](http://www.hp.com/support/manuals). Search by product number or name.