



LASERJET PRO 400

User Guide



M401



HP LaserJet Pro 400 M401 Printer Series

User Guide

Copyright and License

© 2012 Copyright Hewlett-Packard Development Company, L.P.

Reproduction, adaptation, or translation without prior written permission is prohibited, except as allowed under the copyright laws.

The information contained herein is subject to change without notice.

The only warranties for HP products and services are set forth in the express warranty statements accompanying such products and services. Nothing herein should be construed as constituting an additional warranty. HP shall not be liable for technical or editorial errors or omissions contained herein.

Edition 1, 4/2012

Part number: CF270-90908

Trademark Credits

Adobe®, Acrobat®, and PostScript® are trademarks of Adobe Systems Incorporated.

Apple and the Apple logo are trademarks of Apple Computer, Inc., registered in the U.S. and other countries. iPod is a trademark of Apple Computer, Inc. iPod is for legal or rightholder-authorized copying only. Don't steal music.

Bluetooth is a trademark owned by its proprietor and used by Hewlett-Packard Company under license.

Java™ is a US trademark of Sun Microsystems, Inc.

Microsoft®, Windows®, Windows® XP, and Windows Vista® are U.S. registered trademarks of Microsoft Corporation.

UNIX® is a registered trademark of The Open Group.

Table of contents

1 Product introduction	1
Product views	2
Product front view	2
Product back view	3
Serial number and model number location	3
Control panel layout	4
LCD control panel	4
Touchscreen control panel	5
Touchscreen Home screen	7
Print product reports	8
Print product reports from an LCD control panel	8
Print product reports from a touchscreen control panel	9
Printer sharing disclaimer	9
2 Paper tray	11
Supported paper sizes	12
Supported paper types	14
Load the input trays	15
Load Tray 1	15
Load Tray 2	16
Load optional Tray 3	18
3 Print	21
Supported printer drivers (Windows)	22
Change print-job settings (Windows)	24
Priority for changing print-job settings	24
Change the settings for all print jobs until the software program is closed	24
Change the default settings for all print jobs	24
Change the product configuration settings	25
Change print-job settings (Mac OS X)	26
Priority for changing print-job settings	26

Change the settings for all print jobs until the software program is closed	26
Change the default settings for all print jobs	26
Change the product configuration settings	26
Print tasks for Windows	28
Use a printing shortcut (Windows)	28
Create a printing shortcut (Windows)	29
Automatically print on both sides with Windows	31
Manually print on both sides with Windows	32
Print multiple pages per sheet with Windows	34
Select the page orientation (Windows)	36
Select the paper type (Windows)	37
Print the first or last page on different paper (Windows)	38
Scale a document to fit page size (Windows)	40
Create a booklet (Windows)	41
Print tasks for Mac OS X	43
Use a printing preset (Mac OS X)	43
Create a printing preset (Mac OS X)	43
Automatically print on both sides (Mac OS X)	43
Manually print on both sides (Mac OS X)	44
Print multiple pages on one sheet of paper (Mac OS X)	45
Select the page orientation (Mac OS X)	45
Select the paper type (Mac OS X)	45
Print a cover page (Mac OS X)	46
Scale a document to fit page size (Mac OS X)	46
Create a booklet (Mac OS X)	46
Additional print tasks (Windows)	47
Cancel a print job (Windows)	47
Select the paper size (Windows)	47
Select a custom paper size (Windows)	47
Print watermarks (Windows)	48
Additional print tasks (Mac OS X)	49
Cancel a print job (Mac OS X)	49
Select the paper size (Mac OS X)	49
Select a custom paper size (Mac OS X)	49
Print watermarks (Mac OS X)	49
Create archival-quality prints	51
Create archival-quality prints (LCD control panel)	51
Create archival-quality prints (touchscreen control panel)	51
Use HP ePrint	52
Set up HP ePrint (LCD control panel)	52
Set up HP ePrint (touchscreen control panel)	53

Use AirPrint	54
Walk-up USB printing	55

4 Manage and maintain 57

Use the HP Reconfiguration Utility to change the product connection	58
Set up HP Wireless Direct Printing	59
Use HP Web Services applications	60
Use HP Web Services applications (LCD control panel)	60
Use HP Web Services applications (touchscreen control panel)	60
Configure IP network settings	61
View or change network settings	61
Manually configure IPv4 TCP/IP parameters from the control panel	61
Manually configure IPv4 TCP/IP parameters (LCD control panel)	61
Manually configure IPv4 TCP/IP parameters (touchscreen control panel)	61
Rename the product on a network	62
Link speed and duplex settings	63
Link speed and duplex settings (LCD control panel)	63
Link speed and duplex settings (touchscreen control panel)	63
HP Device Toolbox (Windows)	65
HP Utility for Mac OS X	67
Open the HP Utility	67
HP Utility features	67
HP Web Jetadmin	68
Product security features	69
Lock the product	69
Set or change the product password	69
Economy settings	71
Print with EconoMode	71
Set the sleep delay	71
Set the sleep delay (LCD control panel)	71
Set the sleep delay (touchscreen control panel)	72
Set the Auto Power Down delay	72
Set the Auto Power Down delay (LCD control panel)	72
Set the Auto Power Down delay (touchscreen control panel)	73
Print when a toner cartridge is at estimated end of life	74
Enable or disable the At Very Low settings (LCD control panel)	74
Enable or disable the At Very Low settings (touchscreen control panel)	75
Store and recycle supplies	76
Recycle supplies	76
Toner cartridge storage	76
Replacement instructions	77

Change the toner cartridge	77
Memory	79
Update the firmware	80
Manually update the firmware (LCD control panel)	80
Manually update the firmware (touchscreen control panel)	80
Set the product to automatically update the firmware (LCD control panel)	80
Set the product to automatically update the firmware (touchscreen control panel)	81

5 Solve problems 83

Solve problems checklist	84
Step 1: Make sure that the product is set up correctly	84
Step 2: Check the cabling or wireless connection	84
Step 3: Check the control panel for error messages	85
Step 4: Check the paper	85
Step 5: Check the software	85
Step 6: Test print functionality	85
Step 7: Check the toner cartridge	85
Step 8: Try sending a print job from a computer	85
Restore the factory-set defaults	86
Restore the factory-set defaults (LCD control panel)	86
Restore the factory-set defaults (touchscreen control panel)	86
Control panel help system	87
Interpret control panel messages	88
Control panel message types	88
Control panel messages	88
10.x000 Supply Error	88
49 Error Turn off then on	88
50.x Fuser Error Turn off then on	89
51.XX Error Turn off then on	89
54.XX Error Turn off then on	89
55.X Error Turn off then on	89
57 Fan error Turn off then on	90
59.X Error Turn off then on	90
79 Error Turn off then on	90
79 Service error Turn off then on	91
Black cartridge low	91
Black cartridge very low	91
Cleaning	91
Device error Press [OK]	92
Door open	92
Genuine HP supply installed	92

Install black cartridge	92
Invalid driver Press [OK]	92
Jam in <location>	93
Jam in Tray <X> Clear jam and then Press [OK]	93
Load tray 1 <TYPE>, <SIZE>	93
Load tray 1 PLAIN <SIZE> Cleaning Mode	93
Load tray <X> Press [OK] for available media	93
Load tray <X> <TYPE> <SIZE>	94
Manual duplex Load tray <X> Press [OK]	94
Manual feed <SIZE>, <TYPE> Press [OK] for available media	94
Memory is low Press [OK]	94
Misprint Press [OK]	94
Print failure, press OK. If error repeats, turn off then on.	95
Rear door open	95
Remove shipping material from toner cartridge	95
Replace black cartridge	95
Supplies low	96
Unexpected size in tray <X> Load <size> Press [OK]	96
Unsupported black cartridge Press [OK] to continue	96
Used black cartridge is installed Press [OK] to continue	96
Paper feeds incorrectly or becomes jammed	97
The product does not pick up paper	97
The product picks up multiple sheets of paper	97
Prevent paper jams	97
Clear jams	98
Jam locations	98
Clear a jam in Tray 1	98
Clear a jam in Tray 2	100
Clear a jam in optional Tray 3	102
Clear jams from the output bin	103
Clear a jam in the duplexer area	103
Clear a jam in the fuser area	104
Improve print quality	106
Check the paper type setting (Windows)	106
Check the paper type setting (Mac OS X)	106
Check toner cartridge status	107
Print the supplies status page (LCD control panel)	107
Print the supplies status page (touchscreen control panel)	107
Check the supplies status	107
Print a cleaning page	108
Print a cleaning page (LCD control panel)	108

Print a cleaning page (touchscreen control panel)	108
Inspect the toner cartridge for damage	108
Check the paper and printing environment	110
Use paper that meets HP specifications	110
Check the product environment	110
Check print job settings	110
Check the EconoMode setting	110
Use the print driver that best meets your printing needs	111
The product does not print or it prints slowly	112
The product does not print	112
The product prints slowly	113
Solve walk-up USB printing problems	114
The USB Flash Drive menu does not open when you insert the USB accessory	114
The file does not print from the USB storage accessory	114
The file that you want to print is not listed in the USB Flash Drive menu	115
Solve direct connection problems	116
Solve wired network problems	117
Poor physical connection	117
The computer is using the incorrect IP address for the product	117
The computer is unable to communicate with the product	118
The product is using incorrect link and duplex settings for the network	118
New software programs might be causing compatibility problems	118
The computer or workstation might be set up incorrectly	118
The product is disabled, or other network settings are incorrect	118
Solve wireless network problems	119
Wireless connectivity checklist	119
The product does not print after the wireless configuration completes	119
The product does not print, and the computer has a third-party firewall installed	120
The wireless connection does not work after moving the wireless router or product	120
Cannot connect more computers to the wireless product	120
The wireless product loses communication when connected to a VPN	120
The network does not appear in the wireless networks list	120
The wireless network is not functioning	121
Perform a wireless network diagnostic test	121
Reduce interference on a wireless network	122
Solve product software problems with Windows	123
A print driver for the product is not visible in the Printer folder	123
An error message was displayed during the software installation	123
The product is in Ready mode, but nothing prints	123
Solve product software problems with Mac OS X	125
The print driver is not listed in the Print & Fax or Print & Scan list	125

The product name does not appear in the product list in the Print & Fax or Print & Scan list	125
The print driver does not automatically set up the selected product in the Print & Fax or Print & Scan list	125
A print job was not sent to the product that you wanted	126
When connected with a USB cable, the product does not appear in the Print & Fax or Print & Scan list after the driver is selected.	126
You are using a generic print driver when using a USB connection	126
Remove software (Windows)	127
Remove software (Mac OS X)	128

6 Supplies and accessories 129

Order parts, accessories, and supplies	130
HP policy on non-HP supplies	130
HP anticounterfeit Web site	130

Index 131

1 Product introduction

- [Product views](#)
- [Print product reports](#)
- [Printer sharing disclaimer](#)

Product views

Product front view

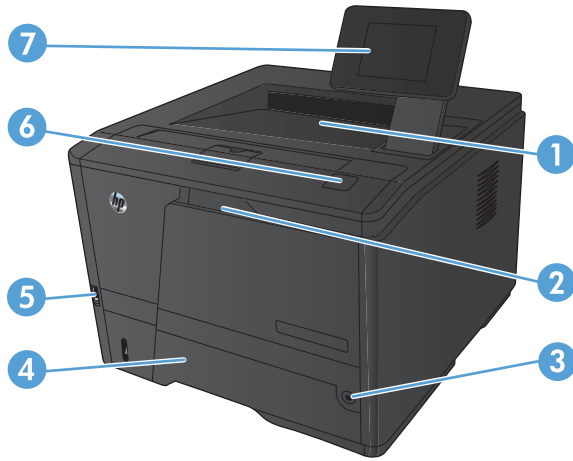

1	Output bin
2	Tray 1
3	Power button
4	Tray 2
5	Walk-up USB port (HP LaserJet Pro 400 M401dn Printer and HP LaserJet Pro 400 M401dw Printer only)
6	Toner cartridge door latch
7	LCD control panel or color touchscreen control panel (HP LaserJet Pro 400 M401dn Printer and HP LaserJet Pro 400 M401dw Printer only)

Product back view

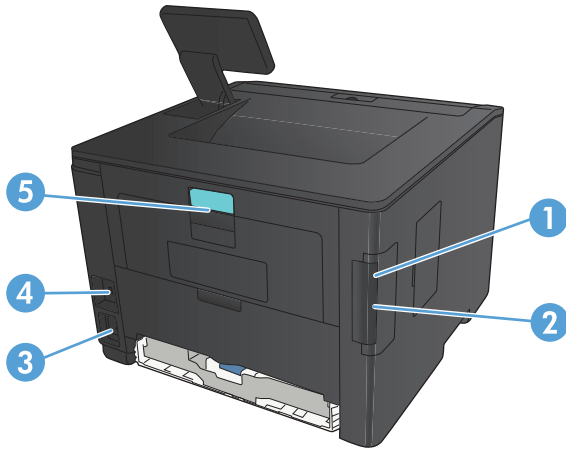

1	Hi-Speed USB 2.0 port
2	Network port (all models except HP LaserJet Pro 400 M401a Printer and HP LaserJet Pro 400 M401d Printer)
3	Power connection
4	Slot for a cable-type security lock
5	Rear jam-access door latch

Serial number and model number location



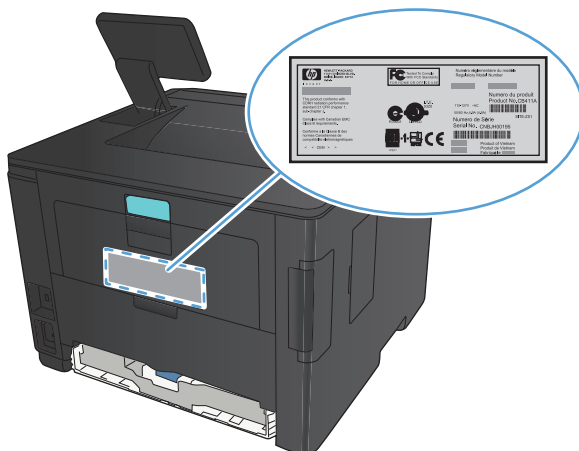

The serial number and product model number label is on the back of the product.

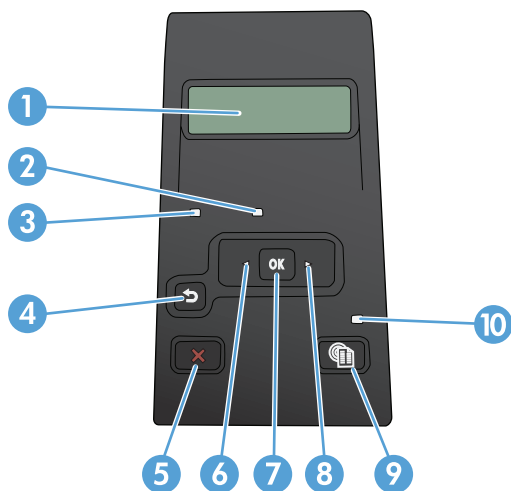

Control panel layout

LCD control panel



1	Control-panel display: The display provides information about the product. Use the menus on the display to establish product settings.
2	Attention light (amber): The Attention light blinks when the product requires user attention.
3	Ready light (green): The Ready light is on when the product is ready to print. It blinks when the product is receiving print data, or when the product is in sleep mode.
4	Back arrow  button: Use this button for the following actions: <ul style="list-style-type: none">• Exit the control-panel menus.• Scroll back to a previous menu in a submenu list.• Scroll back to a previous menu item in a submenu list (without saving changes to the menu item).
5	Cancel  button: Press this button to cancel a print job whenever the attention light is blinking or to exit the control-panel menus.
6	Left arrow  button: Use this button to navigate through the menus or to decrease a value that appears on the display.
7	OK button: Press the OK button for the following actions: <ul style="list-style-type: none">• Open the control-panel menus.• Open a submenu displayed on the control-panel display.• Select a menu item.• Clear some errors.• Begin a print job in response to a control-panel prompt (for example, when the message Press [OK] to continue appears on the control-panel display).
8	Right arrow  button: Use this button to navigate through the menus or to increase a value that appears on the display.

9	Setup  button: This button provides quick access to the Setup menu.
10	LED light: This light is not functional on this product.

Touchscreen control panel

 **NOTE:** The touchscreen control panel is available on the HP LaserJet Pro 400 M401dn Printer model and the HP LaserJet Pro 400 M401dw Printer model.

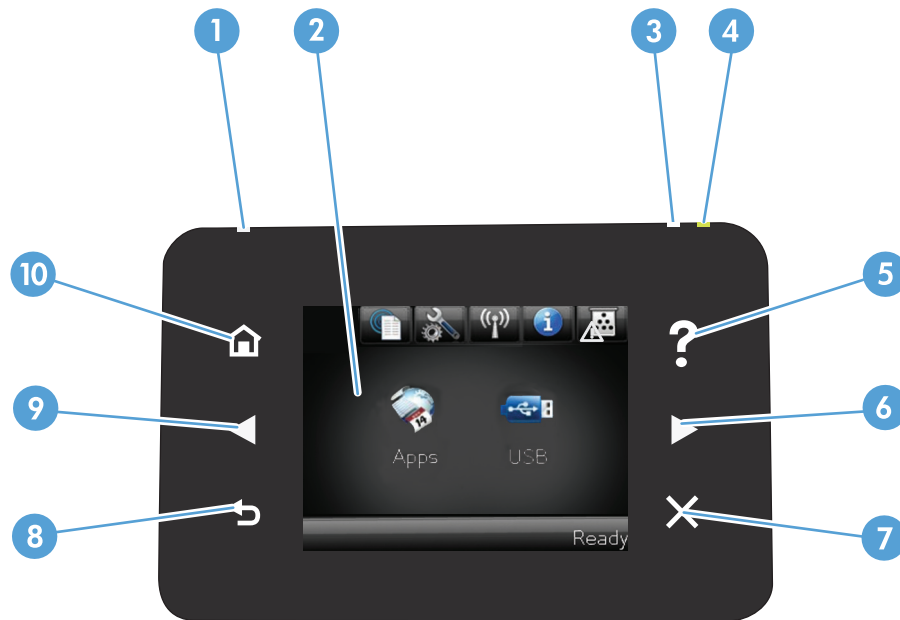

1	Wireless light: indicates the wireless network is enabled. The light blinks while the product is establishing a connection to the wireless network (available on the HP LaserJet Pro 400 M401dw Printer model only).
2	Touchscreen display
3	Attention light: indicates a problem with the product
4	Ready light: indicates the product is ready
5	Help button and light: provides access to the control panel help system
6	Right arrow button and light: moves the cursor to the right or moves the display image to the next screen NOTE: This button illuminates only when the current screen can use this feature.
7	Cancel button and light: clears settings, cancels the current job or exits the current screen NOTE: This button illuminates only when the current screen can use this feature.
8	Back button and light: returns to the previous screen NOTE: This button illuminates only when the current screen can use this feature.

9	Left arrow button and light: moves the cursor to the left NOTE: This button illuminates only when the current screen can use this feature.
10	Home button and light: provides access to the Home screen





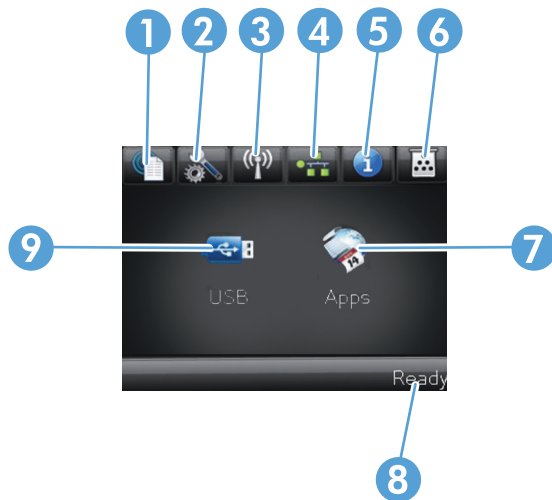

Touchscreen Home screen

 **NOTE:** The touchscreen control panel is available on the HP LaserJet Pro 400 M401dn Printer model and the HP LaserJet Pro 400 M401dw Printer model.

The Home screen provides access to the product features, and it indicates the product status.

 **NOTE:** Depending on the product configuration, the features on the Home screen can vary. The layout might also be reversed for some languages.



1	<p>Web Services  button: provides quick access to HP Web Services features, including HP ePrint</p> <p>HP ePrint is a tool that prints documents by using any email enabled device to send them to the product's email address.</p>
2	<p>Setup  button: provides access to the main menus</p>
3	<p>Wireless  button: provides access to the Wireless Menu and wireless status information (HP LaserJet Pro 400 M401dw Printer model only)</p> <p>NOTE: When you are connected to a wireless network, this icon changes to a set of signal strength bars.</p>
4	<p>Network  button: provides access to network settings and information (HP LaserJet Pro 400 M401n Printer, HP LaserJet Pro 400 M401dn Printer, and HP LaserJet Pro 400 M401dw Printer models only). From the network settings screen, you can print the Network Summary page.</p>
5	<p>Information  button: provides product status information. From the status summary screen, you can print the Configuration Report page.</p>
6	<p>Supplies  button: provides information about supplies status. From the supplies summary screen, you can print the Supplies Status page.</p>
7	<p>Apps button: provides access to the Apps menu to print directly from Web applications that you have downloaded from the HP ePrintCenter Web site at www.hpeprintcenter.com</p>
8	<p>Product status</p>
9	<p>USB button: provides access to the USB Flash Drive menu</p>

Print product reports

Product reports reside within the product memory. These pages help diagnose and solve problems with the product.



NOTE: If the product language was not correctly set during installation, you can set the language manually so the information pages print in one of the supported languages. Change the language by using the **System Setup** menu on the control panel or the embedded Web server.

From the **Reports** menu, you can print several informative pages about the product.

Menu item	Description
Demo Page	Prints a page that demonstrates print quality
Menu Structure	Prints a map of the control panel-menu layout. The active settings for each menu are listed.
Configuration Report	Prints a list of all the product settings. Includes network information when the product is connected to a network.
Supplies Status	Prints the status for each toner cartridge, including the following information: <ul style="list-style-type: none">• Estimated percentage of cartridge life remaining• Approximate pages remaining• Part number for HP toner cartridge• Number of pages printed• Information about ordering new HP toner cartridges and recycling used HP toner cartridges
Network Summary	Prints a list of all product network settings (all models except HP LaserJet Pro 400 M401a Printer and HP LaserJet Pro 400 M401d Printer)
Usage Page	Prints a page that lists PCL pages, PCL 6 pages, PS pages, pages that were jammed or mispicked in the product, monochrome (black and white) or color pages; and reports the page count
PCL Font List	Prints a list of all the PCL fonts that are installed
PS Font List	Prints a list of all the PostScript (PS) fonts that are installed
PCL6 Font List	Prints a list of all the PCL6 fonts that are installed
Service Page	Prints the service report

Print product reports from an LCD control panel

1. On the product control panel, press the **OK** button to open the menus.
2. Open the **Reports** menu.
3. Select the report you want to print, and then press the **OK** button to print the report.

Print product reports from a touchscreen control panel

1. From the Home screen on the product control panel, touch the Setup  button.
2. Touch the **Reports** button.
3. Touch the name of the report that you want to print.

Printer sharing disclaimer

HP does not support peer-to-peer networking, as the feature is a function of Microsoft operating systems and not of the HP printer drivers. Go to Microsoft at www.microsoft.com.

2 Paper tray

- [Supported paper sizes](#)
- [Supported paper types](#)
- [Load the input trays](#)

Supported paper sizes

This product supports a number of paper sizes, and it adapts to various media.

 **NOTE:** To obtain best results, select the correct paper size and type in the print driver before printing.

Table 2-1 Supported paper and print media sizes

Size and dimensions	Tray 1	Tray 2	Optional 500-sheet Tray 3	Duplexer (duplex models only)
Letter 216 x 279 mm (8.5 x 11 in)	✓	✓	✓	✓
Legal 216 x 356 mm (8.5 x 14 in)	✓	✓	✓	✓
A4 210 x 297 mm (8.27 x 11.69 in)	✓	✓	✓	✓
A5 148 x 210 mm (5.83 x 8.27 in)	✓	✓	✓	
A6 105 x 148 mm (4.1 x 5.8 in)	✓	✓	✓	
B5 (JIS) 182 x 257 mm (7.17 x 10.12 in)	✓	✓	✓	
Executive 184 x 267 mm (7.24 x 10.51 in)	✓	✓	✓	
Postcard (JIS) 100 x 148 mm (3.9 x 5.8 in)	✓			
Double Postcard (JIS) 148 x 200 mm (5.8 x 7.9 in)	✓			
16K 184 x 260 mm (7.2 x 10.2 in)	✓			
16K 195 x 270 mm (7.7 x 10.6 in)	✓			
16K 197 x 273 mm (7.8 x 10.8 in)	✓			
8.5 x 13 216 x 330 mm (8.5 x 13 in)	✓	✓	✓	

Table 2-1 Supported paper and print media sizes (continued)

Size and dimensions	Tray 1	Tray 2	Optional 500-sheet Tray 3	Duplexer (duplex models only)
Envelope Commercial #10 105 x 241 mm (4.13 x 9.49 in)	✓			
Envelope B5 ISO 176 x 250 mm (6.7 x 9.8 in)	✓			
Envelope C5 ISO 162 x 229 mm (6.93 x 9.84 in)	✓			
Envelope DL ISO 110 x 220 mm (4.33 x 8.66 in)	✓			
Envelope Monarch 98 x 191 mm (3.9 x 7.5 in)	✓			
Custom 76 x 127 mm to 216 x 356 mm (3.0 x 5.0 in to 8.5 x 14 in)	✓			

Supported paper types

For a complete list of specific HP-brand paper that this product supports, go to www.hp.com/support/lijm401series.

Paper type (control panel)	Paper type (print driver)	Tray 1	Tray 2	Optional 500-sheet Tray 3	Duplexer (duplex models only)
PLAIN 75–95 G	Plain	✓	✓	✓	✓
HP EcoSMART Lite	HP EcoSMART Lite	✓	✓	✓	✓
LIGHT 60-74 G	Light 60-74g	✓	✓	✓	✓
MID-WEIGHT 96-110	Mid-weight	✓	✓	✓	✓
HEAVY 111–130 G	Heavy 111–130g	✓	✓	✓	
EXTRA HEAVY 131–175 G	Extra heavy 131–175g	✓			
TRANSPARENCY	Monochrome Laser Transparency	✓	✓	✓	
LABELS	Labels	✓			
LETTERHEAD	Letterhead	✓	✓	✓	✓
PREPRINTED	Preprinted	✓	✓	✓	✓
PREPUNCHED	Prepunched	✓	✓	✓	✓
COLOR	Colored	✓	✓	✓	✓
ROUGH	Rough	✓	✓	✓	
BOND	Bond	✓	✓	✓	✓
RECYCLED	Recycled	✓	✓	✓	✓
ENVELOPE	Envelope	✓			

Load the input trays

Load Tray 1

1. Open Tray 1, and pull the tray extension away from the product.



2. For long paper, flip out the extension to help hold the paper in the tray.

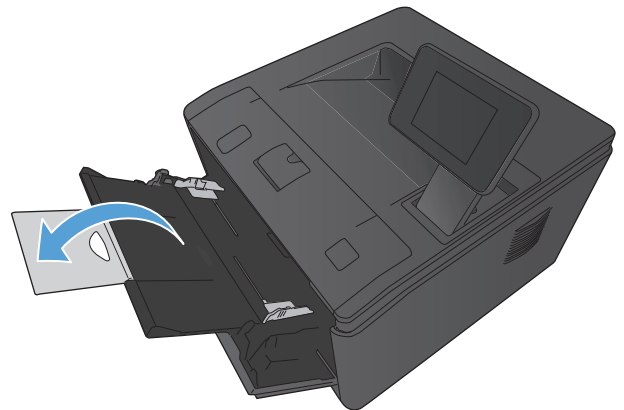

3. Place the paper stack into Tray 1, and slide the paper guides so that they are against the sheets.

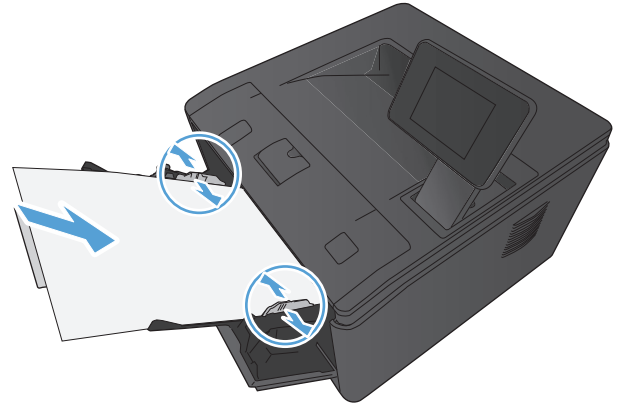

4. Feed the paper stack into the tray as far as it will go.

Load Tray 2

1. Pull the tray out of the product.

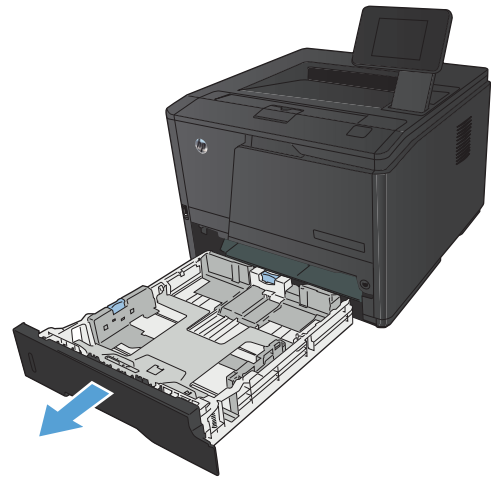

2. Slide open the paper length and width guides by pushing outward on the blue tabs.

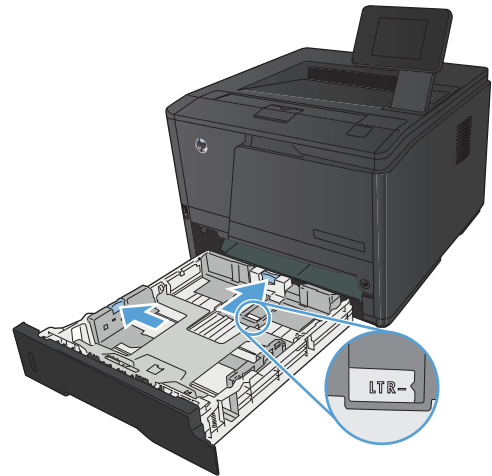

3. To load Legal-size paper, extend the tray by pressing the release button at the back of the tray inward and pulling the back of the tray out.

NOTE: When loaded with Legal-size paper, the tray extends from the rear of the product approximately 70 mm (2.75 in).

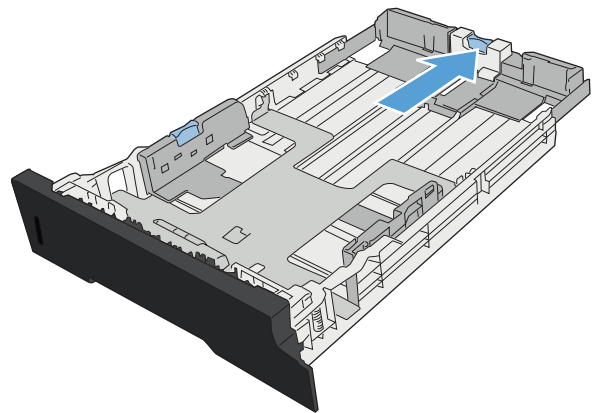

4. Place the paper in the tray and make sure that it is flat at all four corners. Slide the paper length and width guides so that they are against the stack of paper.

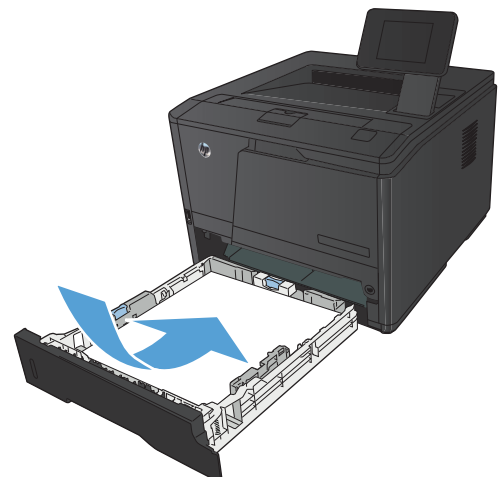

5. Push down on the paper to make sure that the paper stack is below the paper limit tabs on the right side and rear of the tray.

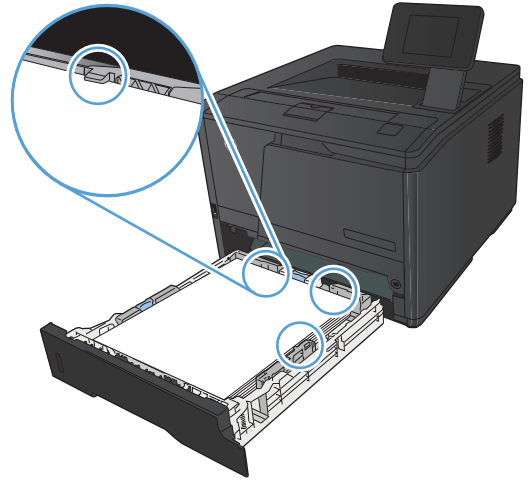

6. Slide the tray into the product.

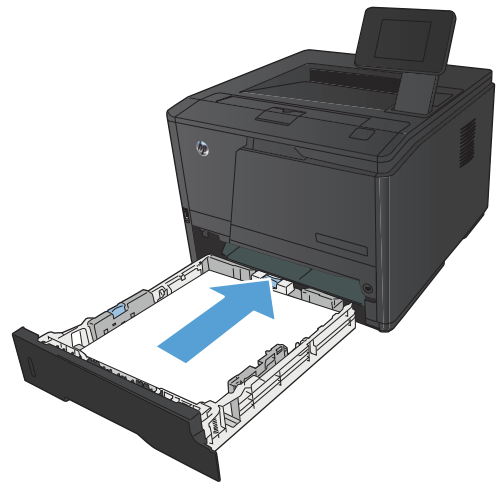

Load optional Tray 3

1. Pull the tray out of the product.

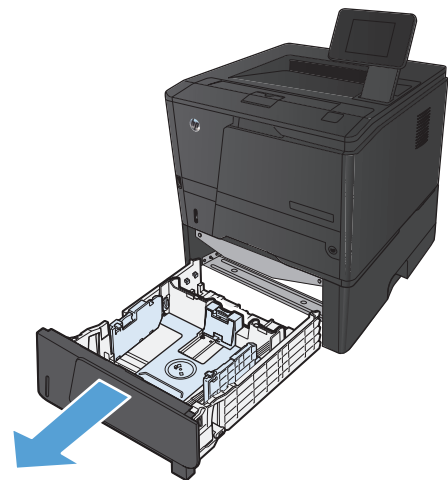

2. Slide open the paper length and width guides by pushing outward on the blue tabs.

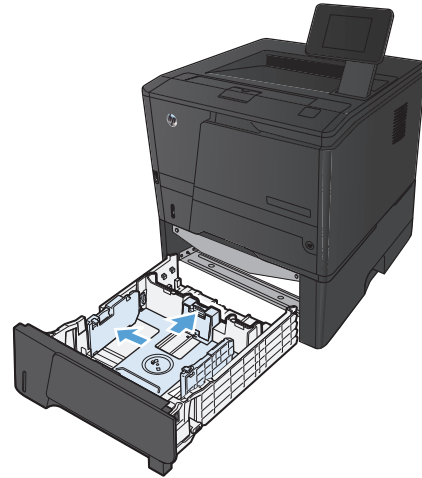

3. To load Legal-size paper, extend the tray by pressing the release button at the back of the tray inward and pulling the back of the tray out.

NOTE: When loaded with Legal-size paper, the tray extends from the rear of the product approximately 70 mm (2.75 in).

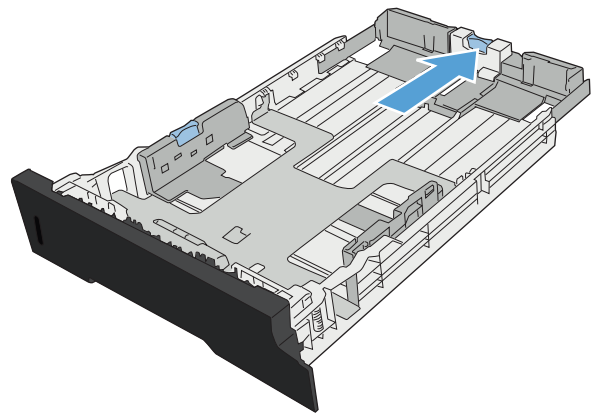

4. Place the paper in the tray and make sure that it is flat at all four corners. Slide the paper length and width guides so that they are against the stack of paper.

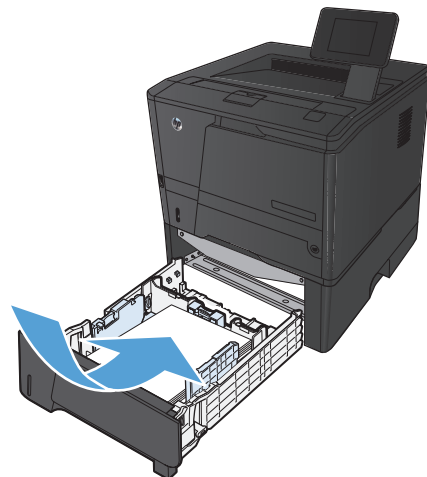

5. Push down on the paper to make sure that the paper stack is below the paper limit tabs at the rear of the tray.

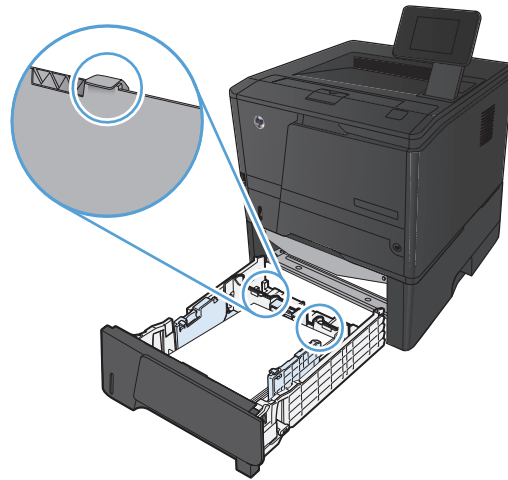

6. Slide the tray into the product.

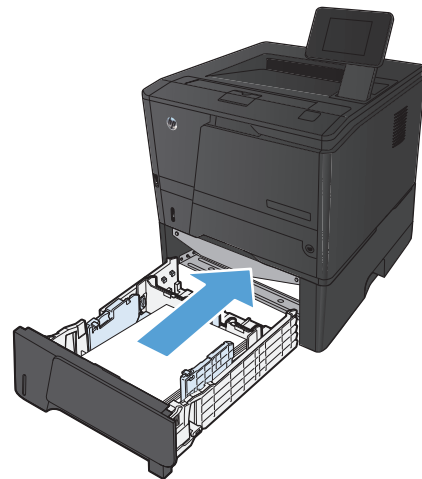

3 Print

- [Supported printer drivers \(Windows\)](#)
- [Change print-job settings \(Windows\)](#)
- [Change print-job settings \(Mac OS X\)](#)
- [Print tasks for Windows](#)
- [Print tasks for Mac OS X](#)
- [Additional print tasks \(Windows\)](#)
- [Additional print tasks \(Mac OS X\)](#)
- [Create archival-quality prints](#)
- [Use HP ePrint](#)
- [Use AirPrint](#)
- [Walk-up USB printing](#)

Supported printer drivers (Windows)

Printer drivers provide access to the product features and allow the computer to communicate with the product (using a printer language). Check the installation notes and readme files on the product CD for additional software and languages.

HP PCL 6 driver description

- Installs automatically when installing the product software
- Provided as the default driver
- Recommended for printing in all supported Windows environments
- Provides the overall best speed, print quality, and product-feature support for most users
- Developed to align with the Windows Graphic Device Interface (GDI) for the best speed in Windows environments
- Might not be fully compatible with third-party and custom software programs that are based on PCL 5

HP UPD PS driver description

- Available for download from the Web at www.hp.com/support/ljm401series
- Recommended for printing with Adobe® software programs or with other highly graphics-intensive software programs
- Provides support for printing from postscript emulation needs, or for postscript flash font support

HP UPD PCL 5 driver description

- Available for download from the Web at www.hp.com/support/ljm401series
- Compatible with previous PCL versions and older HP LaserJet products
- The best choice for printing from third-party or custom software programs
- Designed for use in corporate Windows environments to provide a single driver for use with multiple printer models
- Preferred when printing to multiple printer models from a mobile Windows computer

HP UPD PCL 6 driver description

- Available for download from the Web at www.hp.com/support/ljm401series
- Recommended for printing in all supported Windows environments
- Provides the overall best speed, print quality, and product-feature support for most users

- Developed to align with the Windows Graphic Device Interface (GDI) for the best speed in Windows environments
- Might not be fully compatible with third-party and custom software programs that are based on PCL 5

Change print-job settings (Windows)

Priority for changing print-job settings

Changes to print settings are prioritized depending on where the changes are made:

 **NOTE:** The names of commands and dialog boxes might vary depending on your software program.

- **Page Setup dialog box:** Click **Page Setup** or a similar command on the **File** menu of the program you are working in to open this dialog box. Settings changed here override settings changed anywhere else.
- **Print dialog box:** Click **Print**, **Print Setup**, or a similar command on the **File** menu of the program you are working in to open this dialog box. Settings changed in the **Print** dialog box have a lower priority and usually do not override changes made in the **Page Setup** dialog box.
- **Printer Properties dialog box (printer driver):** Click **Properties** in the **Print** dialog box to open the printer driver. Settings changed in the **Printer Properties** dialog box usually do not override settings anywhere else in the printing software. You can change most of the print settings here.
- **Default printer driver settings:** The default printer driver settings determine the settings used in all print jobs, *unless* settings are changed in the **Page Setup**, **Print**, or **Printer Properties** dialog boxes.
- **Printer control panel settings:** Settings changed at the printer control panel have a lower priority than changes made anywhere else.

Change the settings for all print jobs until the software program is closed

1. From the software program, select the **Print** option.
2. Select the driver, and then click **Properties** or **Preferences**.

Change the default settings for all print jobs

1. **Windows XP, Windows Server 2003, and Windows Server 2008 (using the default Start menu view):** Click **Start**, and then click **Printers and Faxes**.

Windows XP, Windows Server 2003, and Windows Server 2008 (using the Classic Start menu view): Click **Start**, click **Settings**, and then click **Printers**.

Windows Vista: Click **Start**, click **Control Panel**, and then in the category for **Hardware and Sound** click **Printer**.

Windows 7: Click **Start**, and then click **Devices and Printers**.

2. Right-click the driver icon, and then select **Printing Preferences**.

Change the product configuration settings

1. **Windows XP, Windows Server 2003, and Windows Server 2008 (using the default Start menu view):** Click **Start**, and then click **Printers and Faxes**.

Windows XP, Windows Server 2003, and Windows Server 2008 (using the Classic Start menu view): Click **Start**, click **Settings**, and then click **Printers**.

Windows Vista: Click **Start**, click **Control Panel**, and then in the category for **Hardware and Sound** click **Printer**.

Windows 7: Click **Start**, and then click **Devices and Printers**.

2. Right-click the driver icon, and then select **Properties** or **Printer properties**.
3. Click the **Device Settings** tab.

Change print-job settings (Mac OS X)

Priority for changing print-job settings

Changes to print settings are prioritized depending on where the changes are made:

 **NOTE:** The names of commands and dialog boxes might vary depending on your software program.

- **Page Setup dialog box:** Click **Page Setup** or a similar command on the **File** menu of the program you are working in to open this dialog box. Settings changed here might override settings changed anywhere else.
- **Print dialog box:** Click **Print**, **Print Setup**, or a similar command on the **File** menu of the program you are working in to open this dialog box. Settings changed in the **Print** dialog box have a lower priority and do *not* override changes made in the **Page Setup** dialog box.
- **Default print driver settings:** The default print driver settings determine the settings used in all print jobs, *unless* settings are changed in the **Page Setup** or **Print** dialog boxes.
- **Printer control panel settings:** Settings changed at the printer control panel have a lower priority than changes made anywhere else.

Change the settings for all print jobs until the software program is closed

1. On the **File** menu, click the **Print** item.
2. In the **Printer** menu, select this product.
3. From the settings drop-down list, change the settings that you want to change.

Change the default settings for all print jobs

1. On the **File** menu, click the **Print** item.
2. In the **Printer** menu, select this product.
3. From the settings drop-down list, change the settings that you want to change.
4. On the **Presets** menu, click the **Save As...** option and type a name for the preset.

These settings are saved in the **Presets** menu. To use the new settings, you must select the saved preset option every time you open a program and print.

Change the product configuration settings

1. From the Apple menu , click the **System Preferences** menu and then click the **Print & Fax** icon.
2. Select the product in the left side of the window.

3. Click the **Options & Supplies** button.
4. Click the **Driver** tab.
5. Configure the installed options.

Print tasks for Windows

Use a printing shortcut (Windows)

1. From the software program, select the **Print** option.
2. Select the product, and then click the **Properties** or **Preferences** button.

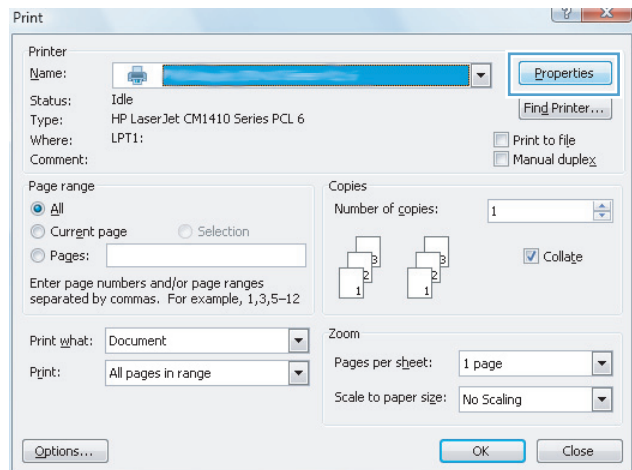

3. Click the **Printing Shortcuts** tab.

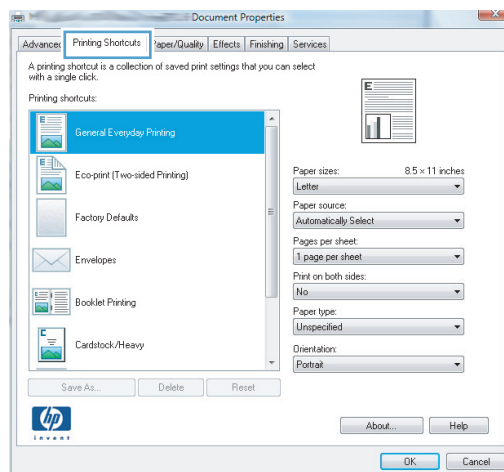

4. Select one of the shortcuts, and then click the **OK** button.

NOTE: When you select a shortcut, the corresponding settings change on the other tabs in the printer driver.

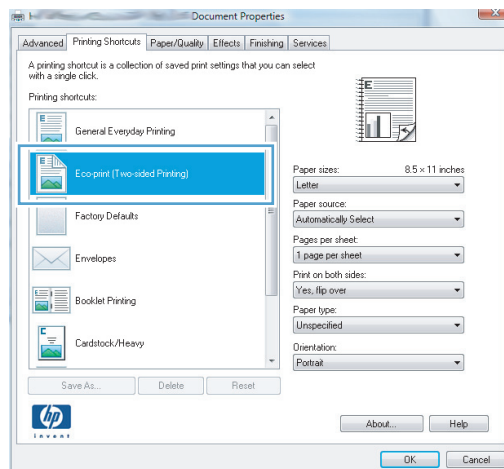

Create a printing shortcut (Windows)

1. From the software program, select the **Print** option.
2. Select the product, and then click the **Properties** or **Preferences** button.

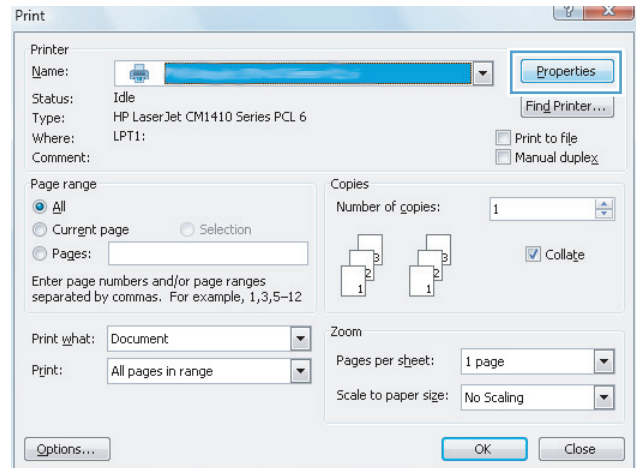

3. Click the **Printing Shortcuts** tab.

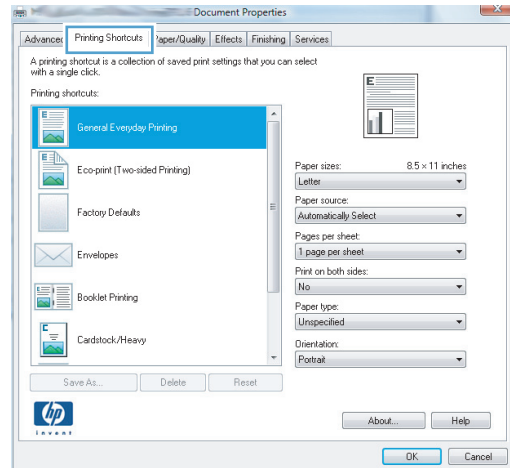

4. Select an existing shortcut as a base.

NOTE: Always select a shortcut before adjusting any of the settings on the right side of the screen. If you adjust the settings and then select a shortcut, or if you select a different shortcut, all your adjustments are lost.

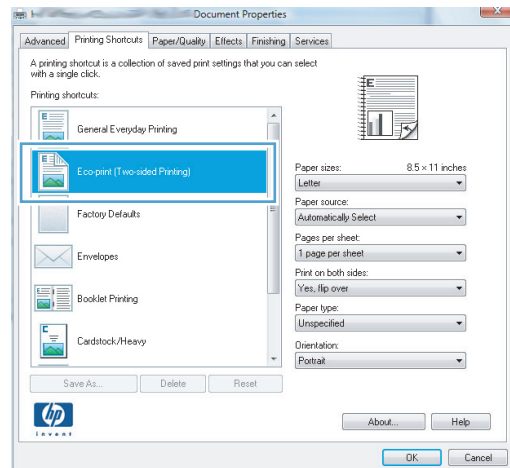

5. Select the print options for the new shortcut.

NOTE: You can select the print options on this tab or on any other tab in the printer driver. After selecting options on other tabs, return to the **Printing Shortcuts** tab before continuing with the next step.

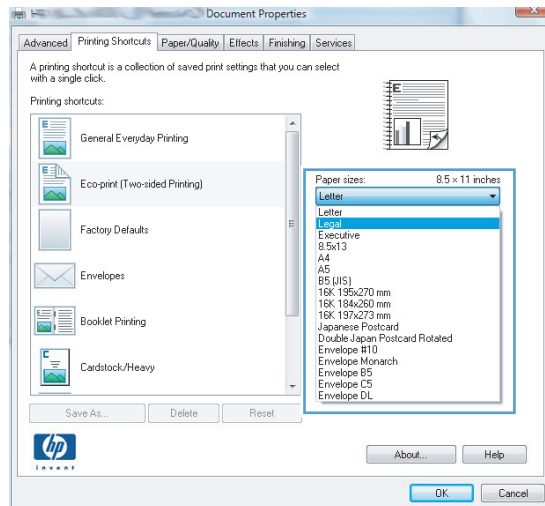

6. Click the **Save As** button.

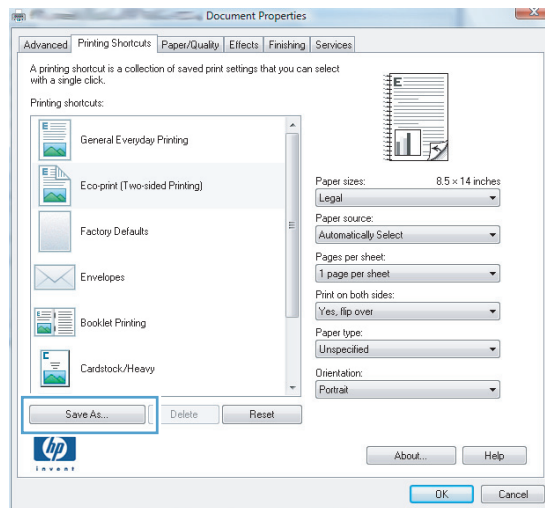

7. Type a name for the shortcut, and click the **OK** button.

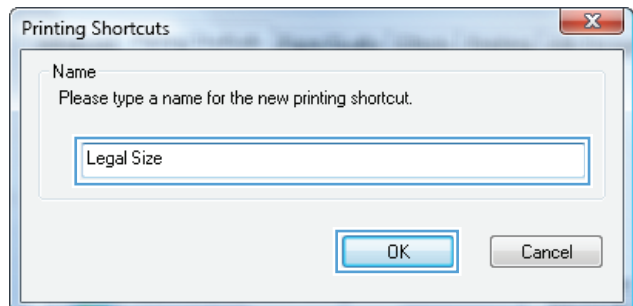

Automatically print on both sides with Windows

 **NOTE:** This section applies to the HP LaserJet Pro 400 M401d Printer, HP LaserJet Pro 400 M401dn Printer, and HP LaserJet Pro 400 M401dw Printer models only.

1. On the **File** menu in the software program, click **Print**.

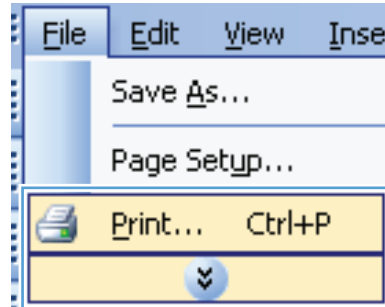

2. Select the product, and then click the **Properties** or **Preferences** button.

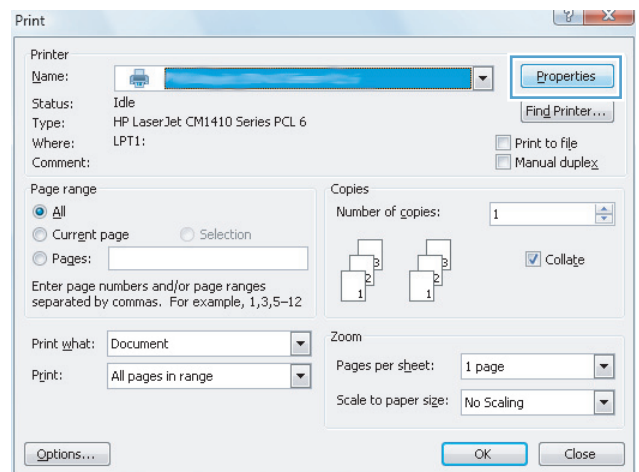

3. Click the **Finishing** tab.

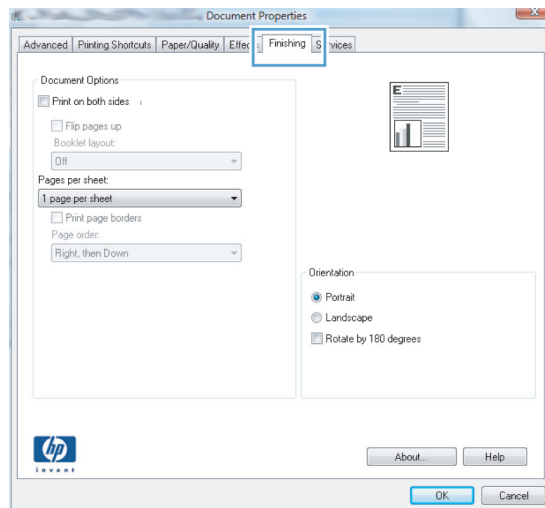

4. Select the **Print on both sides** check box. Click the **OK** button to print the job.

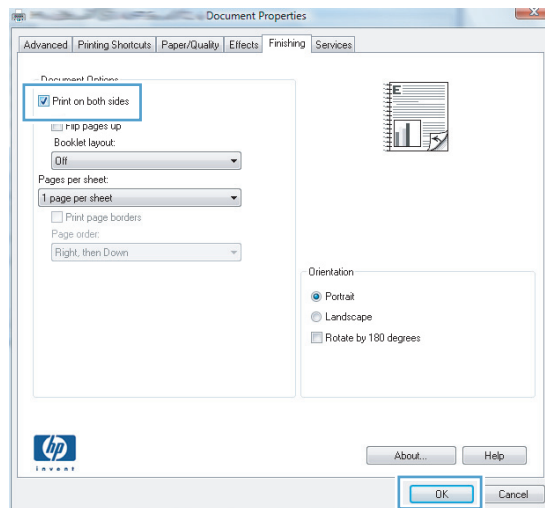

Manually print on both sides with Windows

 **NOTE:** This section primarily applies to the HP LaserJet Pro 400 M401a Printer and HP LaserJet Pro 400 M401n Printer models. However, the HP LaserJet Pro 400 M401d Printer, HP LaserJet Pro 400 M401dn Printer, and HP LaserJet Pro 400 M401dw Printer models also can print two-sided jobs manually if the paper is not supported by automatic two-sided printing, or if the duplexing unit has been disabled.

1. On the **File** menu in the software program, click **Print**.

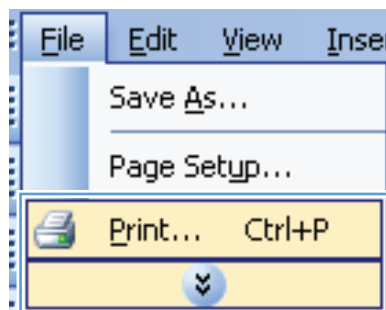

2. Select the product, and then click the **Properties** or **Preferences** button.

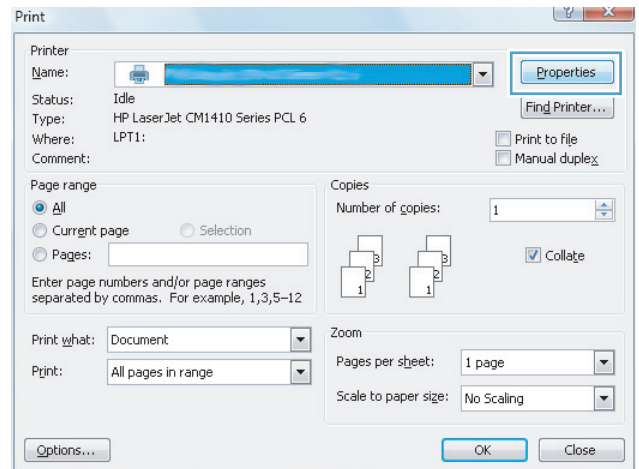

3. Click the **Finishing** tab.

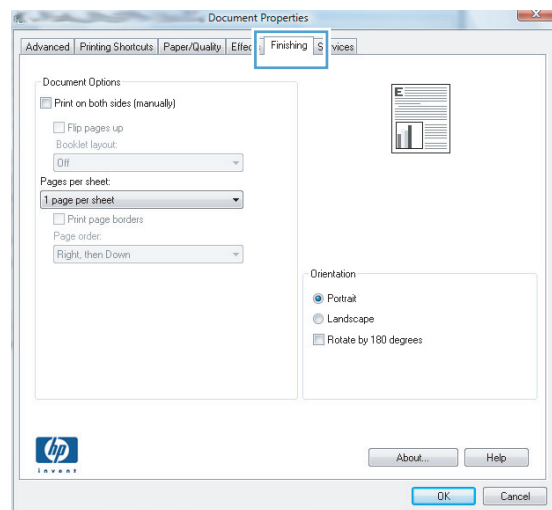

4. Select the **Print on both sides (manually)** check box. Click the **OK** button to print the first side of the job.

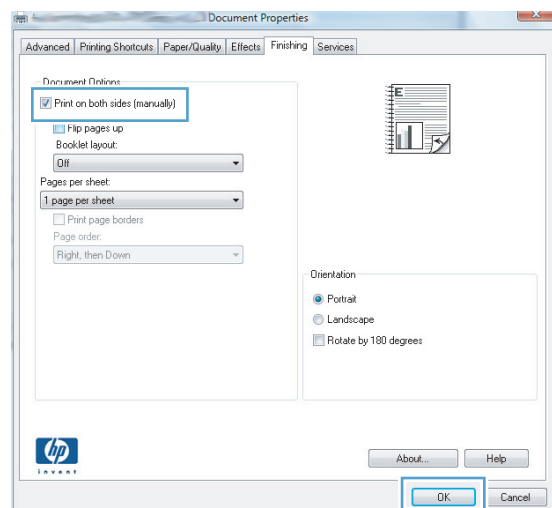

- Retrieve the printed stack from the output bin and, maintaining the same orientation, place it in Tray 1 with the printed side down and the top of the pages toward the product.

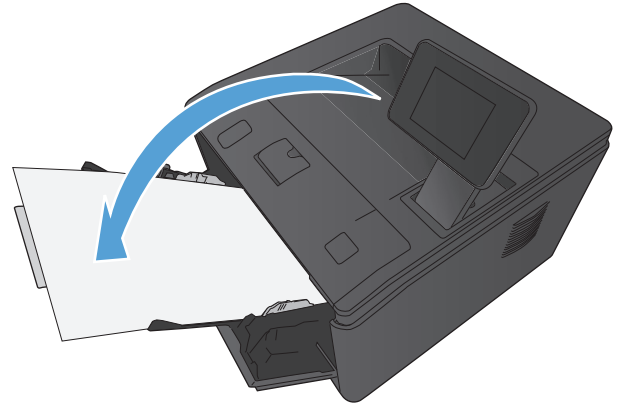

- On the control panel, press the **OK** button to print the second side of the job.

Print multiple pages per sheet with Windows

- On the **File** menu in the software program, click **Print**.

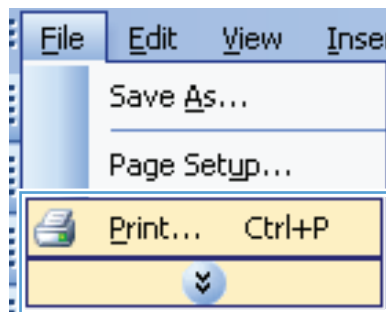

- Select the product, and then click the **Properties** or **Preferences** button.

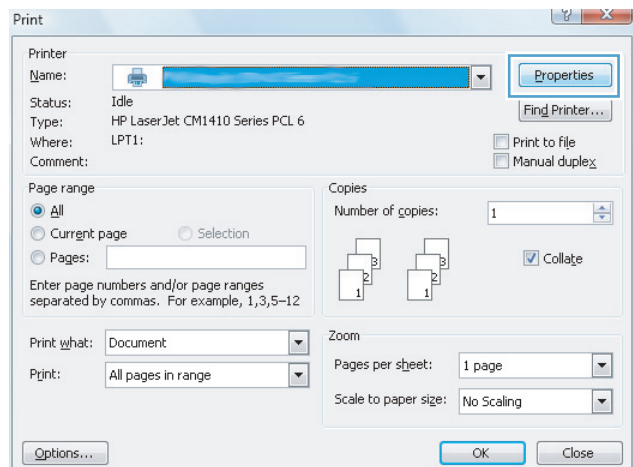

3. Click the **Finishing** tab.

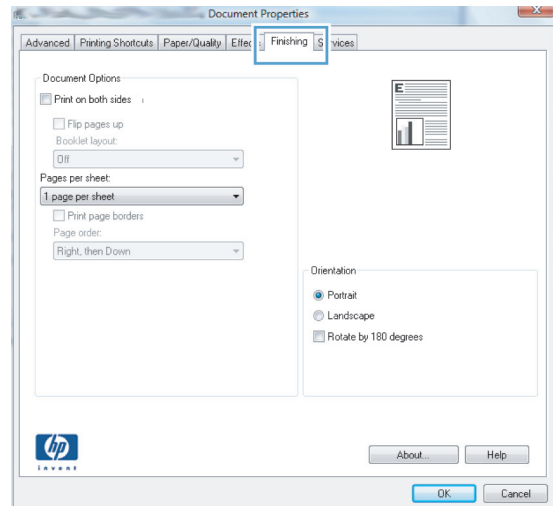

4. Select the number of pages per sheet from the **Pages per sheet** drop-down list.

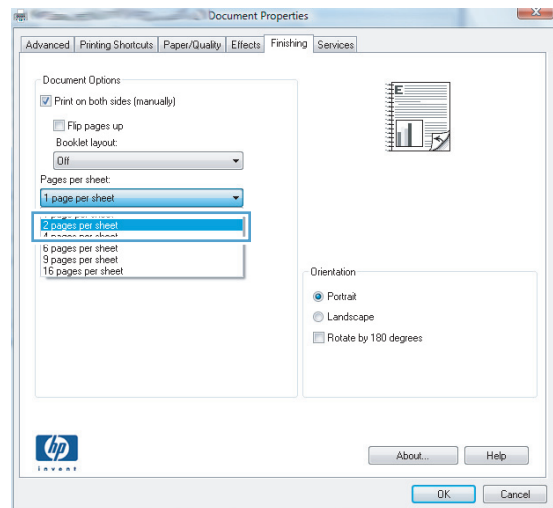

5. Select the correct **Print page borders**, **Page order**, and **Orientation** options.

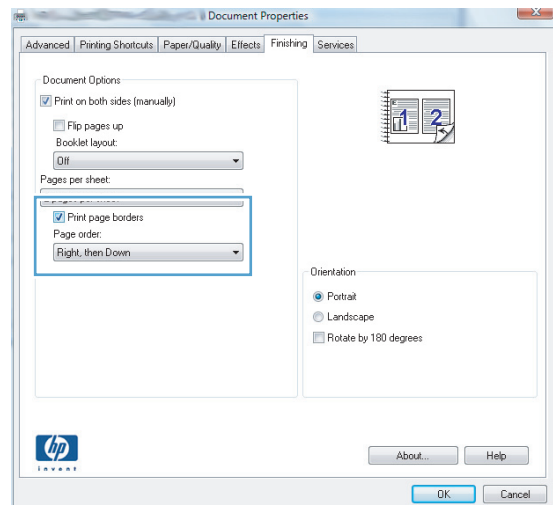

Select the page orientation (Windows)

1. From the software program, select the **Print** option.
2. Select the product, and then click the **Properties** or **Preferences** button.

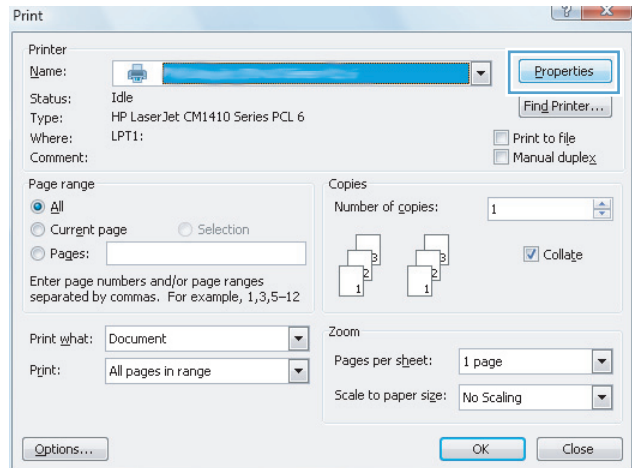

3. Click the **Finishing** tab.

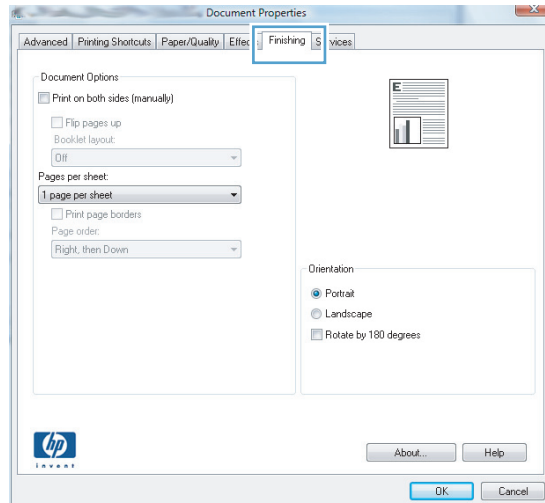

4. In the **Orientation** area, select the **Portrait** or **Landscape** option.

To print the page image upside down, select the **Rotate by 180 degrees** option.

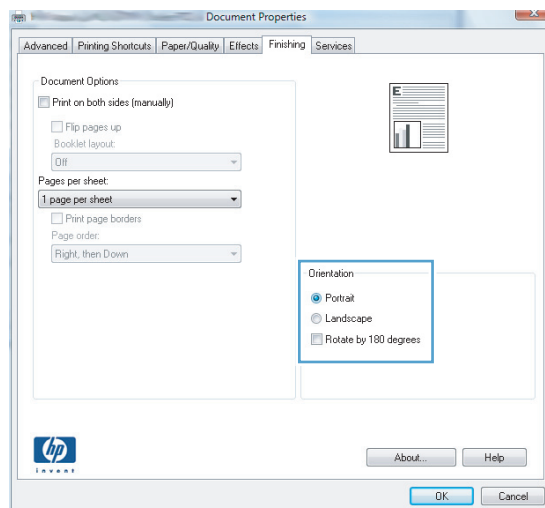

Select the paper type (Windows)

1. From the software program, select the **Print** option.
2. Select the product, and then click the **Properties** or **Preferences** button.

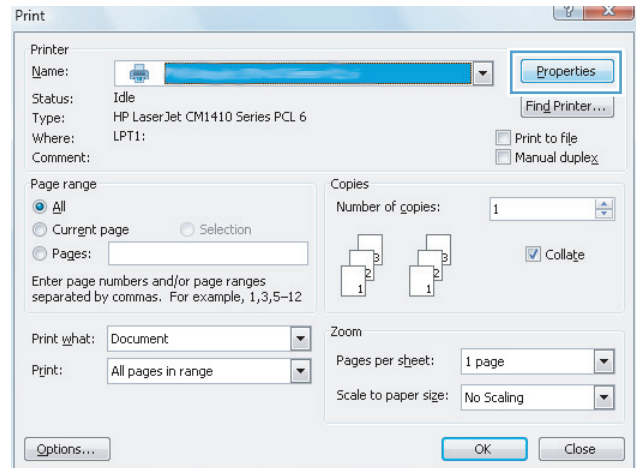

3. Click the **Paper/Quality** tab.

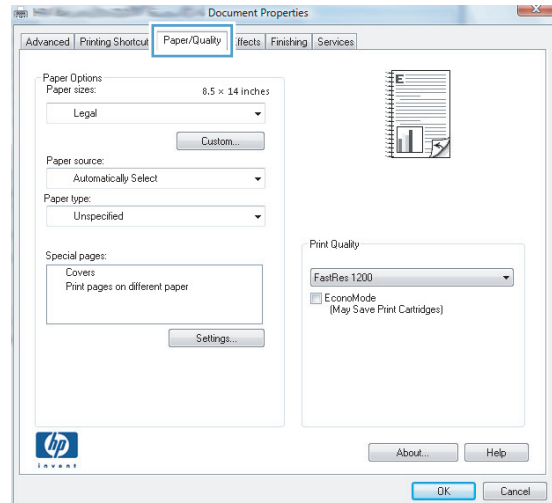

4. From the **Paper type** drop-down list, click the **More...** option.

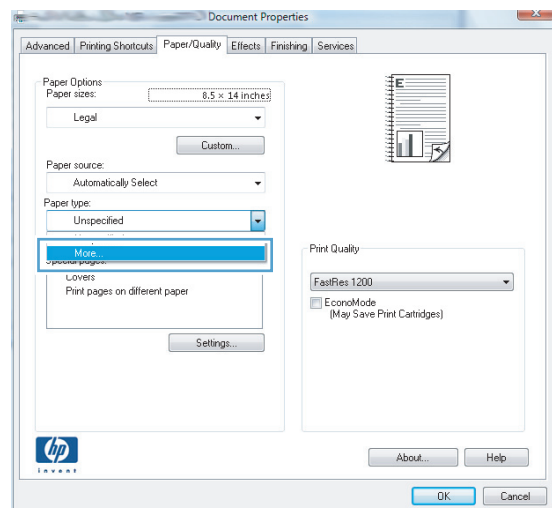

5. Select the category of paper types that best describes your paper.

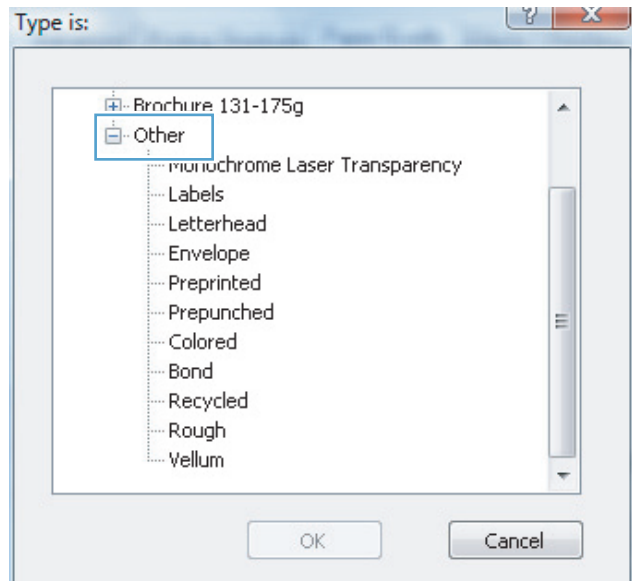

6. Select the option for the type of paper you are using, and click the **OK** button.

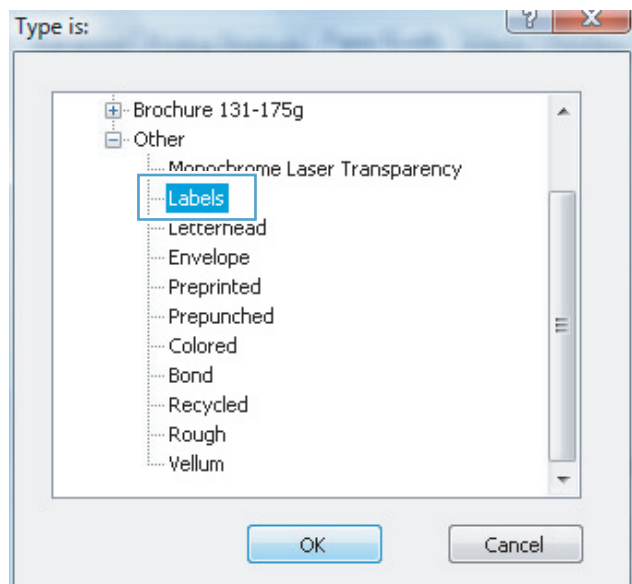

Print the first or last page on different paper (Windows)

1. From the software program, select the **Print** option.

2. Select the product, and then click the **Properties** or **Preferences** button.

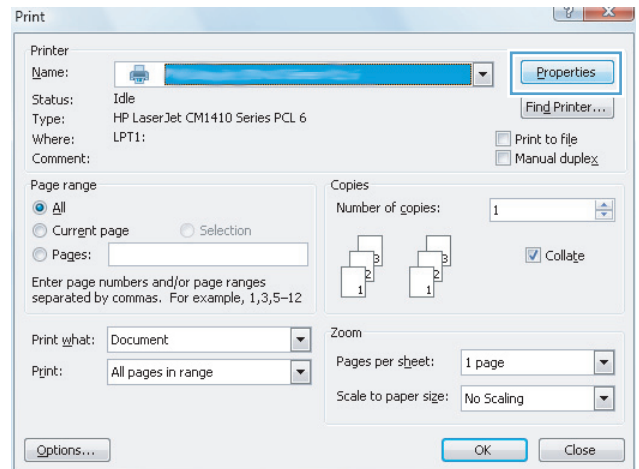

3. Click the **Paper/Quality** tab.

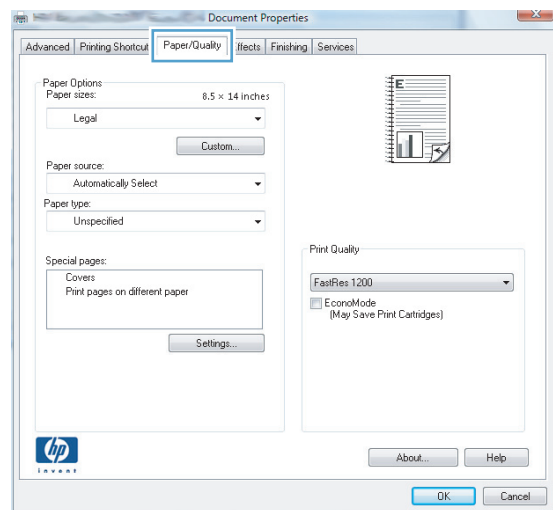

4. Click the **Print pages on different paper** item, and then click the **Settings** button to select the necessary settings for the front cover, other pages, and back cover.

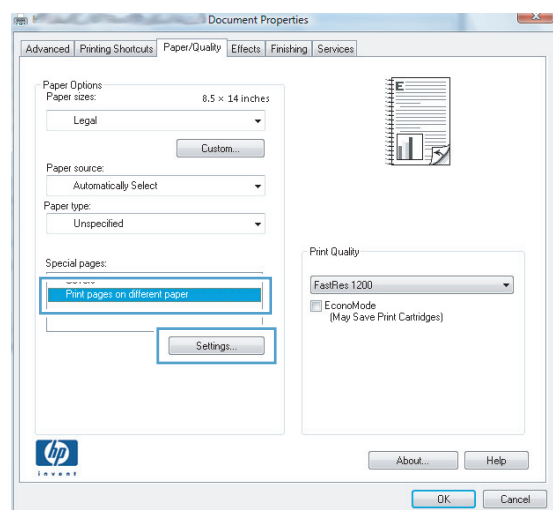

Scale a document to fit page size (Windows)

1. From the software program, select the **Print** option.
2. Select the product, and then click the **Properties** or **Preferences** button.

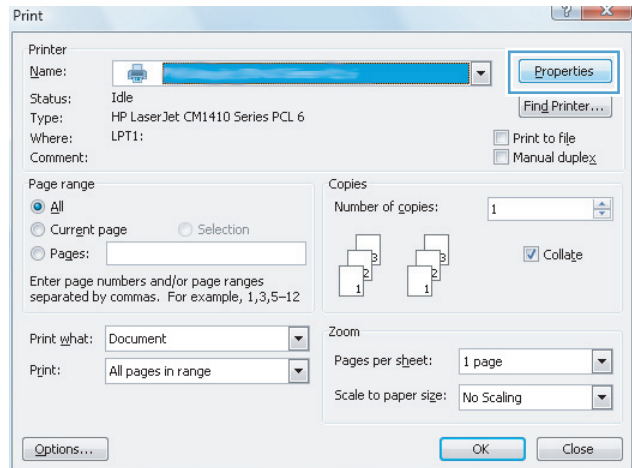

3. Click the **Effects** tab.

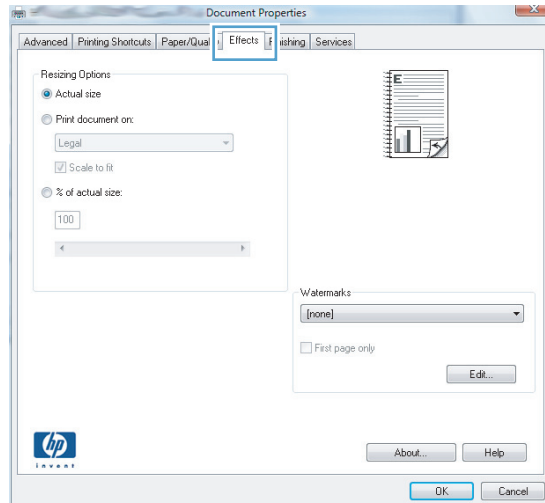

4. Select the **Print document on** option, and then select a size from the drop-down list.

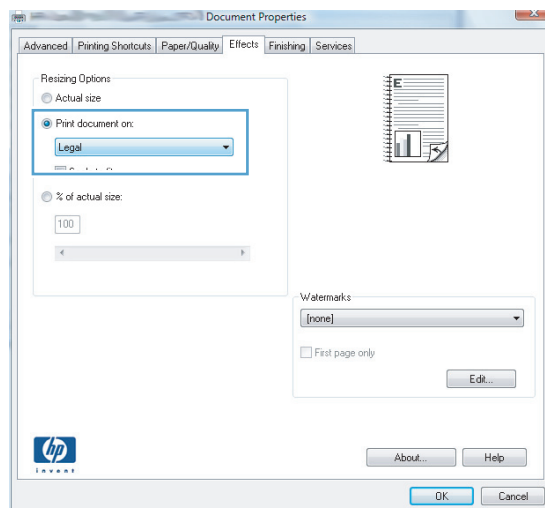

Create a booklet (Windows)

1. From the software program, select the **Print** option.
2. Select the product, and then click the **Properties** or **Preferences** button.

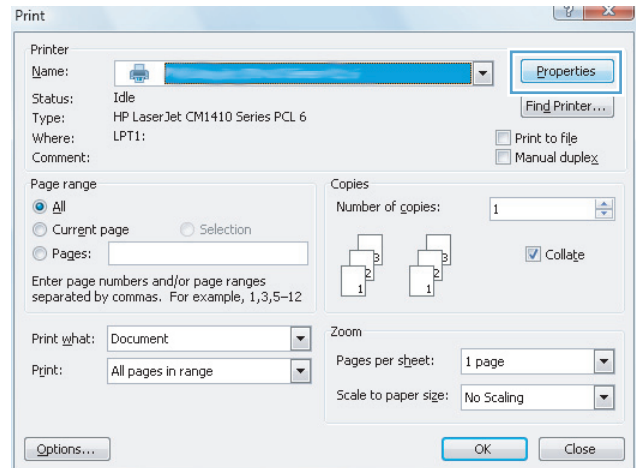

3. Click the **Finishing** tab.

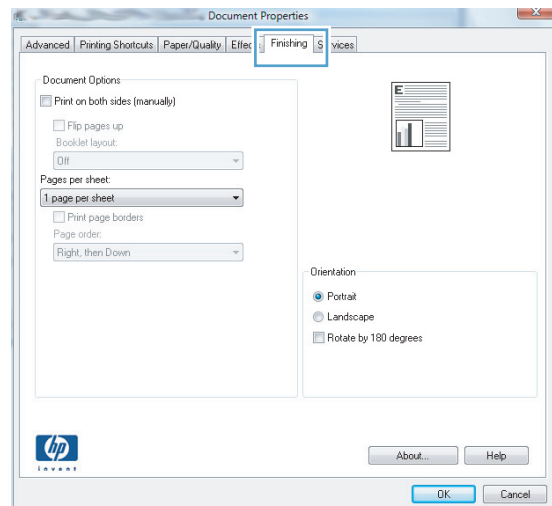

4. Click the **Print on both sides** or **Print on both sides (manually)** check box.

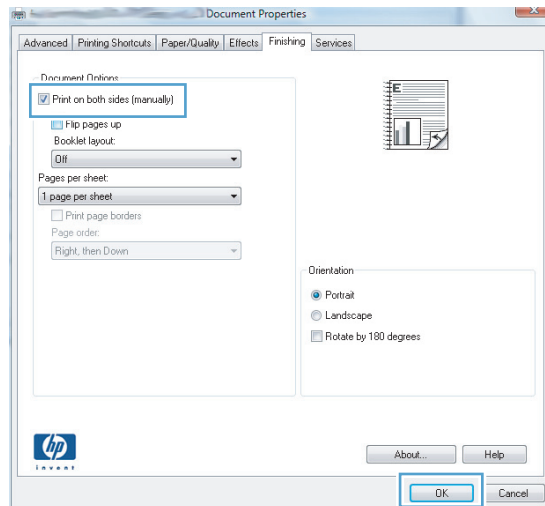

5. In the **Booklet layout** drop-down list, select a binding option. The **Pages per sheet** option automatically changes to **2 pages per sheet**.

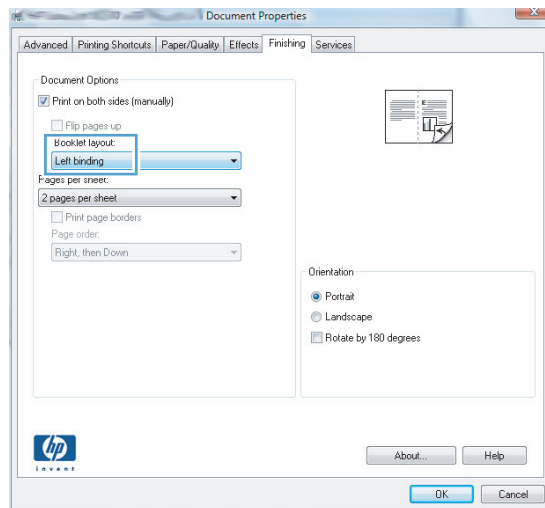

Print tasks for Mac OS X

Use a printing preset (Mac OS X)

1. On the **File** menu, click the **Print** option.
2. In the **Printer** menu, select this product.
3. In the **Presets** menu, select the printing preset.
4. Click the **Print** button.



NOTE: To use print driver default settings, select the **standard** option.

Create a printing preset (Mac OS X)

Use printing presets to save the current printer driver settings for reuse.

1. On the **File** menu, click the **Print** option.
2. In the **Printer** menu, select this product.
3. Select the print settings that you want to save for reuse.
4. In the **Presets** menu, click the **Save As...** option, and type a name for the preset.
5. Click the **OK** button.

Automatically print on both sides (Mac OS X)



NOTE: This section applies to the HP LaserJet Pro 400 M401d Printer, HP LaserJet Pro 400 M401dn Printer, and HP LaserJet Pro 400 M401dw Printer models only.

1. Insert enough paper into one of the trays to accommodate the print job.
2. On the **File** menu, click the **Print** option.
3. In the **Printer** drop-down list, select this product.
4. Select the **Layout** drop-down item.
5. From the **Two-Sided** drop-down list, select a binding option.
6. Click the **Print** button.

Manually print on both sides (Mac OS X)

 **NOTE:** This section primarily applies to the HP LaserJet Pro 400 M401a Printer and HP LaserJet Pro 400 M401n Printer models. However, the HP LaserJet Pro 400 M401d Printer, HP LaserJet Pro 400 M401dn Printer, and HP LaserJet Pro 400 M401dw Printer models also can print two-sided jobs manually if the paper is not supported by automatic two-sided printing, or if the duplex unit has been disabled.

1. Insert enough paper into Tray 1 to accommodate the print job.
2. On the **File** menu, click the **Print** option.
3. In the **Printer** drop-down list, select this product.
4. Select the **Manual Duplex** drop-down item.
5. Click the **Manual Duplex** box, and select a binding option.
6. Click the **Print** button. Follow the instructions in the pop-up window that appears on the computer screen before replacing the output stack in Tray 1 for printing the second half.
7. Go to the product, and remove any blank paper that is in Tray 1.
8. Insert the printed stack in Tray 1 with the printed side down and the top of the pages toward the product.

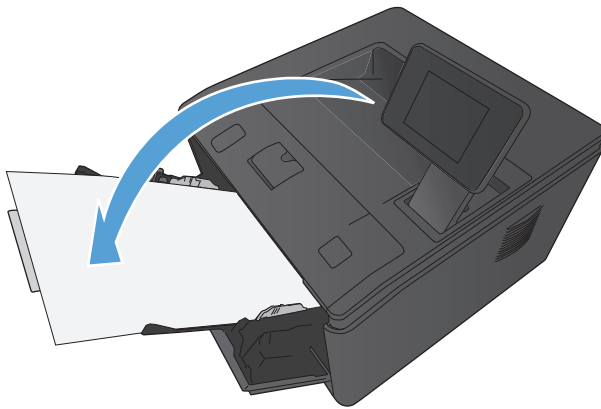

9. If prompted, touch the appropriate control panel button to continue.

Print multiple pages on one sheet of paper (Mac OS X)

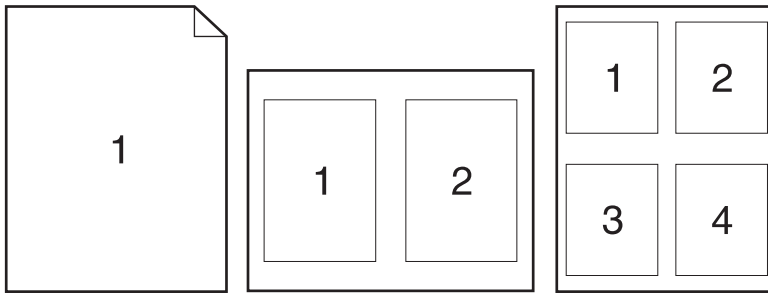

1. On the **File** menu, click the **Print** option.
2. In the **Printer** menu, select this product.
3. Open the **Layout** menu.
4. From the **Pages per Sheet** menu, select the number of pages that you want to print on each sheet (1, 2, 4, 6, 9, or 16).
5. In the **Layout Direction** area, select the order and placement of the pages on the sheet.
6. From the **Borders** menu, select the type of border to print around each page on the sheet.
7. Click the **Print** button.

Select the page orientation (Mac OS X)

1. On the **File** menu, click the **Print** option.
2. In the **Printer** menu, select this product.
3. In the **Copies & Pages** menu, click the **Page Setup** button.
4. Click the icon that represents the page orientation that you want to use, and then click the **OK** button.
5. Click the **Print** button.

Select the paper type (Mac OS X)

1. On the **File** menu, click the **Print** option.
2. In the **Printer** menu, select this product.
3. Open the **Finishing** menu.

4. Select a type from the **Media-type** drop-down list.
5. Click the **Print** button.

Print a cover page (Mac OS X)

1. On the **File** menu, click the **Print** option.
2. In the **Printer** menu, select this product.
3. Open the **Cover Page** menu, and then select where to print the cover page. Click either the **Before Document** button or the **After Document** button.
4. In the **Cover Page Type** menu, select the message that you want to print on the cover page.



NOTE: To print a blank cover page, select the **standard** option from the **Cover Page Type** menu.

5. Click the **Print** button.

Scale a document to fit page size (Mac OS X)

1. On the **File** menu, click the **Print** option.
2. In the **Printer** menu, select this product.
3. Open the **Paper Handling** menu.
4. In the **Destination Paper Size** area, click the **Scale to fit paper size** box, and then select the size from the drop-down list.
5. Click the **Print** button.

Create a booklet (Mac OS X)

1. On the **File** menu, click the **Print** option.
2. In the **Printer** menu, select this product.
3. Open the **Manual Duplex** menu.
4. Click the **Manual Duplex** box.
5. Open the **Booklet Printing** menu.
6. Click the **Format Output as Booklet** box, and select a binding option.
7. Select the paper size.
8. Click the **Print** button.

Additional print tasks (Windows)

Cancel a print job (Windows)

1. If the print job is currently printing, cancel it by pressing the Cancel **X** button on the product control panel.

 **NOTE:** Pressing the Cancel **X** button clears the job that the product is currently processing. If more than one process is running, pressing the Cancel **X** button clears the process that currently appears on the product control panel.

2. You can also cancel a print job from a software program or a print queue.
 - **Software program:** Typically, a dialog box appears briefly on the computer screen, allowing you to cancel the print job.
 - **Windows print queue:** If a print job is waiting in a print queue (computer memory) or print spooler, delete the job there.
 - **Windows XP, Server 2003, or Server 2008:** Click **Start**, click **Settings**, and then click **Printers and Faxes**. Double-click the product icon to open the window, right-click the print job that you want to cancel, and then click **Cancel**.
 - **Windows Vista:** Click **Start**, click **Control Panel**, and then, under **Hardware and Sound**, click **Printer**. Double-click the product icon to open the window, right-click the print job that you want to cancel, and then click **Cancel**.
 - **Windows 7:** Click **Start**, and then click **Devices and Printers**. Double-click the product icon to open the window, right-click the print job that you want to cancel, and then click **Cancel**.

Select the paper size (Windows)

1. From the software program, select the **Print** option.
2. Select the product, and then click the **Properties** or **Preferences** button.
3. Click the **Paper/Quality** tab.
4. Select a size from the **Paper size** drop-down list.

Select a custom paper size (Windows)

1. From the software program, select the **Print** option.
2. Select the product, and then click the **Properties** or **Preferences** button.
3. Click the **Paper/Quality** tab.
4. Click the **Custom** button.

5. Type a name for the custom size and specify the dimensions.
 - The width is the short edge of the paper.
 - The length is the long edge of the paper.

 **NOTE:** Always load paper into the trays short edge first.

6. Click the **Save** button, and then click the **Close** button.

Print watermarks (Windows)

1. From the software program, select the **Print** option.
2. Select the product, and then click the **Properties** or **Preferences** button.
3. Click the **Effects** tab.
4. Select a watermark from the **Watermarks** drop-down list.

Or, to add a new watermark to the list, click the **Edit** button. Specify the settings for the watermark, and then click the **OK** button.
5. To print the watermark on the first page only, select the **First page only** check box. Otherwise, the watermark is printed on each page.

Additional print tasks (Mac OS X)

Cancel a print job (Mac OS X)

1. If the print job is currently printing, cancel it by pressing the Cancel **X** button on the product control panel.

 **NOTE:** Pressing the Cancel **X** button clears the job that the product is currently processing. If more than one print job is waiting, pressing the Cancel **X** button clears the print job that currently appears on the product control panel.

2. You can also cancel a print job from a software program or a print queue.
 - **Software program:** Typically, a dialog box appears briefly on the computer screen, allowing you to cancel the print job.
 - **Mac print queue:** Open the print queue by double-clicking the product icon in the dock. Highlight the print job, and then click **Delete**.

Select the paper size (Mac OS X)

1. On the **File** menu, click the **Print** option.
2. In the **Printer** menu, select this product.
3. In the **Copies & Pages** menu, click the **Page Setup** button.
4. Select a size from the **Paper Size** drop-down list, and then click the **OK** button.
5. Click the **Print** button.

Select a custom paper size (Mac OS X)

1. On the **File** menu, click the **Print** option.
2. In the **Printer** menu, select this product.
3. In the **Copies & Pages** menu, click the **Page Setup** button.
4. From the **Paper Size** drop-down list, select the **Manage Custom Sizes** option.
5. Specify the dimensions for the page size, and then click the **OK** button.
6. Click the **Print** button.

Print watermarks (Mac OS X)

1. On the **File** menu, click the **Print** option.
2. In the **Printer** menu, select this product.
3. Open the **Watermarks** menu.

4. Click the **Watermark** check box.
5. Beneath the check box, use the drop-down lists to set the various watermark elements.
6. Click the **Print** button.

Create archival-quality prints

Archive print produces output that is less susceptible to toner smearing and dusting. Use archive print to create documents that you want to preserve or archive.

 **NOTE:** Archival-quality printing is accomplished by increasing the temperature of the fuser. Because of the increased temperatures, the product prints at half-speed to avoid damage.

Create archival-quality prints (LCD control panel)

1. On the product control panel, press the **OK** button to open the menus.
2. Open the following menus:
 - **Service**
 - **Archive Print**
3. Select the **On** option, and then press the **OK** button.

Create archival-quality prints (touchscreen control panel)

1. From the Home screen on the product control panel, touch the Setup  button.
2. Touch the **Service** menu.
3. Touch the **Archive Print** button, and then touch the **On** button.

Use HP ePrint

Use HP ePrint to print documents by sending them as an email attachment to the product's email address from any email enabled device.



NOTE: The product must be connected to a wired or wireless network and have Internet access to use HP ePrint. HP ePrint is not available with the HP LaserJet Pro 400 M401d Printer.

Set up HP ePrint (LCD control panel)

1. To use HP ePrint, you must first enable HP Web Services.
 - a. On the product control panel, press the **OK** button to open the menus.
 - b. Select the **HP Web Services** menu, and then press the **OK** button.
 - c. Select the **Enable Web Services** option, and then press the **OK** button.

When the Web Services option is enabled, the product prints an information sheet that includes the product code and instructions to sign up at www.eprintcenter.com.

2. Once you have registered the product, use the HP ePrintCenter Web site to define security settings and to configure default print settings for all HP ePrint jobs sent to this product.
 - a. Go to www.hpeprintcenter.com.
 - b. Click **Sign In**, and enter your HP ePrintCenter credentials or sign up for a new account.
 - c. Select your product from the list, or click **+ Add printer** to add it. To add the product, you need the printer code, which is the segment of the product email address that is before the @ symbol. You can get this code by printing the Web Services page from the product control panel.

After you have added your product, you will have the option to customize the product email address.



NOTE: This code is valid for only 24 hours from the time you enable HP Web Services. If it expires, follow the instructions to enable HP Web Services again, and obtain a new code.

- d. To prevent your product from printing unexpected documents, click **ePrint Settings**, and then click the **Allowed Senders** tab. Click **Allowed Senders Only**, and add the email addresses from which you want to allow ePrint jobs.
 - e. To set up default settings for all ePrint jobs sent to this product, click **ePrint Settings**, click **Print Options**, and select the settings that you want to use.
3. To print a document, attach it to an email message sent to the product's email address. Both the email message and the attachment will print.

Set up HP ePrint (touchscreen control panel)

1. To use HP ePrint, you must first enable HP Web Services.
 - a. From the Home screen on the product control panel, touch the Web Services  button.
 - b. Touch the **Enable Web Services** button.
2. From the **HP Web Services** menu, touch the **Display E-Mail Address** button to display the product's email address on the control panel.
3. Use the HP ePrintCenter Web site to define security settings and to configure default print settings for all HP ePrint jobs sent to this product.
 - a. Go to www.hpeprintcenter.com.
 - b. Click **Sign In**, and enter your HP ePrintCenter credentials or sign up for a new account.
 - c. Select your product from the list, or click **+ Add printer** to add it. To add the product, you need the printer code, which is the segment of the product email address that is before the @ symbol. You can get this code by printing the Web Services page from the product control panel.

After you have added your product, you will have the option to customize the product email address.

 **NOTE:** This code is valid for only 24 hours from the time you enable HP Web Services. If it expires, follow the instructions to enable HP Web Services again, and obtain a new code.

- d. To prevent your product from printing unexpected documents, click **ePrint Settings**, and then click the **Allowed Senders** tab. Click **Allowed Senders Only**, and add the email addresses from which you want to allow ePrint jobs.
 - e. To set up default settings for all ePrint jobs sent to this product, click **ePrint Settings**, click **Print Options**, and select the settings that you want to use.
4. To print a document, attach it to an email message sent to the product's email address. Both the email message and the attachment will print.

Use AirPrint

Direct printing using Apple's AirPrint is supported for iOS 4.2 or later. Use AirPrint to print directly to the product from an iPad (iOS 4.2), iPhone (3GS or later), or iPod touch (third generation or later) in the following applications:

- Mail
- Photos
- Safari
- Select third-party applications

To use AirPrint, the product must be connected to a network, or be connected through a wireless direct connection. For more information about using AirPrint and about which HP products are compatible with AirPrint, go to www.hp.com/go/airprint.



NOTE: You might need to upgrade the product firmware to use AirPrint. Go to www.hp.com/support/ljm401series.

Walk-up USB printing

The HP LaserJet Pro 400 M401dn Printer and HP LaserJet Pro 400 M401dw Printer models feature printing from a USB flash drive, so that you can quickly print files without sending them from a computer. These products accept standard USB storage accessories in the USB port on the front of the products. You can print the following types of files:

- .PDF
- .JPEG

1. Insert the USB drive into the USB port on the front of the product.

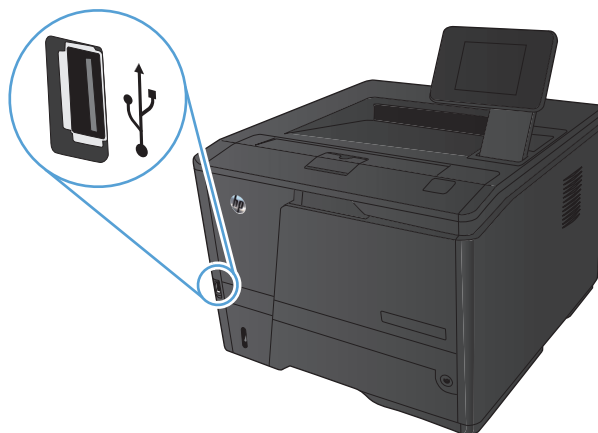

2. The **USB Flash Drive** menu opens. Touch the arrow buttons to scroll through the options.
 - **Print Documents**
 - **View and Print Photos**
 - **Scan to USB Drive**
3. To print a document, touch the **Print Documents** screen, and then touch the name of the folder on the USB drive where the document is stored. When the summary screen opens, you can touch it to adjust the settings. Touch the **Print** button to print the document.
4. To print photos, touch the **View and Print Photos** screen, and then touch the preview image for each photo that you want to print. Touch the **Done** button. When the summary screen opens, you can touch it to adjust the settings. Touch the **Print** button to print the photos.
5. Retrieve the printed job from the output bin, and remove the USB drive.

4 Manage and maintain

- [Use the HP Reconfiguration Utility to change the product connection](#)
- [Set up HP Wireless Direct Printing](#)
- [Use HP Web Services applications](#)
- [Configure IP network settings](#)
- [HP Device Toolbox \(Windows\)](#)
- [HP Utility for Mac OS X](#)
- [HP Web Jetadmin](#)
- [Product security features](#)
- [Economy settings](#)
- [Print when a toner cartridge is at estimated end of life](#)
- [Store and recycle supplies](#)
- [Replacement instructions](#)
- [Memory](#)
- [Update the firmware](#)

Use the HP Reconfiguration Utility to change the product connection

If you are already using the product and you wish to change the way it is connected, use the HP Reconfiguration Utility to set up the connection. For example, you can reconfigure the product to use a different wireless address, to connect to a wired or wireless network, or change from a network connection to a USB connection. You can change the configuration without inserting the product CD. After you select the type of connection you wish to make, the program goes directly to the portion of the product setup procedure that needs to change.

The HP Reconfiguration Utility is located in the HP programs group on your computer.

Set up HP Wireless Direct Printing

 **NOTE:** This feature is available with wireless models only.

The HP Wireless Direct Printing feature lets you print from your wireless mobile device directly to an HP Wireless Direct-enabled product without requiring connection to an established network or the Internet. Use HP Wireless Direct to print wirelessly from the following devices:

- iPhone, iPad, or iPod using Apple AirPrint
- Mobile devices that run Android, iOS, or Symbian using the HP ePrint Home & Biz application

To set up HP Wireless Direct from the control panel, complete the following steps:

1. From the Home screen on the product control panel, touch the Setup  button.
2. Open the following menus:
 - **Network Setup**
 - **Wireless Menu**
 - **Wireless Direct Settings**
 - **Wireless Direct On/Off**

 **NOTE:** If the **Wireless Direct Settings** item does not appear on the control panel, you need to upload the current version of the product firmware. To get the current version, go to www.hp.com, enter the HP product number in the search box, select the specific product model, and then click the **Software & Driver Downloads** link.

3. Touch the **On** menu item. The product saves the setting and then returns the control panel to the **Wireless Direct Settings** menu.

Use HP Web Services applications

Several innovative applications are available for this product that you can download directly from the Internet. For more information and to download these applications go to the HP ePrintCenter Web site at www.hpeprintcenter.com.

To use this feature, the product must be connected to a computer or network that has an Internet connection. HP Web Services must be enabled on the product. Follow this procedure to enable HP Web Services:

Use HP Web Services applications (LCD control panel)

1. On the control panel, press the **OK** button.
2. Select the **HP Web Services** menu, and then press the **OK** button.

After you download an application from the HP ePrintCenter Web site, it is available in the **Apps** menu on the product control panel.

Use HP Web Services applications (touchscreen control panel)

1. From the Home screen on the product control panel, touch the Web Services  button.
2. Touch the **Enable Web Services** button.

After you download an application from the HP ePrintCenter Web site, it is available in the **Apps** menu on the product control panel.

Configure IP network settings

View or change network settings

Use the **HP Device Toolbox** to view or change IP configuration settings.

1. Print a configuration page, and locate the IP address.
 - If you are using IPv4, the IP address contains only digits. It has this format:
`xxx . xxx . xxx . xxx`
 - If you are using IPv6, the IP address is a hexadecimal combination of characters and digits. It has a format similar to this:
`xxxx : : xxxx : xxxx : xxxx : xxxx`
2. Open the **HP Device Toolbox** by clicking the **Start** button, clicking the **Programs** or **All Programs** group, clicking **HP**, clicking the product group, and then clicking **HP Product Settings**.
3. Click the **Networking** tab to obtain network information. You can change settings as needed.

Manually configure IPv4 TCP/IP parameters from the control panel

Manually configure IPv4 TCP/IP parameters (LCD control panel)

1. On the control panel, press the **OK** button.
2. Use the arrow buttons to select the **Network Setup** option, and then press the **OK** button.
3. Use the arrow buttons to select the **TCP/IP configuration** option, and then press the **OK** button.
4. Use the arrow buttons to select the **Manual** option, and then press the **OK** button.
5. Use the alphanumeric buttons to type the IP address, and then press the **OK** button.
6. If the IP address is incorrect, use the arrow buttons to select the **No** option, and then press the **OK** button. Repeat step 5 with the correct IP address, and then repeat step 5 for the subnet mask and default gateway settings.

Manually configure IPv4 TCP/IP parameters (touchscreen control panel)

Use the control-panel menus to manually set an IPv4 address, subnet mask, and default gateway.

1. From the Home screen on the product control panel, touch the Setup  button.
2. Scroll to and touch the **Network Setup** menu.
3. Touch the **TCP/IP Config** menu, and then touch the **Manual** button.
4. Use the numeric keypad to enter the IP address, and touch the **OK** button. Touch the **Yes** button to confirm.

5. Use the numeric keypad to enter the subnet mask, and touch the **OK** button. Touch the **Yes** button to confirm.
6. Use the numeric keypad to enter the default gateway, and touch the **OK** button. Touch the **Yes** button to confirm.

Rename the product on a network

If you want to rename the product on a network so that it can be uniquely identified, use the HP Embedded Web Server.

1. To open the HP Embedded Web Server, type the product IP address into the address line of a Web browser.



NOTE: You can also access the HP Embedded Web Server from the HP Device Toolbox for Windows or the HP Utility for Mac OS X.

2. Open the **System** tab.
3. On the **Device Information** page, the default product name is in the **Device Status** field. You can change this name to uniquely identify this product.



NOTE: Completing the other fields on this page is optional.

4. Click the **Apply** button to save the changes.

Link speed and duplex settings

 **NOTE:** This information applies only to Ethernet networks. It does not apply to wireless networks.

The link speed and communication mode of the print server must match the network hub. For most situations, leave the product in automatic mode. Incorrect changes to the link speed and duplex settings might prevent the product from communicating with other network devices. If you need to make changes, use the product control panel.

 **NOTE:** The setting must match with the network product to which you are connecting (a network hub, switch, gateway, router, or computer).

 **NOTE:** Making changes to these settings causes the product to turn off and then on. Make changes only when the product is idle.

Link speed and duplex settings (LCD control panel)

1. On the control panel, press the **OK** button.
2. Use the arrow buttons to select the **Network Setup** option, and then press the **OK** button.
3. Use the arrow buttons to select the **Link Speed** option, and then press the **OK** button.
4. Use the arrow buttons to select one of the following settings.

Setting	Description
Automatic	The print server automatically configures itself for the highest link speed and communication mode allowed on the network.
10T Full	10 Mbps, full-duplex operation
10T Half	10 megabytes per second (Mbps), half-duplex operation
100TX Full	100 Mbps, full-duplex operation
100TX Half	100 Mbps, half-duplex operation

5. Press the **OK** button. The product turns off and then on.

Link speed and duplex settings (touchscreen control panel)

1. On the Home screen, touch the Setup  button.
2. Scroll to and touch the **Network Setup** menu.
3. Touch the **Link Speed** menu.
4. Select one of the following options.

Setting	Description
Automatic	The print server automatically configures itself for the highest link speed and communication mode allowed on the network.

Setting	Description
10T Full	10 Mbps, full-duplex operation
10T Half	10 megabytes per second (Mbps), half-duplex operation
100TX Full	100 Mbps, full-duplex operation
100TX Half	100 Mbps, half-duplex operation

5. Touch the **OK** button. The product turns off and then on.

HP Device Toolbox (Windows)

Use the HP Device Toolbox for Windows to view or change product settings from your computer. This tool opens the HP Embedded Web Server for the product.



NOTE: This tool is available only if you performed a full installation when you installed the product.

1. Click the **Start** button, and then click the **Programs** item.
2. Click your HP product group, and then click the **HP Device Toolbox** item.

Tab or section	Description
Home tab Provides product, status, and configuration information.	<ul style="list-style-type: none">• Device Status: Shows the product status and shows the approximate percent life remaining of HP supplies.• Supplies Status: Shows the approximate percent life remaining of HP supplies. Actual supply life remaining can vary. Consider having a replacement supply available to install when print quality is no longer acceptable. The supply does not need to be replaced unless the print quality is no longer acceptable.• Device Configuration: Shows the information found on the product configuration page.• Network Summary: Shows the information found on the product network configuration page.• Reports: Allows you to print the configuration and supplies status pages that the product generates.• Event Log: Shows a list of all product events and errors.
System tab Provides the ability to configure the product from your computer.	<ul style="list-style-type: none">• Device Information: Provides basic product and company information.• Paper Setup: Allows you to change the paper-handling defaults for the product.• Print Quality: Allows you to change the print quality defaults for the product, including calibration settings.• Paper Types: Allows you to configure print modes that correspond to the paper types that the product accepts.• System Setup: Allows you to change the system defaults for the product.• Service: Allows you to start the cleaning procedure on the product.• Product Security: Allows you to set or change the product password.• Save and Restore: Save the current settings for the product to a file on the computer. Use this file to load the same settings onto another product or to restore these settings to this product at a later time. <p>NOTE: The System tab can be password-protected. If this product is on a network, always consult with the administrator before changing settings on this tab.</p>

Tab or section	Description
<p>Print tab</p> <p>Provides the ability to change default print settings from your computer.</p>	<ul style="list-style-type: none"> • Printing: Change the default product print settings, such as number of copies and paper orientation. These are the same options that are available on the control panel. • PCL5c: View and change the PCL5c settings. • PostScript: Turn off or on the Print PS Errors feature.
<p>Networking tab</p> <p>Provides the ability to change network settings from your computer.</p>	<p>Network administrators can use this tab to control network-related settings for the product when it is connected to an IP-based network. It also allows the network administrator to set up wireless direct functionality. This tab does not appear if the product is directly connected to a computer.</p>
<p>HP Web Services tab</p>	<p>Use this tab to set up and use various Web tools with the product.</p>
<p>HP Smart Install tab</p>	<p>Use this tab to download and install the print driver.</p>

HP Utility for Mac OS X

Use the HP Utility for Mac OS X to view or change product settings from your computer. This tool opens the HP Embedded Web Server for the product.

You can use the HP Utility when the product is connected with a USB cable or is connected to a TCP/IP-based network.

Open the HP Utility

▲ From the dock, click **HP Utility**.

-or-

From **Applications**, click **Hewlett Packard**, and then click **HP Utility**.

HP Utility features

Use the HP Utility software to perform the following tasks:

- Obtain information about supplies status.
- Obtain information about the product, such as the firmware version and the serial number.
- Print a configuration page.
- Configure the paper type and size for the tray.
- Transfer files and fonts from the computer to the product.
- Update the product firmware.
- Change the Bonjour name for the product on the Bonjour network.

HP Web Jetadmin

HP Web Jetadmin is an award-winning, industry-leading tool for efficiently managing a wide variety of networked HP devices, including printers, multifunction products, and digital senders. This single solution allows you to remotely install, monitor, maintain, troubleshoot, and secure your printing and imaging environment — ultimately increasing business productivity by helping you save time, control costs, and protect your investment.

HP Web Jetadmin updates are periodically made available to provide support for specific product features. Visit www.hp.com/go/webjetadmin and click the **Self Help and Documentation** link to learn more about updates.

 **NOTE:** Device plug-ins can be installed into HP Web Jetadmin to provide support for specific product features.

 **NOTE:** Browsers must be Java-enabled. Web Jetadmin is not supported for Mac OS X.

Product security features

The product supports security standards and recommended protocols that help you keep the product secure, protect critical information on your network, and simplify the way you monitor and maintain the product.

For in-depth information about HP's secure imaging and printing solutions, visit www.hp.com/go/secureprinting. The site provides links to white papers and FAQ documents about security features.

Lock the product

1. You can attach a security cable to the slot on the back of the product.

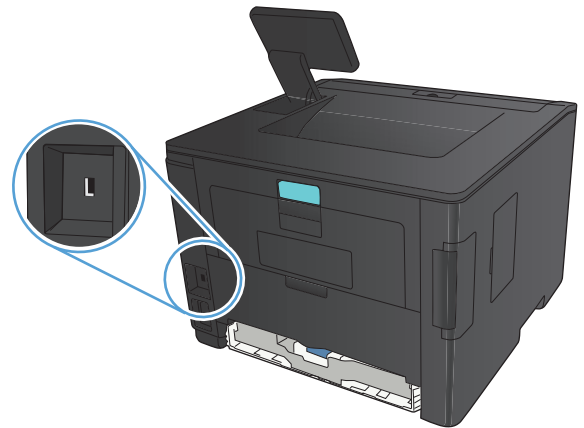

Set or change the product password

Use the HP Embedded Web Server to set a password or change an existing password for a product on a network.

1. **LED control panel:** Print a configuration page from the control panel **Reports** menu.

Touchscreen control panel: From the Home screen on the product control panel, touch the Network  button to find the product IP address.

2. To open the HP Embedded Web Server, type the product IP address into the address line of a Web browser.

 **NOTE:** You can also access the HP Embedded Web Server from the HP Device Toolbox for Windows or the HP Utility for Mac OS X.

3. Click the **Settings** tab, and click the **Security** link.

 **NOTE:** If a password has previously been set, you are prompted to type the password. Type the password, and then click the **Apply** button.

4. Type the new password in the **New Password** box and in the **Verify password** box.
5. At the bottom of the window, click the **Apply** button to save the password.

Economy settings

Print with EconoMode

This product has an EconoMode option for printing drafts of documents. Using EconoMode can use less toner and decrease the cost per page. However, using EconoMode can also reduce print quality.

HP does not recommend the full-time use of EconoMode. If EconoMode is used full-time, the toner supply might outlast the mechanical parts in the toner cartridge. If print quality begins to degrade and is no longer acceptable, consider replacing the toner cartridge.

 **NOTE:** If this option is not available in your print driver, you can set it using the HP Embedded Web Server.

1. From the software program, select the **Print** option.
2. Select the product, and then click the **Properties** or **Preferences** button.
3. Click the **Paper/Quality** tab.
4. Click the **EconoMode** check box.

Set the sleep delay

The sleep delay feature determines how long the product must be inactive before it switches to sleep mode to reduce power consumption.

Set the sleep delay (LCD control panel)

1. On the product control panel, press the **OK** button to open the menus.
2. Open the following menus:
 - **System Setup**
 - **Energy Settings**
 - **Sleep Delay**
3. Select the time for the delay, and then press the **OK** button.

 **NOTE:** The default value is **15 Minutes**.

Set the sleep delay (touchscreen control panel)

1. From the Home screen on the product control panel, touch the Setup  button.
2. Open the following menus:
 - **System Setup**
 - **Energy Settings**
 - **Sleep Delay**
3. Select the time for the sleep delay.

 **NOTE:** The default value is **15 Minutes**.

Set the Auto Power Down delay

Set the Auto Power Down delay (LCD control panel)

1. On the product control panel, press the **OK** button to open the menus.
2. Open the following menus:
 - **System Setup**
 - **Energy Settings**
 - **Auto Power Down**
 - **Auto Power Down Delay**
3. Select the time for the power-down delay.

 **NOTE:** The default value is **30 Minutes**.

4. The product automatically wakes from the auto power-down mode when it receives jobs or when you press a button on the control panel. You can change which events cause the product to wake. Open the following menus:
 - **System Setup**
 - **Energy Settings**
 - **Auto Power Down**
 - **Wake Events**

To turn off a wake event, select the event and then select the **No** option.

Set the Auto Power Down delay (touchscreen control panel)

1. From the Home screen on the product control panel, touch the Setup  button.
2. Open the following menus:
 - **System Setup**
 - **Energy Settings**
 - **Auto Power Down**
 - **Auto Power Down Delay**
3. Select the time for the power-down delay.

 **NOTE:** The default value is **30 Minutes**.

4. The product automatically wakes from the auto power-down mode when it receives jobs or when you press a button on the control panel. You can change which events cause the product to wake. Open the following menus:
 - **System Setup**
 - **Energy Settings**
 - **Auto Power Down**
 - **Wake Events**

To turn off a wake event, select the event and then select the **No** option.

Print when a toner cartridge is at estimated end of life

Black Low: The product indicates when a toner cartridge level is low. Actual toner cartridge life remaining may vary. Consider having a replacement available to install when print quality is no longer acceptable. The toner cartridge does not need to be replaced now.

Black Very Low: The product indicates when the toner cartridge level is very low. Actual toner cartridge life remaining may vary. Consider having a replacement available to install when print quality is no longer acceptable. The toner cartridge does not need to be replaced now unless the print quality is no longer acceptable.

Once an HP toner cartridge has reached "very low", HP's Premium Protection Warranty on that toner cartridge has ended.

You can change the way the product reacts when supplies reach the Very Low state. You do not have to re-establish these settings when you install a new toner cartridge.

Enable or disable the At Very Low settings (LCD control panel)

You can enable or disable the default setting at any time, and you do not have to re-enable it when you install a new toner cartridge.

1. On the product control panel, press the **OK** button to open the menus.
2. Open the following menus:
 - **System Setup**
 - **Supply Settings**
 - **Black Cartridge**
 - **Very Low Setting**
3. Select one of the following options.
 - Select the **Continue** option to set the product to alert you that the toner cartridge is very low, but to continue printing.
 - Select the **Stop** option to set the product to stop printing until you replace the toner cartridge.
 - Select the **Prompt** option to set the product to stop printing and prompt you to replace the toner cartridge. You can acknowledge the prompt and continue printing. A customer configurable option on this product is "Prompt to Remind Me in 100 pages, 200 pages, 300 pages, 400 pages, or never." This option is provided as a customer convenience and is not an indication these pages will have acceptable print quality.

Once an HP toner cartridge has reached **Very Low**, HP's premium Protection Warranty on that toner cartridge has ended.

Enable or disable the At Very Low settings (touchscreen control panel)

You can enable or disable the default settings at any time, and you do not have to re-enable them when you install a new toner cartridge.

1. From the Home screen on the product control panel, touch the Setup  button.
2. Open the following menus:
 - **System Setup**
 - **Supply Settings**
 - **Black Cartridge**
 - **Very Low Setting**
3. Select one of the following options:
 - Select the **Continue** option to set the product to alert you that the toner cartridge is very low, but to continue printing.
 - Select the **Stop** option to set the product to stop printing until you replace the toner cartridge.
 - Select the **Prompt** option to set the product to stop printing and prompt you to replace the toner cartridge. You can acknowledge the prompt and continue printing. A customer configurable option on this product is "Prompt to Remind Me in 100 pages, 200 pages, 300 pages, 400 pages, or never." This option is provided as a customer convenience and is not an indication these pages will have acceptable print quality.

Once an HP toner cartridge has reached **Very Low**, HP's premium Protection Warranty on that toner cartridge has ended. All print defects or cartridge failures incurred when an HP toner cartridge is used in **Continue** at very low mode will not be considered to be defects in materials or workmanship in the toner cartridge under the HP Print Cartridge Warranty Statement.

Store and recycle supplies

Recycle supplies

To recycle a genuine HP toner cartridge, place the used cartridge in the box in which the new cartridge arrived. Use the enclosed return label to send the used supply to HP for recycling. For complete information, see the recycling guide that is included with each new HP supply item.

Toner cartridge storage

Do not remove the toner cartridge from its package until you are ready to use it.

 **CAUTION:** To prevent damage to the toner cartridge, do not expose it to light for more than a few minutes.

Replacement instructions

Change the toner cartridge

When a toner cartridge approaches the end of useful life, you are prompted to order a replacement. You can continue printing with the current cartridge until redistributing the toner no longer yields acceptable print quality.

1. Open the toner cartridge door, and then remove the toner cartridge.

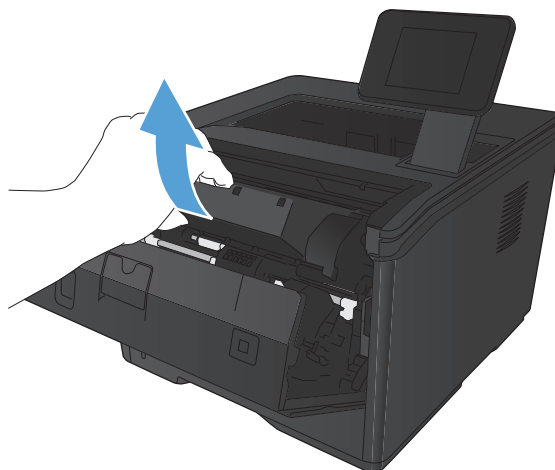

2. Remove the new toner cartridge from the bag. Place the used toner cartridge in the bag for recycling.

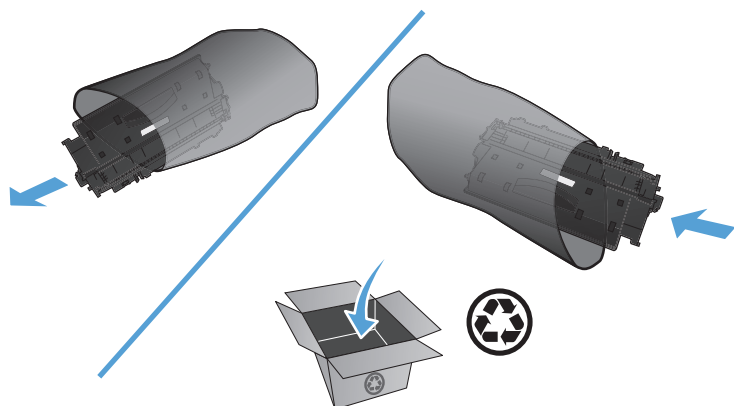

3. Grasp both sides of the toner cartridge and distribute the toner by gently rocking the cartridge.

CAUTION: Do not touch the shutter or the surface of the roller.

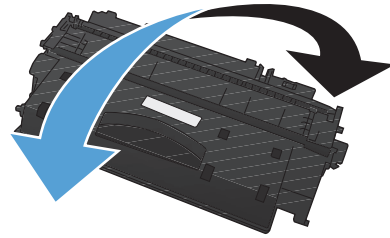

4. Bend the tab on the left side of the cartridge until the tab breaks loose. Pull the tab until all the tape is removed from the cartridge. Place the tab and tape in the toner cartridge box to return for recycling.

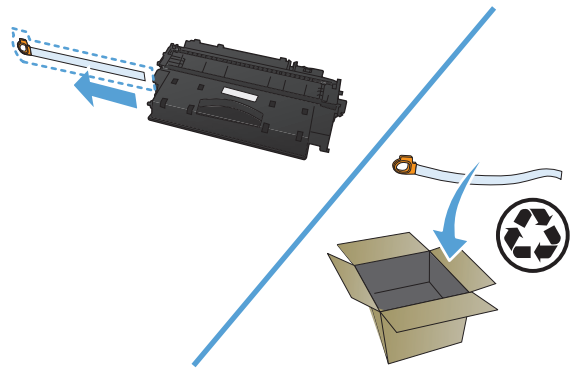

5. Align the toner cartridge with the tracks inside the product, insert the toner cartridge until it is firmly seated, and then close the toner cartridge door.

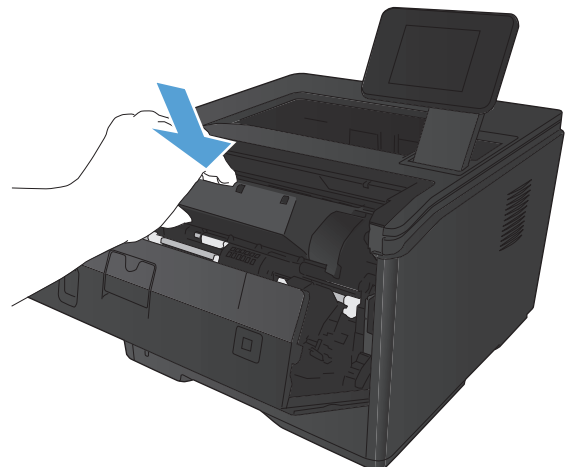

6. Installation is complete. Place the used toner cartridge in the box in which the new cartridge arrived. See the enclosed recycling guide for recycling instructions.

Memory

This product includes a memory panel that will accept the following third-party font and barcode memory modules. Hewlett-Packard does not sell these products.

- BarDIMM Pro, Jetmobile
- MicrDIMM Pro, Jetmobile
- TypeHaus Fonts and Barcodes Solutions, TypeHaus, Inc.
- Asian Fonts, JITCO, Ltd.
- BarDIMM® Box, Jetmobile
- BarSIMM 1.9, Jetmobile
- EIO Hard-Disk for LaserJet Series, Oberon Service SRL
- Ethernet to Token Ring Router (ETRR), Ringdale
- EuroForm Barcode 100, EuroForm A/S

Update the firmware

HP offers periodic upgrades to the product firmware. You can load the firmware updates manually, or you can set the product to automatically load firmware updates.

Manually update the firmware (LCD control panel)

1. On the product control panel, press the **OK** button to open the menus.
2. Open the following menus:
 - **Service**
 - **LaserJet Update**
 - **Check For Updates Now**
3. Select the **Yes** option, and then press the **OK** button to prompt the product to search for firmware updates. If the product detects an upgrade, it will begin the update process.

Manually update the firmware (touchscreen control panel)

1. From the Home screen on the product control panel, touch the Setup  button.
2. Open the following menus:
 - **Service**
 - **LaserJet Update**
 - **Check For Updates Now**
3. Touch the **Yes** button to prompt the product to search for firmware updates. If the product detects an upgrade, it will begin the update process.

Set the product to automatically update the firmware (LCD control panel)



NOTE: This section applies to the HP LaserJet Pro 400 M401a Printer model only.

1. On the product control panel, press the **OK** button to open the menus.
2. Open the following menus:
 - **Service**
 - **LaserJet Update**
 - **Manage Updates**
 - **Prompt Before Install**
3. Select the **Install Automatically** option, and then press the **OK** button.

Set the product to automatically update the firmware (touchscreen control panel)



NOTE: This section applies to the HP LaserJet Pro 400 M401d Printer model only.

1. From the Home screen on the product control panel, touch the Setup  button.
2. Open the following menus:
 - **Service**
 - **LaserJet Update**
 - **Manage Updates**
 - **Prompt Before Install**
3. Touch the **Install Automatically** option.

5 Solve problems

- [Solve problems checklist](#)
- [Restore the factory-set defaults](#)
- [Control panel help system](#)
- [Interpret control panel messages](#)
- [Paper feeds incorrectly or becomes jammed](#)
- [Clear jams](#)
- [Improve print quality](#)
- [The product does not print or it prints slowly](#)
- [Solve walk-up USB printing problems](#)
- [Solve direct connection problems](#)
- [Solve wired network problems](#)
- [Solve wireless network problems](#)
- [Solve product software problems with Windows](#)
- [Solve product software problems with Mac OS X](#)
- [Remove software \(Windows\)](#)
- [Remove software \(Mac OS X\)](#)

Solve problems checklist

Follow these steps when trying to solve a problem with the product.

- [Step 1: Make sure that the product is set up correctly](#)
- [Step 2: Check the cabling or wireless connection](#)
- [Step 3: Check the control panel for error messages](#)
- [Step 4: Check the paper](#)
- [Step 5: Check the software](#)
- [Step 6: Test print functionality](#)
- [Step 7: Check the toner cartridge](#)
- [Step 8: Try sending a print job from a computer](#)

Step 1: Make sure that the product is set up correctly

1. Press the power button to turn on the product or to deactivate the Auto Power Down mode.
2. Check the power-cable connections.
3. Make sure that the line voltage is correct for the product power configuration. (See the label on the back of the product for voltage requirements.) If you are using a power strip and its voltage is not within specifications, plug the product directly into the wall. If it is already plugged into the wall, try a different outlet.
4. If none of these measures restores power, contact HP Customer Care.

Step 2: Check the cabling or wireless connection

1. Check the cable connection between the product and the computer. Make sure that the connection is secure.
2. Make sure that the cable itself is not faulty by using a different cable, if possible.
3. If the product is connected to a network, check the following items:
 - Check the light next to the network connection on the product. If the network is active, the light is green.
 - Make sure that you are using a network cable and not a phone cord to connect to the network.
 - Make sure the network router, hub, or switch is turned on and that it is working correctly.
 - If your computer or the product is connected to a wireless network, low signal quality or interference might be delaying print jobs.
4. If you are using a personal firewall system on the computer, it might be blocking communication with the product. Try temporarily disabling the firewall to see if it is the source of the problem.

Step 3: Check the control panel for error messages

The product control panel should indicate ready status. If an error message appears, resolve the error.

Step 4: Check the paper

1. Make sure that the paper that you are using meets specifications.
2. Make sure that the paper is loaded correctly in the input tray.

Step 5: Check the software

1. Make sure that the product software is installed correctly.
2. Verify that you have installed the print driver for this product. Check the program to make sure that you are using the print driver for this product.

Step 6: Test print functionality

1. Print a configuration page.
2. If the page does not print, verify that the input tray contains paper.
3. If the page jams in the product, clear the jam.

Step 7: Check the toner cartridge

Print a supplies status page and check the remaining life of the toner cartridge.

Step 8: Try sending a print job from a computer

1. Try printing the job from another computer that has the product software installed.
2. Check the USB or network cable connection. Direct the product to the correct port, or reinstall the software, selecting the connection type that you are using.
3. If the print quality is unacceptable, verify that the print settings are correct for the media that you are using.

Restore the factory-set defaults

Restoring the factory-set defaults returns all of the product and network settings to the factory defaults. It will not reset the page count, tray size, or language. To restore the product to the factory-default settings, follow these steps.

⚠ CAUTION: Restoring the factory-set defaults returns all of the settings to the factory defaults, and it also deletes any pages that are stored in the memory. The procedure then automatically restarts the product.

Restore the factory-set defaults (LCD control panel)

1. On the product control panel, press the **OK** button to open the menus.
2. Open the following menus:
 - **Service**
 - **Restore Defaults**

The product automatically restarts.

Restore the factory-set defaults (touchscreen control panel)

1. From the Home screen on the product control panel, touch the Setup  button.
2. Scroll to and touch the **Service** menu.
3. Scroll to and touch the **Restore Defaults** button, and then touch the **OK** button.

The product automatically restarts.

Control panel help system

The HP LaserJet Pro 400 M401dn Printer and HP LaserJet Pro 400 M401dw Printer models have built-in Help systems that explain how to use each screen. To open the Help system, touch the Help ? button in the upper-right corner of the screen.

For some screens, the Help opens to a global menu where you can search for specific topics. You can browse through the menu structure by touching the buttons in the menu.

Some Help screens include animations that guide you through procedures, such as clearing jams.

For screens that contain settings for individual jobs, the Help opens to a topic that explains the options for that screen.

If the product alerts you of an error or warning, touch the Help ? button to open a message that describes the problem. The message also contains instructions to help solve the problem.

Interpret control panel messages

Control panel message types

The control panel messages indicate the current product status or situations that might require action.

Alert and warning messages appear temporarily and might require you to acknowledge the message by pressing the **OK** button to resume or by pressing the **Cancel** **X** button to cancel the job. With certain warnings, the job might not complete or the print quality might be affected. If the alert or warning message is related to printing and the auto-continue feature is on, the product will attempt to resume the printing job after the warning has appeared for 10 seconds without acknowledgement.

Critical error messages can indicate some kind of failure. Turning off and then turning on the power might fix the problem. If a critical error persists, the product might require service.

Control panel messages

10.x000 Supply Error

Description

The toner cartridge memory chip cannot be read or is missing.

- 10.0000 = memory chip error
- 10.1000 = memory chip is missing

Recommended action

Reinstall the toner cartridge.

Turn the product off and then on.

If the message persists, replace the toner cartridge.

49 Error Turn off then on

Description

The product experienced an internal error.

Recommended action

Turn the product off, wait at least 30 seconds, and then turn the product on and wait for it to initialize.

If you are using a surge protector, remove it. Plug the product directly into the wall socket. Turn the product power on.

If the message persists, contact HP support.

50.x Fuser Error Turn off then on

Description

The product has experienced an error with the fuser.

Recommended action

Turn the product power off, wait at least 30 seconds, and then turn the product power on and wait for it to initialize.

Turn off the product, wait at least 25 minutes, and then turn on the product.

If you are using a surge protector, remove it. Plug the product directly into the wall socket. Turn the product power on.

If the message persists, contact HP support.

51.XX Error Turn off then on

Description

The product has experienced an internal hardware error.

Recommended action

Turn the product power off, wait at least 30 seconds, and then turn the product power on and wait for it to initialize.

If you are using a surge protector, remove it. Plug the product directly into the wall socket. Turn the product on.

If the message persists, contact HP support.

54.XX Error Turn off then on

Description

The product has experienced an error with one of the internal sensors.

Recommended action

Turn the product power off, wait at least 30 seconds, and then turn the product power on and wait for it to initialize.

If you are using a surge protector, remove it. Plug the product directly into the wall socket. Turn the product power on.

If the message persists, contact HP support.

55.X Error Turn off then on

Description

The product has experienced an internal error.

Recommended action

Turn the product power off, wait at least 30 seconds, and then turn the product power on and wait for it to initialize.

If you are using a surge protector, remove it. Plug the product directly into the wall socket. Turn the product power on.

If the message persists, contact HP support.

57 Fan error Turn off then on

Description

The product has experienced a problem with its internal fan.

Recommended action

Turn the product power off, wait at least 30 seconds, and then turn the product power on and wait for it to initialize.

If you are using a surge protector, remove it. Plug the product directly into the wall socket. Turn the product power on.

If the message persists, contact HP support.

59.X Error Turn off then on

Description

The product has experienced a problem with one of the motors.

Recommended action

Turn the product power off, wait at least 30 seconds, and then turn the product power on and wait for it to initialize.

If you are using a surge protector, remove it. Plug the product directly into the wall socket. Turn the product power on.

If the message persists, contact HP support.

79 Error Turn off then on

Description

The product has experienced an internal firmware error.

Recommended action

Turn the product power off, wait at least 30 seconds, and then turn the product power on and wait for it to initialize.

If you are using a surge protector, remove it. Plug the product directly into the wall socket. Turn the product power on.

If the message persists, contact HP support.

79 Service error Turn off then on

Description

An incompatible DIMM is installed.

Recommended action

1. Turn the product power off.
2. Install a DIMM that the product supports.
3. Turn the product on.

If the message persists, contact HP support.

Black cartridge low

Description

The toner cartridge is nearing the end of its useful life.

Recommended action

Printing can continue, but consider having a replacement toner cartridge available.

Black cartridge very low

Description

The toner cartridge is at the end of its useful life. A customer configurable option on this product is "Prompt to Remind Me in 100 pages, 200 pages, 300 pages, 400 pages, or never." This option is provided as a customer convenience and is not an indication these pages will have acceptable print quality.

Recommended action

To ensure optimal print quality, HP recommends replacing the toner cartridge at this point. You can continue printing until you notice a decrease in print quality. Actual cartridge life may vary.

Once an HP toner cartridge has reached very low, HP's Premium Protection Warranty on that toner cartridge has ended. All print defects or cartridge failures incurred when an HP toner cartridge is used in continue at very low mode will not be considered to be defects in materials or workmanship in the toner cartridge under the HP Print Cartridge Warranty Statement.

Cleaning

Description

The product periodically performs a cleaning procedure to maintain the best print quality.

Recommended action

Wait for the cleaning process to finish.

Device error Press [OK]**Description**

An internal error occurred.

Recommended action

Press the **OK** button to resume the job.

Door open**Description**

The product front door is open.

Recommended action

Close the door.

Genuine HP supply installed**Description**

A genuine HP supply was installed.

Recommended action

No action necessary.

Install black cartridge**Description**

The toner cartridge is either not installed or not correctly installed in the product.

Recommended action

Install the toner cartridge.

Invalid driver Press [OK]**Description**

You are using an incorrect print driver.

Recommended action

Select the correct print driver.

Jam in <location>

Description

The product has detected a jam.

Recommended action

Clear the jam from the location indicated. The job should continue to print. If it does not, try reprinting the job.

If the message persists, contact HP support.

Jam in Tray <X> Clear jam and then Press [OK]

Description

The product has detected a jam.

Recommended action

Clear the jam from the location indicated, and then press **OK**.

If the message persists, contact HP support.

Load tray 1 <TYPE>, <SIZE>

Description

No trays are configured for the paper type and size that the print job is requesting.

Recommended action

Load the correct paper into Tray 1, or press **OK** to use paper in a different tray.

Load tray 1 PLAIN <SIZE> Cleaning Mode

Description

The product is ready to process the cleaning operation.

Recommended action

Load Tray 1 with plain paper in the size indicated, and then press the **OK** button.

Load tray <X> Press [OK] for available media

Description

The tray is empty.

Recommended action

Load paper into the tray to continue printing. Press the **OK** button to select a different tray.

Load tray <X> <TYPE> <SIZE>

Description

A tray is configured for the paper type and size that the print job is requesting, but that tray is empty.

Recommended action

Load the correct paper into the tray, or press the **OK** button to use paper in a different tray.

Manual duplex Load tray <X> Press [OK]

Description

The first side of a manual duplex job has printed, and the page needs to be loaded to process the second side.

Recommended action

Load the page in the indicated tray with the side to be printed face up, and the top of the page away from you, and then press the **OK** button.

Manual feed <SIZE>, <TYPE> Press [OK] for available media

Description

The product is set for manual feed mode.

Recommended action

Press the **OK** button to clear the message or load the correct paper into Tray 1.

Memory is low Press [OK]

Description

The product memory is almost full.

Recommended action

Press the **OK** button to finish the job, or press the Cancel **X** button to cancel the job.

Break the job into smaller jobs that contain fewer pages.

Misprint Press [OK]

Description

Paper has been delayed as it moves through the product.

Recommended action

Press the **OK** button to clear the message.

To avoid this problem, try the following solutions:

- Adjust the paper guides in the tray. Make sure the front paper guide is pushing the paper against the back edge of the tray.
- Use paper that meets HP specifications. Store paper unopened in its original packaging.
- Use the product in an area that meets the environmental specifications for this product.

Print failure, press OK. If error repeats, turn off then on.

Description

The product cannot process the page.

Recommended action

Press the **OK** button to continue printing the job, but output might be affected.

If the error persists, turn the power off and then on. Resend the print job.

Rear door open

Description

The product rear door is open.

Recommended action

Close the door.

Remove shipping material from toner cartridge

Description

A toner cartridge shipping lock is installed.

Recommended action

Pull the orange tab to remove the shipping lock from the cartridge.

Replace black cartridge

Description

The toner cartridge is at the end of its useful life, and the product is customer-configured to stop printing when it reaches the very low state.

Recommended action

To ensure optimal print quality, HP recommends replacing the toner cartridge at this point. You can continue printing until you notice a decrease in print quality. Actual cartridge life may vary. Once an HP toner cartridge has reached very low, HP's Premium Protection Warranty on that toner cartridge has ended. All print defects or cartridge failures incurred when an HP toner cartridge is used in continue at

very low mode will not be considered to be defects in materials or workmanship in the toner cartridge under the HP Print Cartridge Warranty Statement.

Supplies low

Description

A toner cartridge is low.

Recommended action

Printing will continue until a Very Low message displays. Consider having a replacement toner cartridge available.

Unexpected size in tray <X> Load <size> Press [OK]

Description

The product has detected paper in the tray that does not match the configuration for the tray.

Recommended action

Load the correct paper into the tray, or configure the tray for the size that you have loaded.

Unsupported black cartridge Press [OK] to continue

Description

The product has detected an installed toner cartridge that was not made by HP.

Recommended action

Press the **OK** button to continue printing.

If you believe you purchased an HP supply, go to www.hp.com/go/anticounterfeit. Service or repairs that are required as a result of using unsupported supplies are not covered under HP warranty.

Used black cartridge is installed Press [OK] to continue

Description

You are using a toner cartridge that reached the default low threshold while it was installed in another product.

Recommended action

Press the **OK** button to clear the message. Printing can continue, but consider having a replacement toner cartridge available.

Paper feeds incorrectly or becomes jammed

The product does not pick up paper

If the product does not pick up paper from the tray, try these solutions.

1. Open the product and remove any jammed sheets of paper.
2. Load the tray with the correct size of paper for your job.
3. Make sure the paper guides in the tray are adjusted correctly for the size of paper. Adjust the guides so they are touching the paper stack without bending it.
4. Check the product control panel to see if the product is waiting for you to acknowledge a prompt to feed the paper manually. Load paper, and continue.

The product picks up multiple sheets of paper

If the product picks up multiple sheets of paper from the tray, try these solutions.

1. Remove the stack of paper from the tray and flex it, rotate it 180 degrees, and flip it over. *Do not fan the paper.* Return the stack of paper to the tray.
2. Use only paper that meets HP specifications for this product.
3. Use paper that is not wrinkled, folded, or damaged. If necessary, use paper from a different package.
4. Make sure the tray is not overfilled. If it is, remove the entire stack of paper from the tray, straighten the stack, and then return some of the paper to the tray.
5. Make sure the paper guides in the tray are adjusted correctly for the size of paper. Adjust the guides so they are touching the paper stack without bending it.

Prevent paper jams

To reduce the number of paper jams, try these solutions.

1. Use only paper that meets HP specifications for this product.
2. Use paper that is not wrinkled, folded, or damaged. If necessary, use paper from a different package.
3. Use paper that has not previously been printed or copied on.
4. Make sure the tray is not overfilled. If it is, remove the entire stack of paper from the tray, straighten the stack, and then return some of the paper to the tray.
5. Make sure the paper guides in the tray are adjusted correctly for the size of paper. Adjust the guides so they are touching the paper stack without bending it.
6. If you are printing on heavy, embossed, or perforated paper, use the manual feed feature and feed sheets one at a time.

Clear jams

Jam locations

Jams can occur in these locations:

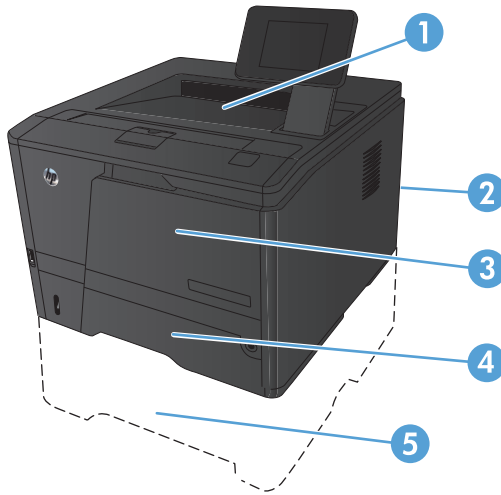

1	Output bin
2	Rear door
3	Tray 1
4	Tray 2
5	Optional Tray 3

Loose toner might remain in the product after a jam. This problem typically resolves itself after a few sheets have been printed.

Clear a jam in Tray 1



NOTE: If the sheet tears, remove all fragments before resuming printing.

1. If you can see the jammed sheet, remove the jammed sheet by pulling it straight out.

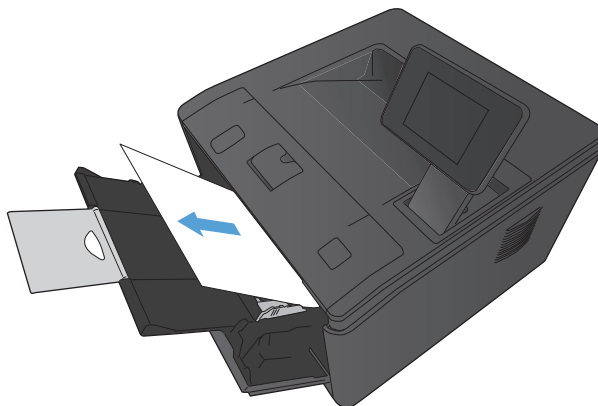

2. If you cannot see the jammed sheet, open the print cartridge door, and then remove the print cartridge.

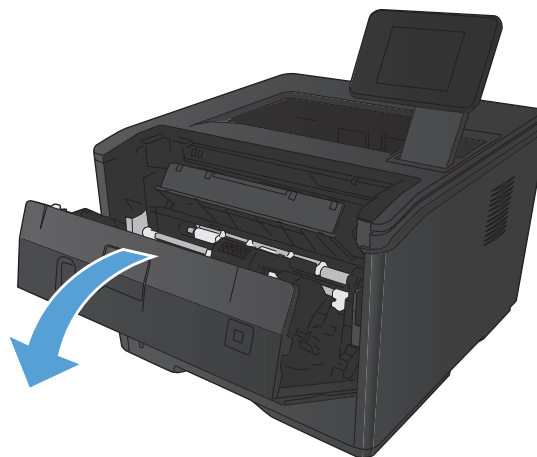

3. Remove the jammed sheet by pulling it straight out.

CAUTION: Do not pull up on the jammed sheet. Be sure to pull it straight out.

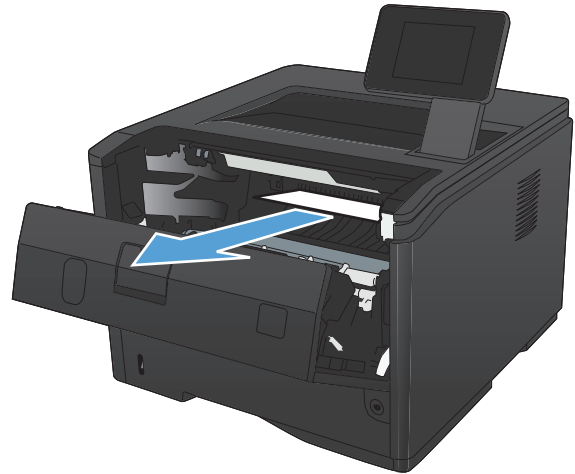

4. Reinstall the print cartridge, and then close the print cartridge door.

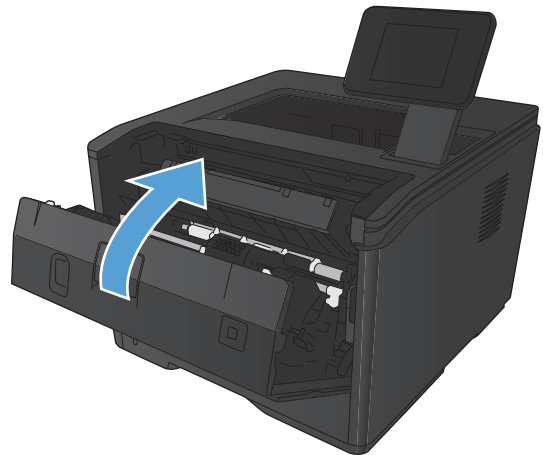

Clear a jam in Tray 2

1. Remove the tray from the product.

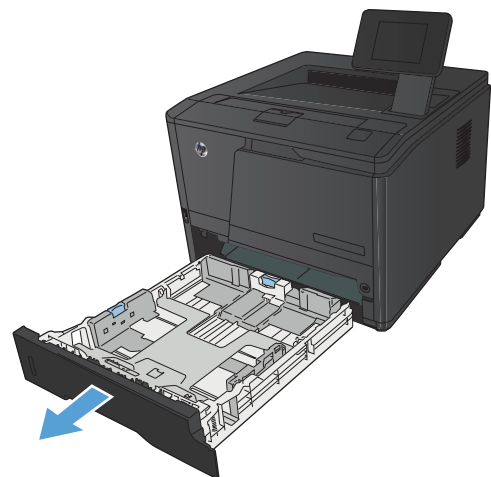

2. Remove the jammed sheet by pulling it straight out.

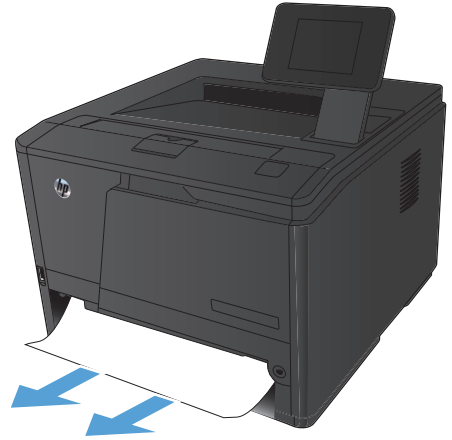

3. Replace the tray.

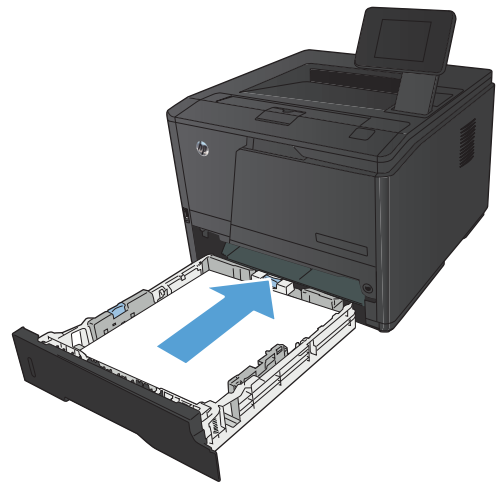

4. Press the **OK** button to continue printing.

Clear a jam in optional Tray 3

1. Remove the tray from the product.

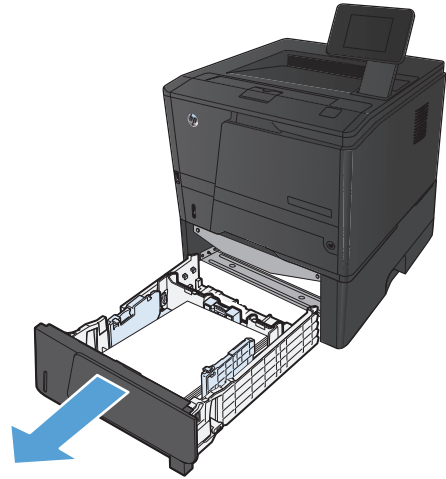

2. Remove the jammed sheet by pulling it straight out.

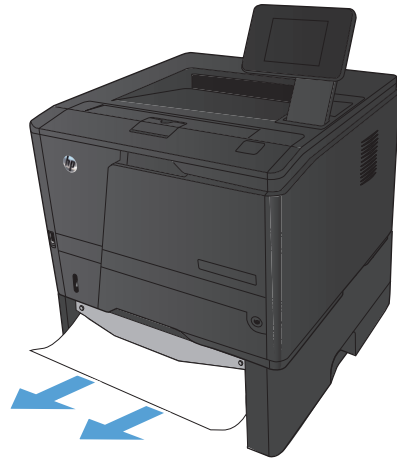

3. Replace the tray.

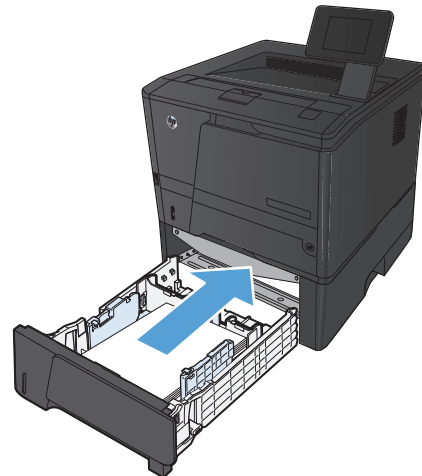

4. Press the **OK** button to continue printing.

Clear jams from the output bin

⚠ CAUTION: Do not use sharp objects, such as tweezers or needle-nose pliers, to remove jams. Damage caused by sharp objects will not be covered by the warranty.

1. With both hands, grasp the paper, and carefully pull it free from the product.



Clear a jam in the duplexer area

1. Open the rear door.

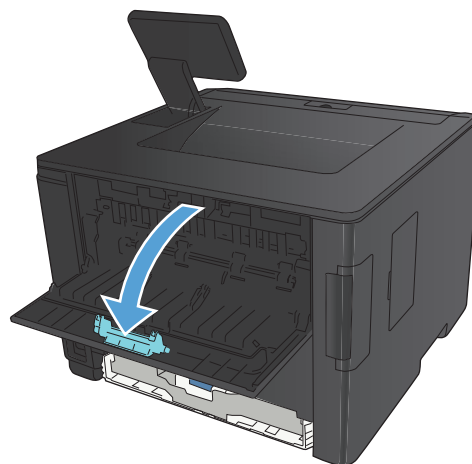

2. Remove any jammed sheets.

NOTE: If the sheet tears, remove all fragments before resuming printing.

CAUTION: Wait until the fuser area has cooled before clearing the jam.

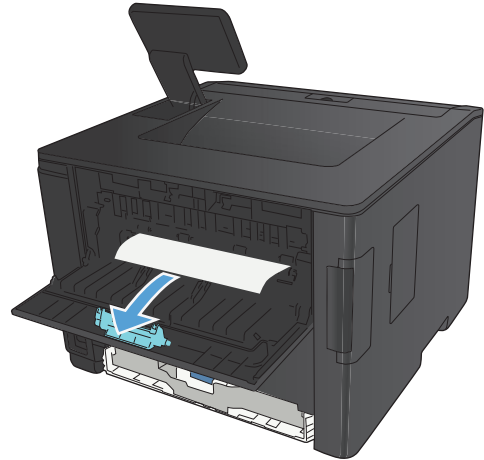

3. Close the rear door.

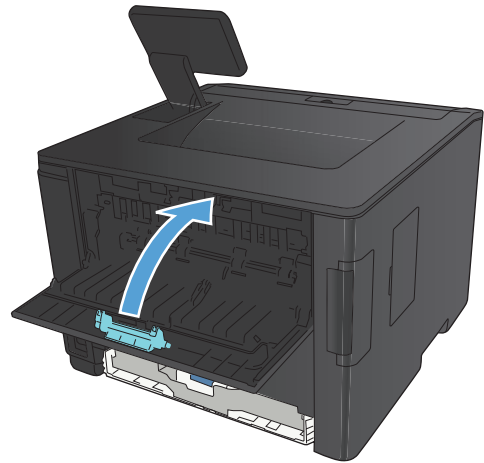

Clear a jam in the fuser area

1. Open the rear door.

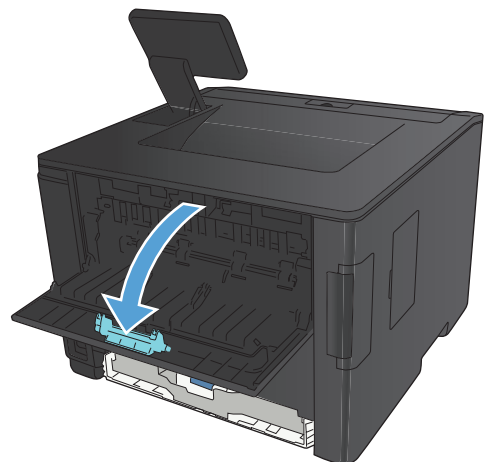

2. Remove any jammed sheets.

NOTE: If the sheet tears, remove all fragments before resuming printing.

CAUTION: Wait until the fuser area has cooled before clearing the jam.

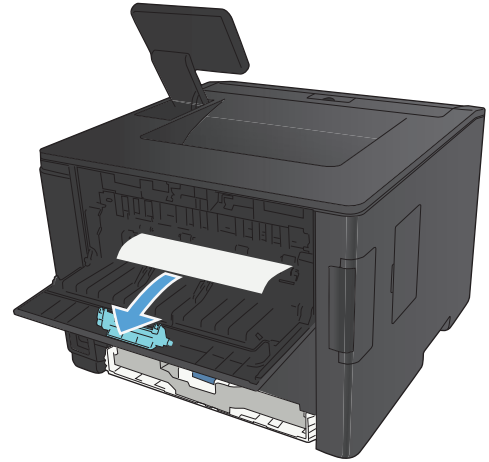

3. Close the rear door.

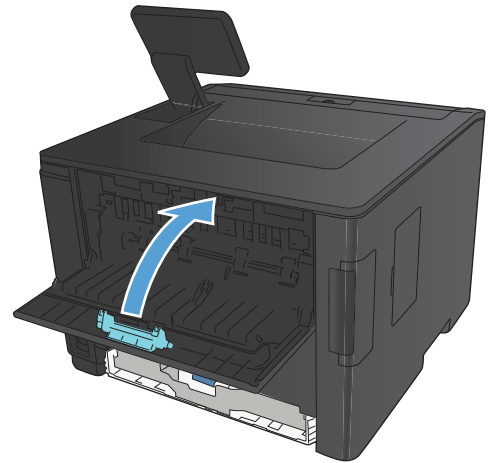

Improve print quality

Check the paper type setting (Windows)

Check the paper type setting if you are having any of the following problems:

- Toner is smearing on the printed pages.
 - Repeated marks occur on the printed pages.
 - Printed pages are curled.
 - Toner flakes off the printed pages.
 - Printed pages have small unprinted areas.
1. From the software program, select the **Print** option.
 2. Select the product, and then click the **Properties** or **Preferences** button.
 3. Click the **Paper/Quality** tab.
 4. From the **Paper type** drop-down list, click the **More...** option.
 5. Expand the list of **Type is:** options.
 6. Expand each category of paper types until you find the paper type that you are using.
 7. Select the option for the type of paper you are using, and then click the **OK** button.

Check the paper type setting (Mac OS X)

Check the paper type setting if you are having any of the following problems:

- Toner is smearing on the printed pages.
 - Repeated marks occur on the printed pages.
 - Printed pages are curled.
 - Toner flakes off the printed pages.
 - Printed pages have small unprinted areas.
1. On the **File** menu, click the **Print** option.
 2. In the **Printer** menu, select this product.
 3. In the **Copies & Pages** menu, click the **Page Setup** button.
 4. Select a size from the **Paper Size** drop-down list, and then click the **OK** button.
 5. Open the **Finishing** menu.

6. Select a type from the **Media-type** drop-down list.
7. Click the **Print** button.

Check toner cartridge status

Print the supplies status page (LCD control panel)

Information pages reside within the product memory. These pages help diagnose and solve problems with the product.

 **NOTE:** If the product language was not correctly set during installation, you can set the language manually so the information pages print in one of the supported languages. Change the language by using the **System Setup** menu on the control panel or the embedded Web server.

1. On the product control panel, press the **OK** button to open the menus.
2. Open the **Reports** menu.
3. Select the **Supplies Status** item, and then press the **OK** button to print the report.
4. Check the Supplies Status Page for "Approximate Pages Remaining" and other information regarding the toner cartridge.

Print the supplies status page (touchscreen control panel)

Information pages reside within the product memory. These pages help diagnose and solve problems with the product.

 **NOTE:** If the product language was not correctly set during installation, you can set the language manually so the information pages print in one of the supported languages. Change the language by using the **System Setup** menu on the control panel or the embedded Web server.

1. From the Home screen on the product control panel, touch the Setup  button.
2. Touch the **Reports** button.
3. Touch the **Supplies Status** button to print the report.

Check the supplies status

Check the supplies status page for the following information:

- Estimated percentage of cartridge life remaining
- Approximate pages remaining
- Part numbers for HP toner cartridges
- Number of pages printed

Print a cleaning page

Print a cleaning page to remove dust and excess toner from the paper path if you are having any of the following problems:

- Specks of toner are on the printed pages.
- Toner is smearing on the printed pages.
- Repeated marks occur on the printed pages.

Print a cleaning page (LCD control panel)

1. On the product control panel, press the **OK** button to open the menus.
2. Open the following menus:
 - **Service**
 - **Cleaning Page**
3. Load plain paper in Tray 1, and then press the **OK** button to start the cleaning process.
Wait until the process is complete. Discard the page that prints.

Print a cleaning page (touchscreen control panel)

1. From the Home screen on the product control panel, touch the Setup  button.
2. Touch the **Service** menu.
3. Touch the **Cleaning Page** button.
4. Load plain letter or A4 paper when you are prompted.
5. Touch the **OK** button to begin the cleaning process.
Wait until the process is complete. Discard the page that prints.

Inspect the toner cartridge for damage

1. Remove the toner cartridge from the product, and verify that the sealing tape has been removed.

2. Check the memory chip for damage.

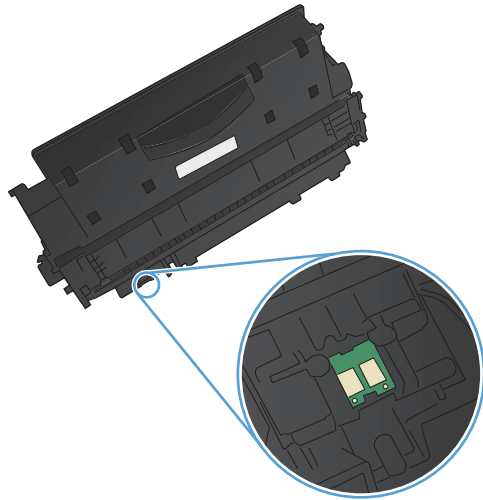

3. Examine the surface of the imaging drum on the bottom of the toner cartridge.

⚠ CAUTION: Do not touch the roller (imaging drum) on the bottom of the cartridge. Fingerprints on the imaging drum can cause print-quality problems.

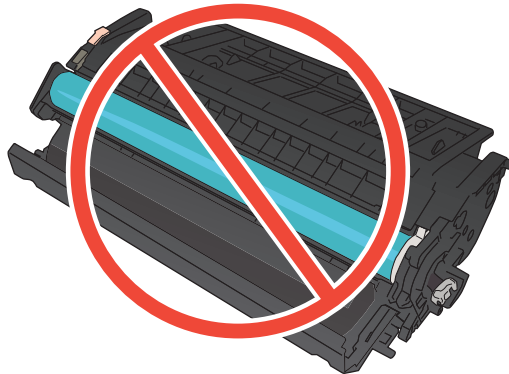

4. If you see any scratches, fingerprints, or other damage on the imaging drum, replace the toner cartridge.
5. If the imaging drum does not appear to be damaged, rock the toner cartridge gently several times and reinstall it. Print a few pages to see if the problem has resolved.

Check the paper and printing environment

Use paper that meets HP specifications

Use different paper if you are having any of the following problems:

- The printing is too light or seems faded in areas.
- Specks of toner are on the printed pages.
- Toner is smearing on the printed pages.
- Printed characters seem misformed.
- Printed pages are curled.

Always use a paper type and weight that this product supports. In addition, follow these guidelines when selecting paper:

- Use paper that is of good quality and free of cuts, nicks, tears, spots, loose particles, dust, wrinkles, voids, staples, and curled or bent edges.
- Use paper that has not been previously printed on.
- Use paper that is designed for use in laser printers. Do not use paper that is designed only for use in inkjet printers.
- Use paper that is not too rough. Using smoother paper generally results in better print quality.

Check the product environment

Verify that the product is operating within the environmental specifications listed in the product Warranty and Legal Guide.

Check print job settings

Check the EconoMode setting

This product has an EconoMode option for printing drafts of documents. Using EconoMode can use less toner. However, using EconoMode can also reduce print quality. To improve print quality, verify that the EconoMode setting is deactivated.

1. From the software program, select the **Print** option.
2. Select the product, and then click the **Properties** or **Preferences** button.
3. Click the **Paper/Quality** tab.
4. Verify that the **EconoMode** check box is cleared. If there is a checkmark in the check box, click the check box to clear it.

HP does not recommend the full-time use of EconoMode. If EconoMode is used full-time, the toner supply might outlast the mechanical parts in the toner cartridge. If print quality begins to degrade and is no longer acceptable, consider replacing the toner cartridge.

Use the print driver that best meets your printing needs

You might need to use a different print driver if the printed page has unexpected lines in graphics, missing text, missing graphics, incorrect formatting, or substituted fonts.

HP PCL 6 driver	<ul style="list-style-type: none">• Provided as the default driver. This driver is automatically installed by the HP installer.• Recommended for all Windows environments• Provides the overall best speed, print quality, and product-feature support for most users• Developed to align with the Windows Graphic Device Interface (GDI) for the best speed in Windows environments• Might not be fully compatible with third-party and custom software programs that are based on PCL 5
HP UPD PS driver	<ul style="list-style-type: none">• Recommended for printing with Adobe® software programs or with other highly graphics-intensive software programs• Provides support for printing from postscript emulation needs, or for postscript flash font support• Available for download from www.hp.com/go/upd
HP UPD PCL 5 driver	<ul style="list-style-type: none">• Recommended for general office printing in Windows environments• Compatible with previous PCL versions and older HP LaserJet products• The best choice for printing from third-party or custom software programs• The best choice when operating with mixed environments that require the product to be set to PCL 5 (UNIX, Linux, mainframe)• Designed for use in corporate Windows environments to provide a single driver for use with multiple printer models• Preferred when printing to multiple printer models from a mobile Windows computer• Available for download from www.hp.com/go/upd
HP UPD PCL 6 driver	<ul style="list-style-type: none">• Recommended for printing in all Windows environments• Provides the overall best speed, print quality, and printer feature support for most users• Developed to align with Windows Graphic Device Interface (GDI) for best speed in Windows environments• May not be fully compatible with third-party and custom solutions based on PCL5• Available for download from www.hp.com/go/upd

Download additional print drivers from this Web site: www.hp.com/support/ljm401series.

The product does not print or it prints slowly

The product does not print

If the product does not print at all, try the following solutions.

1. Make sure the product is turned on and that the control panel indicates it is ready.
 - If the control panel does not indicate the product is ready, turn the product off and then on again.
 - If the control panel indicates the product is ready, try sending the job again.
2. If the control panel indicates the product has an error, resolve the error and then try sending the job again.
3. Make sure the cables are all connected correctly. If the product is connected to a network, check the following items:
 - Check the light next to the network connection on the product. If the network is active, the light is green.
 - Make sure that you are using a network cable and not a phone cord to connect to the network.
 - Make sure the network router, hub, or switch is turned on and that it is working correctly.
4. Install the HP software from the CD that came with the product, or download the latest print driver from www.hp.com or the **HP Smart Install** tab of the HP Embedded Web Server. Using generic print drivers can cause delays clearing jobs from the print queue.
5. From the list of printers on your computer, right-click the name of this product, click **Properties**, and open the **Ports** tab.
 - If you are using a network cable to connect to the network, make sure the printer name listed on the **Ports** tab matches the product name on the product configuration page.
 - If you are using a USB cable and are connecting to a wireless network, make sure the box is checked next to **Virtual printer port for USB**.
6. If you are using a personal firewall system on the computer, it might be blocking communication with the product. Try temporarily disabling the firewall to see if it is the source of the problem.
7. If your computer or the product is connected to a wireless network, low signal quality or interference might be delaying print jobs.

The product prints slowly

If the product prints, but it seems slow, try the following solutions.

1. Make sure the computer meets the minimum specifications for this product. For a list of specifications, go to this Web site: www.hp.com/support/ljm401series.
2. When you configure the product to print on some paper types, such as heavy paper, the product prints more slowly so it can correctly fuse the toner to the paper. If the paper type setting is not correct for the type of paper you are using, change the setting to the correct paper type. Using the archive printing mode also will slow the product printing process.
3. If your computer or the product is connected to a wireless network, low signal quality or interference might be delaying print jobs.

Solve walk-up USB printing problems



NOTE: This section applies only to the HP LaserJet Pro 400 M401dn Printer and HP LaserJet Pro 400 M401dw Printer models.

- [The USB Flash Drive menu does not open when you insert the USB accessory](#)
- [The file does not print from the USB storage accessory](#)
- [The file that you want to print is not listed in the USB Flash Drive menu](#)

The USB Flash Drive menu does not open when you insert the USB accessory

1. You might be using a USB storage accessory or a file system that this product does not support. Save the files on a standard USB storage accessory that uses File Allocation Table (FAT) file systems. The product supports FAT12, FAT16, and FAT32 USB storage accessories.
2. If another menu is already open, close that menu and then reinsert the USB storage accessory.
3. The USB storage accessory might have multiple partitions. (Some USB storage accessory manufacturers install software on the accessory that creates partitions, similar to a CD.) Reformat the USB storage accessory to remove the partitions, or use a different USB storage accessory.
4. The USB storage accessory might require more power than the product can provide.
 - a. Remove the USB storage accessory.
 - b. Turn the product off and then on.
 - c. Use a USB storage accessory that has its own power supply or that requires less power.
5. The USB storage accessory might not be functioning correctly.
 - a. Remove the USB storage accessory.
 - b. Turn the product off and then on.
 - c. Try printing from another USB storage accessory.

The file does not print from the USB storage accessory

1. Make sure paper is in the tray.
2. Check the control panel for messages. If paper is jammed in the product, clear the jam.

The file that you want to print is not listed in the USB Flash Drive menu

1. You might be trying to print a file type that the USB printing feature does not support. The product supports .PDF and .JPEG file types.
2. You might have too many files in a single folder on the USB storage accessory. Reduce the number of files in the folder by moving them to subfolders.
3. You might be using a character set for the file name that the product does not support. In this case, the product replaces the file names with characters from a different character set. Rename the files using ASCII characters.

Solve direct connection problems

If you have connected the product directly to a computer, check the cable.

- Verify that the cable is connected to the computer and to the product.
- Verify that the cable is not longer than 5 m (16.4 ft). Try using a shorter cable.
- Verify that the cable is working correctly by connecting it to another product. Replace the cable if necessary.

Solve wired network problems

 **NOTE:** This section applies to all models except the HP LaserJet Pro 400 M401a Printer and HP LaserJet Pro 400 M401d Printer models.

Check the following items to verify that the product is communicating with the network. Before beginning, print a configuration page from the product control panel and locate the product IP address that is listed on this page.

- [Poor physical connection](#)
- [The computer is using the incorrect IP address for the product](#)
- [The computer is unable to communicate with the product](#)
- [The product is using incorrect link and duplex settings for the network](#)
- [New software programs might be causing compatibility problems](#)
- [The computer or workstation might be set up incorrectly](#)
- [The product is disabled, or other network settings are incorrect](#)

 **NOTE:** HP does not support peer-to-peer networking, as the feature is a function of Microsoft operating systems and not of the HP print drivers. For more information, go to Microsoft at www.microsoft.com.

Poor physical connection

1. Verify that the product is attached to the correct network port using a cable of the correct length.
2. Verify that cable connections are secure.
3. Look at the network port connection on the back of the product, and verify that the amber activity light and the green link-status light are lit.
4. If the problem continues, try a different cable or port on the hub.

The computer is using the incorrect IP address for the product

1. Open the printer properties and click the **Ports** tab. Verify that the current IP address for the product is selected. The product IP address is listed on the product configuration page.
2. If you installed the product using the HP standard TCP/IP port, select the box labeled **Always print to this printer, even if its IP address changes**.
3. If you installed the product using a Microsoft standard TCP/IP port, use the hostname instead of the IP address.
4. If the IP address is correct, delete the product and then add it again.
5. Create a new HP TCP/IP port with the correct address.

The computer is unable to communicate with the product

1. Test network communication by pinging the network.
 - a. Open a command-line prompt on your computer. For Windows, click **Start**, click **Run**, and then type `cmd`.
 - b. Type `ping` followed by the IP address for your product.

For Mac OS X, open the Network Utility, and then supply the IP address in the correct field in the **Ping** pane.
 - c. If the window displays round-trip times, the network is working.
2. If the ping command failed, verify that the network hubs are on, and then verify that the network settings, the product, and the computer are all configured for the same network.



NOTE: You also can test the network connection by attempting to open the HP Embedded Web Server in a supported Web browser.

The product is using incorrect link and duplex settings for the network

Hewlett-Packard recommends leaving this setting in automatic mode (the default setting). If you change these settings, you must also change them for your network.

New software programs might be causing compatibility problems

Verify that any new software programs are correctly installed and that they use the correct print driver.

The computer or workstation might be set up incorrectly

1. Check the network drivers, print drivers, and the network redirection.
2. Verify that the operating system is configured correctly.

The product is disabled, or other network settings are incorrect

1. Review the configuration page to check the status of the network protocol. Enable it if necessary.
2. Reconfigure the network settings if necessary.

Solve wireless network problems

 **NOTE:** This section applies to the HP LaserJet Pro 400 M401dw Printer model only.

Wireless connectivity checklist

- Verify that the network cable is not connected.
- Verify that the product and the wireless router are turned on and have power. Also make sure that the wireless radio in the product is turned on.
- Verify that the service set identifier (SSID) is correct. Print a configuration page to determine the SSID. If you are not sure the SSID is correct, run the wireless setup again.
- With secured networks, verify that the security information is correct. If the security information is incorrect, run the wireless setup again.
- If the wireless network is working correctly, try accessing other computers on the wireless network. If the network has Internet access, try connecting to the Internet over a wireless connection.
- Verify that the encryption method (AES or TKIP) is the same for the product as it is for the wireless access point (on networks using WPA security).
- Verify that the product is within the range of the wireless network. For most networks, the product must be within 30 m (100 ft) of the wireless access point (wireless router).
- Verify that obstacles do not block the wireless signal. Remove any large metal objects between the access point and the product. Make sure poles, walls, or support columns containing metal or concrete do not separate the product and wireless access point.
- Verify that the product is located away from electronic devices that might interfere with the wireless signal. Many devices can interfere with the wireless signal including motors, cordless phones, security system cameras, other wireless networks, and some Bluetooth devices.
- Verify that the print driver is installed on the computer.
- Verify that you have selected the correct printer port.
- Verify that the computer and product connect to the same wireless network.
- For Mac OS X, verify that the wireless router supports Bonjour.

The product does not print after the wireless configuration completes

1. Make sure that the product is turned on and in the ready state.
2. Turn off any third-party firewalls on your computer.
3. Make sure that the wireless network is working correctly.

4. Make sure that your computer is working correctly. If necessary, restart the computer.
5. Try manually configuring the product from the control panel.

The product does not print, and the computer has a third-party firewall installed

1. Update the firewall with the most recent update available from the manufacturer.
2. If programs request firewall access when you install the product or try to print, make sure you allow the programs to run.
3. Temporarily turn off the firewall, and then install the wireless product on the computer. Enable the firewall when you have completed the wireless installation.

The wireless connection does not work after moving the wireless router or product

1. Make sure that the router or product connects to the same network that your computer connects to.
2. Print a configuration page.
3. Compare the service set identifier (SSID) on the configuration page to the SSID in the printer configuration for the computer.
4. If the numbers are not the same, the devices are not connecting to the same network. Reconfigure the wireless setup for the product.

Cannot connect more computers to the wireless product

1. Make sure that the other computers are within the wireless range and that no obstacles block the signal. For most networks, the wireless range is within 30 m (100 ft) of the wireless access point.
2. Make sure that the product is turned on and in the ready state.
3. Turn off any third-party firewalls on your computer.
4. Make sure that the wireless network is working correctly.
5. Make sure that your computer is working correctly. If necessary, restart the computer.

The wireless product loses communication when connected to a VPN

- Typically, you cannot connect to a VPN and other networks at the same time.

The network does not appear in the wireless networks list

- Make sure the wireless router is turned on and has power.
- The network might be hidden. However, you can still connect to a hidden network.

The wireless network is not functioning

1. Make sure that the network cable is not connected.
2. To verify if the network has lost communication, try connecting other devices to the network.
3. Test network communication by pinging the network.
 - a. Open a command-line prompt on your computer. For Windows, click **Start**, click **Run**, and then type `cmd`.
 - b. Type `ping` followed by the router IP address.

For Mac OS X, open the Network Utility, and then supply the IP address in the correct field in the **Ping** pane.
 - c. If the window displays round-trip times, the network is working.
4. Make sure that the router or product connects to the same network that the computer connects to.
 - a. Print a configuration page.
 - b. Compare the service set identifier (SSID) on the configuration report to the SSID in the printer configuration for the computer.
 - c. If the numbers are not the same, the devices are not connecting to the same network. Reconfigure the wireless setup for the product.

Perform a wireless network diagnostic test

From the product control panel, you can run a diagnostic test that provides information about the wireless network settings.

1. From the Home screen on the product control panel, touch the Setup  button.
2. Open the following menus
 - **System Setup**
 - **Self Diagnostics**
3. Touch the **Run Network Test** button to start the test. The product prints a test page that shows test results.

Reduce interference on a wireless network

The following tips can reduce interference in a wireless network:

- Keep the wireless devices away from large metal objects, such as filing cabinets, and other electromagnetic devices, such as microwaves and cordless telephones. These objects can disrupt radio signals.
- Keep the wireless devices away from large masonry structures and other building structures. These objects can absorb radio waves and lower signal strength.
- Position the wireless router in a central location in line of sight with the wireless products on the network.

Solve product software problems with Windows

A print driver for the product is not visible in the Printer folder

1. Reinstall the product software.

 **NOTE:** Close any applications that are running. To close an application that has an icon in the system tray, right-click the icon, and select **Close** or **Disable**.

2. Try plugging the USB cable into a different USB port on the computer.

An error message was displayed during the software installation

1. Reinstall the product software.

 **NOTE:** Close any applications that are running. To close an application that has an icon in the system tray, right-click the icon, and select **Close** or **Disable**.

2. Check the amount of free space on the drive where you are installing the product software. If necessary, free up as much space as you can, and reinstall the product software.
3. If necessary, run the Disk Defragmenter, and reinstall the product software.

The product is in Ready mode, but nothing prints

1. Print a configuration page, and verify the product functionality.
2. Verify that all of the cables are correctly seated and within specifications. This includes the USB and power cables. Try a new cable.
3. Verify that the IP address on the configuration page matches the IP address for the software port. Use one of the following procedures:

Windows XP, Windows Server 2003, Windows Server 2008, and Windows Vista

- a. Click **Start**.
- b. Click **Settings**.
- c. Click **Printers and Faxes** (using the default Start menu view) or click **Printers** (using the Classic Start menu view).
- d. Right-click the product driver icon, and then select **Properties**.
- e. Click the **Ports** tab, and then click **Configure Port**.
- f. Verify the IP address, and then click **OK** or **Cancel**.
- g. If the IP addresses are not the same, delete the driver, and reinstall the driver using the correct IP address.
- h. Create a new HP TCP/IP port using the correct IP address.

Windows 7

- a. Click **Start**.
 - b. Click **Devices and Printers**.
 - c. Right-click the product driver icon, and then select **Printer properties**.
 - d. Click the **Ports** tab, and then click **Configure Port**.
 - e. Verify the IP address, and then click **OK** or **Cancel**.
 - f. If the IP addresses are not the same, delete the driver, and reinstall the driver using the correct IP address.
 - g. Create a new HP TCP/IP port using the correct IP address.
4. Try using the IP address to open the HP Embedded Web Server in a supported Web browser.

Solve product software problems with Mac OS X

- [The print driver is not listed in the Print & Fax or Print & Scan list](#)
- [The product name does not appear in the product list in the Print & Fax or Print & Scan list](#)
- [The print driver does not automatically set up the selected product in the Print & Fax or Print & Scan list](#)
- [A print job was not sent to the product that you wanted](#)
- [When connected with a USB cable, the product does not appear in the Print & Fax or Print & Scan list after the driver is selected.](#)
- [You are using a generic print driver when using a USB connection](#)

The print driver is not listed in the Print & Fax or Print & Scan list

1. Make sure that the product .GZ file is in the following hard-drive folder: Library/Printers/PPDs/Contents/Resources. If necessary, reinstall the software.
2. If the GZ file is in the folder, the PPD file might be corrupt. Delete the file and then reinstall the software.

The product name does not appear in the product list in the Print & Fax or Print & Scan list

1. Make sure that the cables are connected correctly and the product is on.
2. Use the + button to add the product to the **Print & Fax (Print & Scan** in Mac OS X v10.7) list.
3. Replace the USB or network cable with a high-quality cable.

The print driver does not automatically set up the selected product in the Print & Fax or Print & Scan list

1. Make sure that the cables are connected correctly and the product is on.
2. Make sure that the product .GZ file is in the following hard-drive folder: Library/Printers/PPDs/Contents/Resources. If necessary, reinstall the software.
3. If the GZ file is in the folder, the PPD file might be corrupt. Delete the file and then reinstall the software.
4. Use the + button to add the product to the **Print & Fax (Print & Scan** in Mac OS X v10.7) list.
5. Replace the USB or network cable with a high-quality cable.

A print job was not sent to the product that you wanted

1. Open the print queue and restart the print job.
2. Another product with the same or similar name might have received your print job. Print a configuration page to check the product name. Verify that the name on the configuration page matches the product name in the **Print & Fax** (**Print & Scan** in Mac OS X v10.7) list.

When connected with a USB cable, the product does not appear in the Print & Fax or Print & Scan list after the driver is selected.

Software troubleshooting

1. Make sure that your Mac operating system is Mac OS X 10.5 or later.
2. Use the + button to add the product to the **Print & Fax** (**Print & Scan** in Mac OS X v10.7) list.

Hardware troubleshooting

1. Make sure that the product is turned on.
2. Make sure that the USB cable is connected correctly.
3. Make sure that you are using the appropriate Hi-Speed USB cable.
4. Make sure that you do not have too many USB devices drawing power from the chain. Disconnect all of the devices from the chain, and then connect the cable directly to the USB port on the computer.
5. Check to see if more than two non-powered USB hubs are connected in a row on the chain. Disconnect all of the devices from the chain, and then connect the cable directly to the USB port on the computer.

 **NOTE:** The iMac keyboard is a non-powered USB hub.

You are using a generic print driver when using a USB connection

If you connected the USB cable before you installed the software, you might be using a generic print driver instead of the driver for this product.

1. Delete the generic print driver.
2. Reinstall the software from the product CD. Do not connect the USB cable until the software installation program prompts you.
3. If multiple printers are installed, make sure that you have selected the correct printer in the **Format For** drop-down menu in the **Print** dialog box.

Remove software (Windows)

Windows XP

1. Click **Start**, and then click **Programs**.
2. Click **HP**, and then click the product name.
3. Click **Uninstall**, and then follow the onscreen instructions to remove the software.

Windows Vista and Windows 7

1. Click **Start**, and then click **All Programs**.
2. Click **HP**, and then click the product name.
3. Click **Uninstall**, and then follow the onscreen instructions to remove the software.

Remove software (Mac OS X)

You must have administrator rights to remove the software.

1. Disconnect the product from the computer.
2. Open **Applications**.
3. Select **Hewlett Packard**.
4. Select **HP Uninstaller**.
5. Select the product from the list of devices, and then click the **Uninstall** button.
6. After the software is uninstalled, restart the computer and empty the Trash.

6 Supplies and accessories

- [Order parts, accessories, and supplies](#)
- [HP policy on non-HP supplies](#)
- [HP anticounterfeit Web site](#)

Order parts, accessories, and supplies

HP original toner cartridge and paper	www.hp.com/go/suresupply
Order genuine HP parts or accessories	www.hp.com/buy/parts
Order through service or support providers	Contact an HP-authorized service or support provider.

Item	Part number	Cartridge number	Description
HP LaserJet toner cartridge	CF280A (standard)	80A	Black toner cartridge
	CF280X (extended)	80X	
Input tray	CF284A		500-sheet Tray 3
USB 2.0 printer cable	C6518A		(2-meter standard) A-to-B cable

HP policy on non-HP supplies

Hewlett-Packard Company cannot recommend the use of non-HP toner cartridges, either new or remanufactured.

 **NOTE:** For HP printer products, the use of a non-HP toner cartridge or a refilled toner cartridge does not affect either the warranty to the customer or any HP support contract with the customer. However, if product failure or damage is attributable to the use of a non-HP toner cartridge or refilled toner cartridge, HP will charge its standard time and materials charges to service the product for the particular failure or damage.

HP anticounterfeit Web site

Go to www.hp.com/go/anticounterfeit when you install an HP toner cartridge and the control-panel message says the cartridge is non-HP. HP will help determine if the cartridge is genuine and take steps to resolve the problem.

Your toner cartridge might not be a genuine HP toner cartridge if you notice the following:

- The supplies status page indicates that a non-HP supply is installed.
- You are experiencing a high number of problems with the toner cartridge.
- The cartridge does not look like it usually does (for example, the packaging differs from HP packaging).

Index

A

- accessories
 - ordering 129, 130
- AirPrint 54
- amber light 4
- antcounterfeit supplies 130
- applications
 - downloading 60
- apps button 7
- Apps menu 60
- archival-quality printing
 - creating 51
 - LCD control panel 51
 - touchscreen control panel 51
- attention light
 - LCD control panel 4
 - touchscreen control panel 5
- automatic duplex printing (double-sided)
 - with Mac 43
 - with Windows 31

B

- back arrow
 - LCD control panel 4
- back button
 - touchscreen control panel 5
- bin, output
 - locating 2
- bins, output
 - jams, clearing 103
- booklets
 - printing (Mac) 46
 - printing (Windows) 41
- buttons
 - on LCD control panel 4
 - on touchscreen control panel 5
- buttons on control panel 4

C

- cancel button
 - LCD control panel 4
 - touchscreen control panel 5
- canceling
 - print job (Mac) 49
 - print job (Windows) 47
- cartridge
 - part numbers 130
 - replacing 77
 - supplies status page 8
- cartridges
 - non-HP 130
 - recycling 76
 - storage 76
- cleaning
 - paper path 108
- configuration page 8
- control panel
 - buttons and lights 4
 - help 87
 - locating 2
 - menu map, printing 8
 - message types 88
 - messages, troubleshooting 88
 - Reports menu 8, 9
- counterfeit supplies 130

D

- default gateway, setting 61
- defaults, restoring 86
- door release, locating 2
- drivers
 - changing settings (Mac) 26
 - changing settings (Windows) 24
 - presets (Mac) 43
 - settings (Mac) 43
 - usage page 8

- duplex printing (double-sided)
 - automatic settings (Mac) 43
 - automatic settings (Windows) 31
 - manual settings (Mac) 44
 - manual settings (Windows) 32
- duplex settings, changing 63

E

- EconoMode settings 71
 - checking 110
- economy settings 71
- Embedded Web Server
 - changing network settings 61
 - changing password 69
 - changing product name 62
 - opening 61, 62, 69
- envelopes
 - supported sizes 12
- error messages, control panel 88
- errors
 - software 123

F

- factory-set defaults, restoring 86
- fonts
 - lists, printing 8
- fraud Web site 130
- front cover
 - locating 2

G

- gateway, setting default 61
- green light 4

H

- help button and light
 - touchscreen control panel 5
- help, control panel 87

- home button 5
 - Home screen, control panel 7
 - HP Device Toolbox, using 65
 - HP Embedded Web Server
 - changing network settings 61
 - changing password 69
 - changing product name 62
 - opening 61, 62, 69
 - HP ePrint
 - setup 52, 53
 - using 52
 - HP fraud Web site 130
 - HP PCL 6 print driver 111
 - HP Reconfiguration Utility
 - network installation 58
 - HP UPD PCL 5 print driver 111
 - HP UPD PCL 6 print driver 111
 - HP UPD PS print driver 111
 - HP Utility for Mac
 - Bonjour 67
 - features 67
 - opening 67
 - HP Utility, Mac 67
 - HP Web Jetadmin 68
 - HP Web Services
 - applications 60
 - enabling 52, 60
- I**
- information button 7
 - input tray
 - loading 15
 - locating 2
 - input trays
 - loading 15
 - interface ports
 - locating 3
 - IPv4 address 61
- J**
- jams
 - locating 98
 - output bin, clearing 103
 - preventing 97
 - tracking number of 8
 - Jetadmin, HP Web 68
- L**
- landscape orientation
 - changing (Mac) 45
 - changing (Windows) 36
 - LCD control panel
 - buttons and lights 4
 - LED light 4
 - left arrow
 - LCD control panel 4
 - touchscreen control panel 5
 - lights
 - on LCD control panel 4
 - on touchscreen control panel 5
 - lights on control panel 4
 - link speed settings 63
 - loading paper
 - input tray 15
 - lock
 - product 69
- M**
- Mac
 - driver settings 26, 43
 - HP Utility 67
 - problems, troubleshooting 125
 - managing network 61
 - media
 - pages per sheet (Mac) 45
 - menus, control panel
 - map, printing 8
 - messages, control panel 88
 - model number
 - locating 3
 - multiple pages per sheet
 - Mac 45
 - printing (Windows) 34
- N**
- n-up printing
 - Mac 45
 - selecting (Windows) 34
 - network
 - password, changing 69
 - password, setting 69
 - product name, changing 62
 - settings, changing 61
 - settings, viewing 61
 - test wireless 121
 - network button 7
 - network port
 - locating 3
 - networks
 - configuration page 8
 - default gateway 61
 - installing the product 58
 - IPv4 address 61
 - settings report 8
 - subnet mask 61
 - non-HP supplies 130
- O**
- Ok button 4
 - online help, control panel 87
 - ordering
 - supplies and accessories 130
 - ordering supplies
 - Web sites 129
 - orientation
 - changing (Mac) 45
 - changing (Windows) 36
 - output bin
 - locating 2
- P**
- page count 8
 - page orientation
 - changing (Mac) 45
 - changing (Windows) 36
 - page sizes
 - scaling documents to fit (Mac) 46
 - scaling documents to fit (Windows) 40
 - pages per sheet
 - Mac 45
 - selecting (Windows) 34
 - paper
 - jams 97
 - ordering 130
 - pages per sheet (Mac) 45
 - selecting 110
 - supported sizes 12
 - supported types 14
 - paper environment 110
 - paper jams
 - locating 98
 - paper path
 - cleaning 108
 - paper pickup problems
 - solving 97
 - paper sizes
 - selecting (Mac) 49
 - selecting (Windows) 47

- selecting custom sizes (Mac) 49
 - selecting custom sizes (Windows) 47
 - paper type
 - checking settings 106
 - paper types
 - selecting (Mac) 45
 - selecting (Windows) 37
 - paper, covers
 - printing (Mac) 46
 - printing (Windows) 38
 - part numbers
 - toner cartridge 130
 - PCL font list 8
 - portrait orientation
 - changing (Mac) 45
 - changing (Windows) 36
 - ports
 - locating 3
 - power button
 - locating 2
 - power connection
 - locating 3
 - power-down delay
 - setting 72
 - presets (Mac) 43
 - print drivers
 - choosing 111
 - print drivers (Mac)
 - changing settings 26
 - settings 43
 - print job
 - canceling (Mac) 49
 - canceling (Windows) 47
 - print job settings
 - checking 110
 - print quality
 - improving 106
 - printer driver (Windows)
 - supported 22
 - printer drivers (Mac)
 - settings 43
 - printer drivers (Windows)
 - changing settings 24
 - printing
 - from USB storage accessories 55
 - product reports 8, 9
 - settings (Mac) 43
 - printing environment 110
 - printing on both sides
 - automatic settings (Mac) 43
 - automatic settings (Windows) 31
 - manual settings (Mac) 44
 - manual settings (Windows) 32
 - problem-solving
 - no response 112
 - slow response 113
 - product status 7
 - PS font list 8
- R**
- ready light
 - LCD control panel 4
 - touchscreen control panel 5
 - rear door
 - locating 3
 - recycling supplies 76
 - replacing toner cartridge 77
 - reports
 - Configuration Report 8
 - Demo Page 8
 - Menu Structure 8
 - Network Summary 8
 - PCL Font List 8
 - PCL6 Font List 8
 - PS Font List 8
 - Service Page 8
 - Supplies Status 8
 - Usage Page 8
 - Reports menu 8, 9
 - resize documents
 - Mac 46
 - Windows 40
 - restoring factory-set defaults 86
 - right arrow
 - LCD control panel 4
 - touchscreen control panel 5
- S**
- scale documents
 - Mac 46
 - Windows 40
 - serial number
 - locating 3
 - service page 8
 - settings
 - driver presets (Mac) 43
 - drivers 24
 - drivers (Mac) 26
 - factory-set defaults, restoring 86
 - network report 8
 - setup button 4
 - touchscreen control panel 7
 - shortcuts (Windows)
 - creating 29
 - using 28
 - sleep delay
 - disabling 71
 - enabling 71
 - slot for security cable
 - locating 3
 - software
 - HP Utility for Mac 67
 - HP Web Jetadmin 68
 - problems 123
 - uninstalling for Mac 128
 - uninstalling for Windows 127
 - solving
 - walk-up USB printing
 - problems 114
 - solving problems
 - checklist 84
 - control panel messages 88
 - with paper feeds 97
 - special paper for covers
 - printing (Mac) 46
 - printing (Windows) 38
 - status
 - Home screen, control panel 7
 - HP Utility, Mac 67
 - supplies, printing report 8
 - storing
 - toner cartridges 76
 - subnet mask 61
 - supplies
 - counterfeit 130
 - low threshold settings 74
 - non-HP 130
 - ordering 129, 130
 - part numbers 130
 - recycling 76
 - replacing toner cartridge 77
 - status, viewing with HP Utility
 - for Mac 67
 - using when low 74
 - supplies button 7

supplies status page 8
printing 107

T

TCP/IP

manually configuring IPv4
parameters 61

toner cartridge

checking for damage 108
checking status 107
door release, locating 2
low threshold settings 74
part numbers 130
replacing 77
supplies status page 8
using when low 74

toner cartridges

non-HP 130
recycling 76
storage 76

touchscreen control panel

buttons and lights 5
Home screen 7

touchscreen display 5

transparencies

types supported 14

Tray 1

jams, clearing 98
loading 15
locating 2

Tray 2

loading 15
locating 2

Tray 3

loading 15

trays

jams, clearing 100, 102
supported paper sizes 12
supported paper types 14

troubleshooting

checklist 84
control panel messages 88
jams 97
Mac problems 125
network problems 117
paper feed problems 97
USB connection 116
walk-up USB printing
problems 114
Windows problems 123

wired network 117

wireless network 119

two-sided printing

automatic settings (Mac) 43

automatic settings (Windows)
31

manual settings (Mac) 44

manual settings (Windows) 32

types of paper supported 14

U

uninstalling Mac software 128

uninstalling Windows software
127

usage page 8

USB button 7

USB cable, part number 130

USB connection

troubleshooting 116

USB port

locating 3

USB storage accessories

printing from 55

W

walk-up USB port

locating 2

walk-up USB printing 55

watermarks

printing (Mac) 49

printing (Windows) 48

Web Services

applications 60

enabling 60

Web Services button 7

Web sites

fraud reports 130

ordering supplies 129

Windows

driver settings 24

wireless button 7

wireless diagnostic test 121

wireless light 5

wireless network

diagnostic test 121

troubleshooting 119

wireless network interference 122



CF270-90908

