

SyncMaster 650TS-2

LCD Display

User Manual

The color and the appearance may differ depending on the product, and the specifications are subject to change without prior notice to improve the performance.



Safety Instructions

Notational



Note

These safety instructions must be followed to ensure your safety and prevent property damage.

Make sure to read the instructions carefully and use the product in the correct manner.

Warning / Caution



Failure to follow directions noted by this symbol could result in bodily harm or damage to the equipment.

Note



Prohibited



Important to read and understand at all times



Do not disassemble



Disconnect the plug from the outlet



Do not touch



Ground to prevent an electric shock

Power





When not used for extended period of time, set your computer to DPM.

If using a screen saver, set it to active screen mode.

The images here are for reference only, and are not applicable in all cases (or countries).

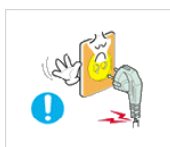
Shortcut to Anti-Afterimage Instructions



 Do not use a damaged power cord or plug or a damaged or loose power outlet.

- Otherwise, this may result in electric shock or fire.



 Do not touch the power plug with wet hands when removing or plugging the plug into the outlet.

- Otherwise, this may result in electric shock.

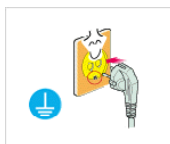

 Make sure to connect the power cord to a grounded power outlet.

- Otherwise, it may result in electric shock or personal injury.
-

Safety Instructions

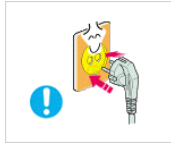

▶ Ensure that the power plug is plugged into the power outlet firmly and correctly.

- Otherwise, this may result in fire.

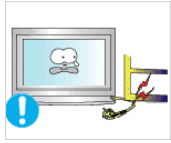

▶ Do not forcefully bend or pull the power plug and do not place any heavy material on it.

- Otherwise, this may result in fire.

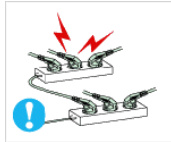

▶ Do not connect multiple appliances to the same power outlet.

- Otherwise, this may cause fire due to overheating.

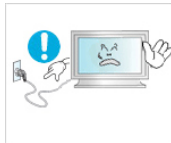

▶ Do not disconnect the power cord while using the product.

- Otherwise, this may result in damage to the product due to electric shock.



▶ To disconnect the apparatus from the mains, the plug must be pulled out from the mains socket, therefore the mains plug shall be readily operable.

- Otherwise, this may cause electric shock or fire.



▶ Use only the power cord provided by our company. Do not use the provided power cord of another product.

- Otherwise, this may result in fire or electric shock.

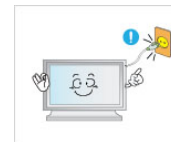

▶ Connect the power plug to a wall outlet that can be easily reached.

- When a problem occurs with the product, you must unplug the power plug to cut the power off completely. You cannot cut the power off completely using only the power button on the product.

Installation



Be sure to contact an authorized Service Center when installing your monitor in a location with heavy dust, high or low temperatures, high humidity, and exposed to chemical substances and where it operates for 24 hours such as at airports, train stations etc.

Failure to do so may cause serious damage to your monitor.



▶ Ensure that at least two persons lift and move the product.

- Otherwise, it may be dropped and cause personal injury, and/or damage the product.

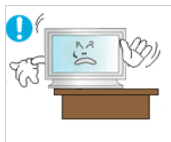

▶ When installing the product in a cabinet or rack, make sure that the front end of the bottom of the product does not project out.

- Otherwise, it may fall or cause personal injury.
-

- Use a cabinet or rack of a size appropriate to the product.

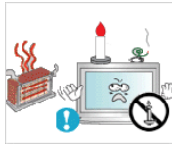

▶ **DO NOT PLACE CANDLES, MOSQUITO REPELLANT, CIGARETTES AND ANY HEATING APPLIANCES NEAR THE PRODUCT.**

- Otherwise, this may result in fire.

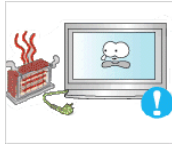

▶ **Keep heating appliances as far away from the power cord or the product as possible.**

- Otherwise, this may result in electric shock or fire.



▶ **Do not install it in a badly ventilated location such as a bookcase or closet.**

- Otherwise, this may result in fire due to an increase in the internal temperature.



▶ **When putting the product down, make sure to put it down softly.**

- Otherwise, this may result in damage to the screen display.



▶ **Do not place the front of the product on the floor.**

- Otherwise, this may result in damage to the screen display.



▶ **Ensure that an authorized installation company installs the wall mount.**

- Otherwise, it may fall and cause personal injury.

- Make sure to install the specified wall mount.

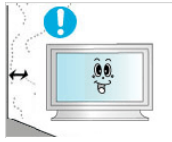

▶ **Install your product in a well ventilated location. Ensure that there is a clearance of more than 4 inches (10 cm) from the wall.**

- Otherwise, it may result in fire due to an increase in the internal temperature.

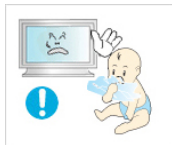

▶ **Ensure that the packaging vinyl is kept away from children.**

- Otherwise, it may result in serious harm (suffocation) if children play with it.

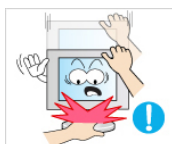

▶ **If the height of your monitor is adjustable, do not place any object or part of your body on the stand when lowering it.**

- This may cause damage to the product or the person carrying it.

Clean



When cleaning the monitor case or the surface of the TFT-LCD screen, wipe with a slightly moistened, soft fabric.

Safety Instructions



- ▶ Do not spray cleaner directly onto the surface of the product.
- Otherwise, this may result in the discoloration and distortion of the structure and the screen surface may peel off.



- ▶ When cleaning the power plug pins or dusting the power outlet, clean it with a dry cloth.
- Otherwise, it may result in fire.



- ▶ When cleaning the product, make sure to disconnect the power cord.
- Otherwise, it may result in electric shock or fire.

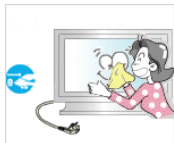

- ▶ When cleaning the product, disconnect the power cord and clean it softly with a dry cloth.
- (Do not use chemicals such as wax, benzene, alcohol, thinner, mosquito repellent, lubricant, or cleaner.) These may change the appearance of the product surface and peel off the indication labels on the product.

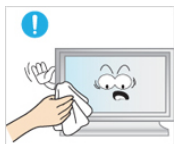

- ▶ Since the product housing is easily scratched, make sure to use the specified cloth only.

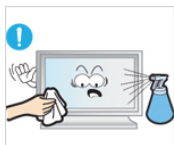

- ▶ When cleaning the product, do not spray water directly onto the main body of the product.
- Ensure that water does not enter the product and that it is not wet.
- Otherwise, this may result in electric shock, fire or a malfunction.

Others

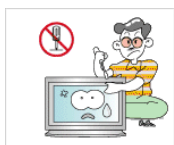

- ▶ The product is a high voltage product. Do not disassemble, repair or modify the product yourself.
- Otherwise, this may result in electric shock or fire. If the product needs to be repaired, contact a Service Center.

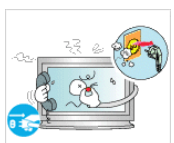

- ▶ If there is a strange smell or a strange sound or smoke is coming from the product, disconnect the power plug immediately and contact a Service Center.
- Otherwise, this may result in electric shock or fire.

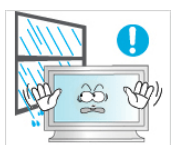

- ▶ Do not place this product in a location exposed to moisture, dust, smoke, water, or in a car.
 - Otherwise, this may result in electric shock or fire.
-

Safety Instructions



▶ When you drop the product or the case is broken, turn the power off and disconnect the power cord. Contact a Service Center.

- Otherwise, this may result in electric shock or fire.



▶ If thunder or lightning is occurring, do not touch the power cord or antenna cable.

- Otherwise, this may result in electric shock or fire.



▶ Do not try to move the monitor by pulling only the wire or the signal cable.

- Otherwise, it may fall and result in electric shock, damage to the product or fire due to damage to the cable.

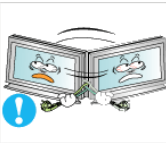

▶ Do not lift or move the product back and forwards or right and left while only holding the power cord or signal cables.

- Otherwise, it may fall and result in electric shock, damage to the product or fire due to damage to the cable.

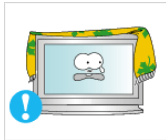

▶ Make sure that the ventilating opening is not blocked by a table or curtain.

- Otherwise, it may result in fire due to an increase in the internal temperature.

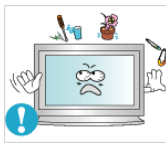

▶ Do not place any containers containing water, vases, flower-pots, medicines as well as any metal on the product.

- If water or a foreign material enters the product, disconnect the power cord and contact a Service Center.

- This may result in a product malfunction, electric shock, or fire.

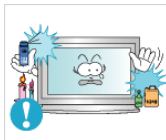

▶ Do not use or keep combustible spray or flammable material near the product.

- Otherwise, this may result in an explosion or fire.



▶ Do not insert any metal, such as chopsticks, coins, pins and steel, or flammable objects, such as matches or paper, inside the product (through the ventilating openings, input and output terminals, etc).

- If water or foreign material enters the product, disconnect the power cord and contact a Service Center.

- Otherwise, this may result in electric shock or fire.



▶ When using a fixed screen for a long time, an afterimage or stain may occur.

- If you are not using your product for a long period of time, put it into sleep mode or use a moving screen saver.



▶ Set a resolution and frequency appropriate to the product.

- Otherwise, your eyesight may be damaged.
-

Safety Instructions



▶ When using headphones or earphones, do not turn the volume too high.

- Having the sound too loud may damage your hearing.



▶ To avoid eyestrain, do not sit too close to the product.



▶ Take a rest for at least five (5) minutes after using the monitor for one (1) hour.

This reduces eye fatigue.



▶ Do not install it in an unstable location such as an unstable rack or uneven surface or a location exposed to vibrations.

- Otherwise, it may fall and cause personal injury and/or damage the product.
- If you use the product in a location exposed to vibrations, it may damage the product and result in fire.



▶ When moving the product, turn the power off and disconnect the power plug, antenna cable, and all the cables connected to the product.

- Otherwise, it may result in electric shock or fire.

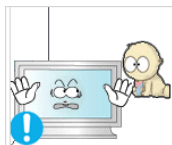

▶ Ensure that children do not hang onto the product or climb up onto the product.

- The product may fall and cause personal injury or death.



▶ If you do not use the product for a long period of time, disconnect the power cord from the power outlet.

- Otherwise, this may result in overheating or fire due to dust, and may result in fire due to electric shock or leakage.

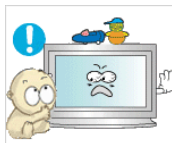

▶ Do not place any heavy items or toys or confectionery, such as cookies etc. that may attract the attention of children and to the product.

- Your children may hang onto the product causing it to fall and this may result in personal injury or death.



▶ Be careful that children do not place the battery in their mouths when removed from the remote control. Place the battery in a location that children or infants cannot reach.

- If children have had the battery in their mouths, consult your doctor immediately.

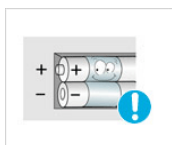

▶ When replacing the battery, insert it with the right polarity (+, -).

- Otherwise, the battery may become damaged or it may cause fire, personal injury or damage due to leakage of the internal liquid.
-

Safety Instructions



▶ Use only the specified standardized batteries, and do not use a new battery and a used battery at the same time.

- Otherwise, the batteries may be damaged or cause fire, personal injury or damage due to a leakage of the internal liquid.



▶ The batteries (and rechargeable batteries) are not ordinary refuse and must be returned for recycling purposes. The customer is responsible for returning the used or rechargeable batteries for recycling.

- The customer can return used or rechargeable batteries to a nearby public recycling center or to a store selling the same type of the battery or rechargeable battery.



▶ Do not place the product in a location exposed to direct sunlight or near any heat such as a fire or heater.

- This may reduce the lifetime of the product, and may result in fire.



▶ Do not drop any objects onto the product or cause any impact to the product.

- Otherwise, this may result in electric shock or fire.



▶ Do not use a humidifier near the product.

- Otherwise, this may result in electric shock or fire.

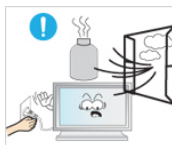

▶ When there is a gas leak, do not touch the product or the power plug; ventilate immediately.

- If a spark occurs, it may cause an explosion or fire.

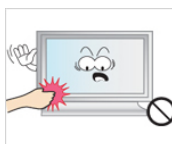

▶ If the product has been turned on for a long time, the display panel becomes hot. Do not touch it.



▶ Keep the small accessories in a location out of the reach of children.



▶ Be careful when adjusting the angle of the product or the height of the stand.

- This may result in personal injury as your hand or fingers may become caught.
- Also, if you tilt the product too far, it may fall and cause personal injury.



▶ Do not install the product in a location low enough for children to reach.

- Otherwise, it may fall and result in personal injury.
-

Safety Instructions

- Since the front part of the product is heavy, install the product on a level and stable surface.



- ▶ Do not put any heavy objects on the product.

- This may result in personal injury and/or damage to the product.



- ▶ Using an object other than the supplied stylus can leave scratches on the product.

- There is a possibility that using a pen which is too thin (i.e. ballpoint pen, sharp pencil, PDA pen, etc.) will not be recognized by the touch sensor due to limitations of the device. It is strongly recommended that you use the supplied stylus pen.
-

Introduction

Package Contents

Checking the Contents of the Package

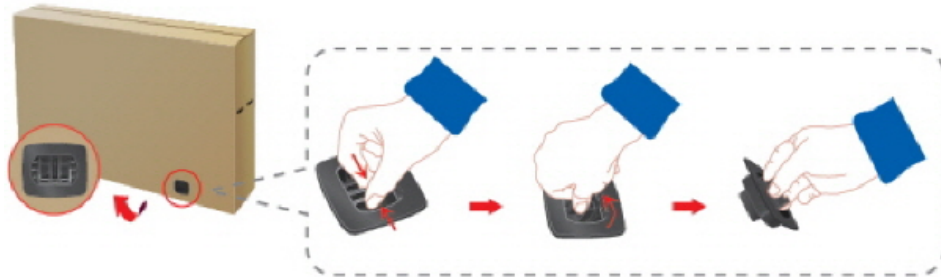

Remove the lock from the package box, as shown in the figure above.



Lift up the package box by holding the grooves on both sides of the package box.

Check the contents of the package.

Remove the Styrofoam and vinyl cover.

Note

- After unpacking the package, make sure to check the contents of the package.
- Store the packaging box in case you need to move the Product later.
- If any items are missing, contact your dealer.
- Contact a local dealer to purchase optional items.

Unpacking



LCD Display

Manuals



Quick Setup Guide



Warranty Card
(Not available in all locations)



User Manual, Samsung Interactive whiteboard

Cables



Power Cord



USB Cable



D-Sub Cable

Others



Remote Control
(BP59-00138A)



Batteries (AAA X 2)
(Not available in all locations)



Stylus pens (x3)

Sold separately



DVI Cable



D-Sub to BNC Cable

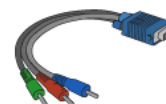

D-Sub to Component Cable

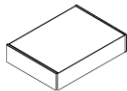

Wall Mount KIT



Semi Stand KIT



Network Box

Your LCD Display

Front



① *MENU button [MENU]*

Opens the on-screen menu and exits from the menu. Also use to exit the OSD menu or return to the previous menu.

② *Navigate buttons (Up-Down buttons)*

Moves from one menu item to another vertically or adjusts selected menu values.

③ *Adjust buttons (Left-Right buttons) / Volume buttons*

Moves from one menu item to another horizontally or adjusts selected menu values. When OSD is not on the screen, press the button to adjust volume.

④ *ENTER button [ENTER]*

Activates a highlighted menu item.

⑤ *SOURCE button [SOURCE]*

Switches from PC mode to Video mode. Selects the input source that an external device is connected to.

[PC] [DVI] [AV] [Component] [HDMI]

⑥ *PIP button*

Push the PIP button to turn the PIP screen On / Off.

- **PC : DVI / AV/ HDMI**
- **DVI : PC**
- **AV : PC**
- **HDMI : PC**

 **Note**

When the **PIP** function is activated on the monitor, the touchscreen function may not work properly.

7 *Power button* [

Use this button for turning the LCD Display on and off.

8 *Brightness Sensor (Optional)*

Automatically detects the surrounding brightness.

 **Note**

This function is activated only on the models equipped with an auto brightness sensor.

9 *Power indicator*

Shows PowerSaver mode by blinking green

 **Note**

See PowerSaver described in the manual for further information regarding power saving functions. For energy conservation, turn your LCD Display OFF when it is not needed or when leaving it unattended for long periods.

10 *Remote Control Sensor*

Aim the remote control towards this spot on the LCD Display.

Rear

 **Note**

For detailed information concerning cable connections, refer to Connecting Cables under Setup. The LCD Display 's configuration at the back may vary slightly depending on the model.



A

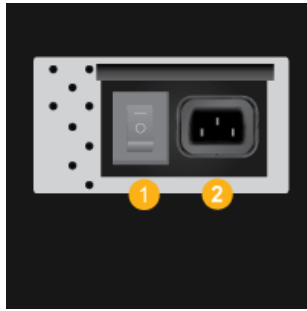

1 POWER SW ON [] / OFF [O]

Switches the LCD Display On/Off.

2 POWER

The power cord plugs into the LCD Display and the wall outlet.

B

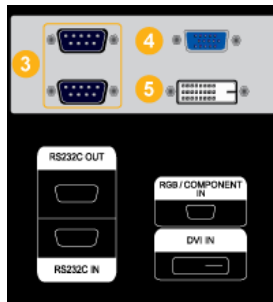

3 RS232C OUT/IN (RS232C Serial PORT)

MDC(Multiple Display Control) Program Port

4 RGB/COMPONENT IN (PC/COMPONENT Connection Terminal (Input))

- Connect the [RGB/COMPONENT IN] port on the monitor to the RGB port on the PC using the D-SUB cable.
- Connect the [RGB/COMPONENT IN] port on the monitor to the COMPONENT port on the external device using the D-Sub to Component Cable.
- Connect the [RGB/COMPONENT IN] port on the monitor to the BNC port on the PC using the D-Sub to BNC Cable.

5 DVI IN (PC Video Connection Terminal)

Connect the [DVI IN] port on the monitor to the DVI port on the PC using the DVI cable.

C

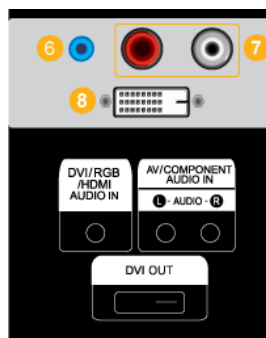

6 DVI/RGB/HDMI AUDIO IN (PC/DVI/HDMI(PC) Audio Connection Terminal (Input))

7 AV/COMPONENT AUDIO IN [L- AUDIO- R]

Connect the port of the DVD, VCR (DVD / DTV Set-Top Box) to the [AV/COMPONENT AUDIO IN [L- AUDIO- R]] port of the LCD Display.

8 DVI OUT

- Connect a monitor to another monitor through a DVI cable.
- Connect the [DVI OUT] port on the monitor to the [HDMI IN] port on the other monitor using the DVI to HDMI cable.
- DVI, HDMI and network signals sent via the [DVI OUT] port are displayed on the second display which has the DVI IN port.

 **Note**

Up to 6 Full HD or 10 HD monitors can be connected (May differ depending on the product).

D

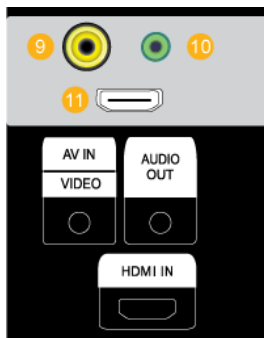

9 *AV IN [VIDEO]*

Connect the [AV IN [VIDEO]] terminal of your monitor to the video output terminal of the external device using a VIDEO cable.

10 *AUDIO OUT*

Headphone/External speaker output terminal.

11 *HDMI IN*

Connect the HDMI terminal at the back of your LCD Display to the HDMI terminal of your digital output device using a HDMI cable.

Up to HDMI cable 1.0 can be supported.

E

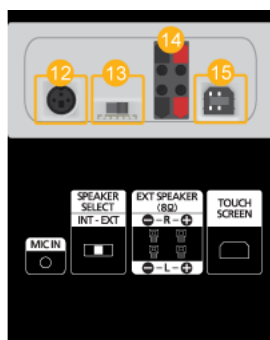

12 *MIC IN*

Use a wireless microphone by connecting a wireless microphone sensor unit to this port.

13 *SPEAKER SELECT [INT - EXT]*

Select between the internal and external speakers.

- INT - Select to use the internal speaker.
- EXT - Select to use a pair of external speakers.

**Note**

The external speakers are optional.

To enable the connected external speakers, set **Speaker Select** under the **Sound** menu to **External** (on screen).

14 EXT SPEAKER(8)[- L - +, - - R - +]
(Speaker ports)

15 TOUCH SCREEN

Connect to the PC using the USB cable in order to use the TOUCH function under PC mode.

**Note**

See Connecting Cables for further information regarding cable connections.

Remote Control**Note**

The performance of the remote control may be affected by a TV or other electronic device operating near the LCD Display, causing a malfunction due to interference with the frequency.

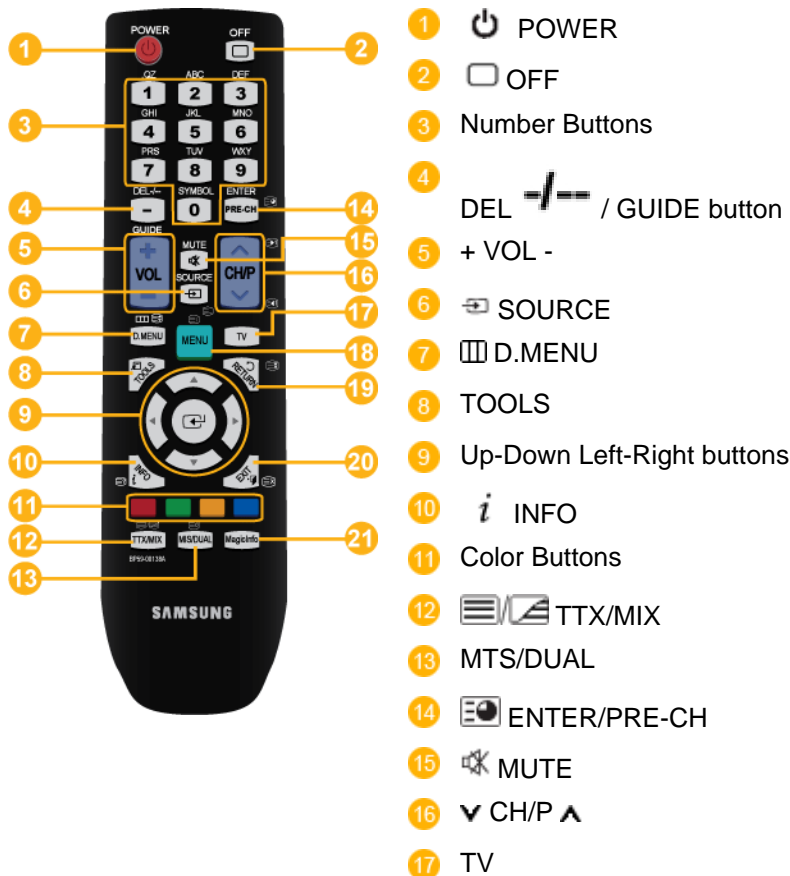









18  MENU

19  RETURN

20  EXIT

21 MagicInfo

1.  POWER Turns the product On.
2.  OFF Turns the product Off.
3. Number Buttons Press to change the channel.
4. DEL  / GUIDE button The "-" button is used to select Digital channels. Electronic Program Guide (EPG) display.
- This function does not work for this LCD Display.
5. + VOL - Adjusts the audio volume.
6.  SOURCE Press the button to change the input signal SOURCE.
Changing the SOURCE is only allowed for external devices that are connected to the LCD Display at the time.
7.  D.MENU DTV menu display
- This function does not work for this LCD Display.
8. TOOLS Use to quickly select frequently used functions.
- This function does not work for this LCD Display.
9. Up-Down Left-Right buttons Moves from one menu item to another horizontally, vertically or adjusts selected menu values.
10.  INFO Current picture information is displayed on the upper left corner of the screen.
11. Color Buttons Press to add or delete channels and to store channels to the favorite channel list in the "Channel List" menu.
- This function does not work for this LCD Display.
12.  TTX/MIX TV channels provide written information services via teletext.
- Teletext Buttons
 6, 7, 10, 12, 13, 14, 16, 18, 19, 20
- This function does not work for this LCD Display.
13. MTS/DUAL - This function does not work for this LCD Display.
MTS-
You can select MTS (Multichannel Television Stereo) mode.



Audio Type MTS/S_Mode Default

FM Stereo	Mono	Mono		Manual
	Stereo	Mono	Stereo	Change
	SAP	Mono	SAP	Mono



DUAL-

STEREO/MONO, DUAL I / DUAL II and MONO/NICAM MONO/NICAM STEREO can be operated depending on the broadcasting type by using the DUAL button on the remote control while watching TV.

- | | |
|--|--|
| 14.  ENTER/PRE-CH | This button is used to return to the immediately previous channel.

- This function does not work for this LCD Display. |
| 15.  MUTE | Pauses (mutes) the audio output temporarily. This is displayed on the lower left corner of the screen. The audio comes back on if MUTE or - VOL + is pressed in the Mute mode. |
| 16.  CH/P  | In TV mode, selects TV channels.

- This function does not work for this LCD Display. |
| 17. TV | Selects the TV mode directly.

- This function does not work for this LCD Display. |
| 18.  MENU | Opens the on-screen menu and exits from the menu or closes the adjustment menu. |
| 19.  RETURN | Returns to the previous menu. |
| 20.  EXIT | Exits from the menu screen. |
| 21. MagicInfo | MagicInfo Quick Launch Button. |

Mechanical Layout

Mechanical Layout

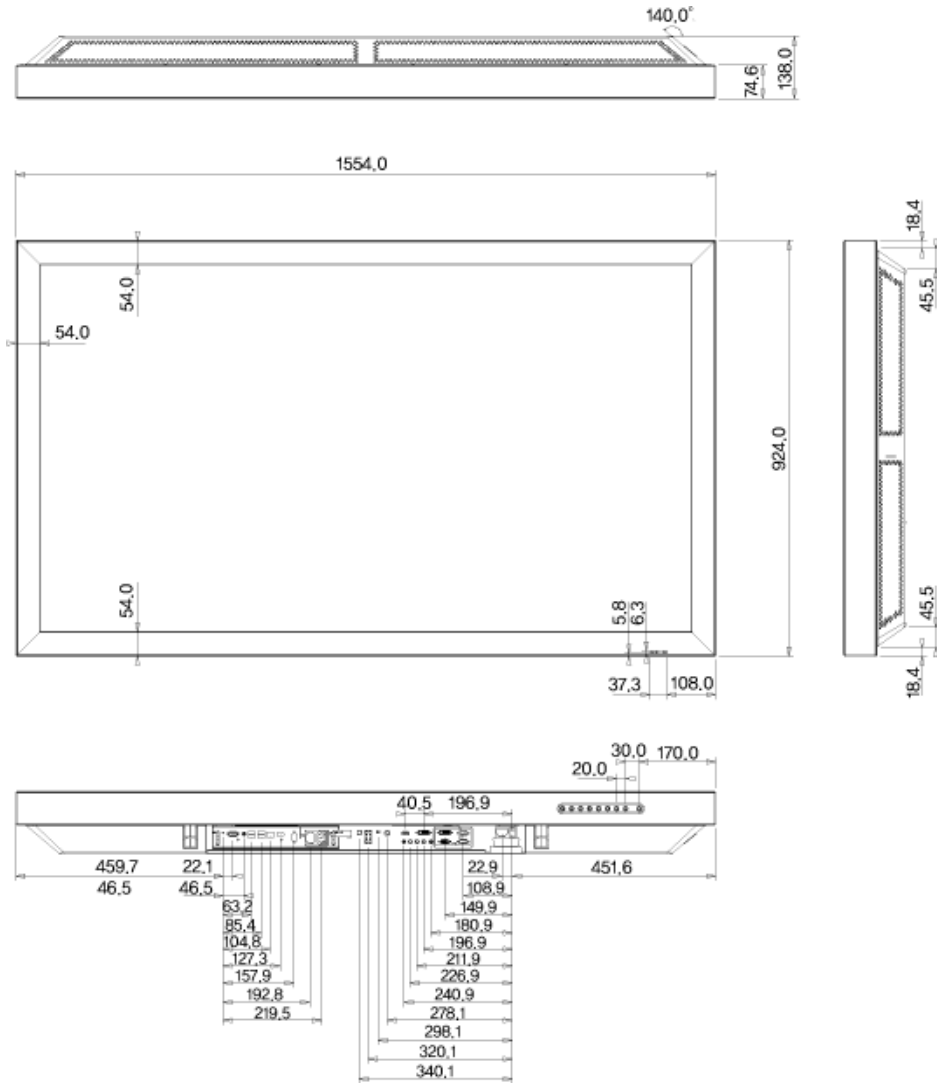

Installation VESA Bracket

- When installing VESA, make sure to comply with the international VESA standards.
- Purchasing VESA Bracket and Installation Information : Please contact your nearest SAMSUNG Distributor to place an order. After your order is placed, installation professionals will visit you and install the bracket.
- At least 2 persons are needed in order to move the LCD Display.
- SAMSUNG is not responsible for any product damage or any injury caused by installation at customer's discretion.

Dimensions

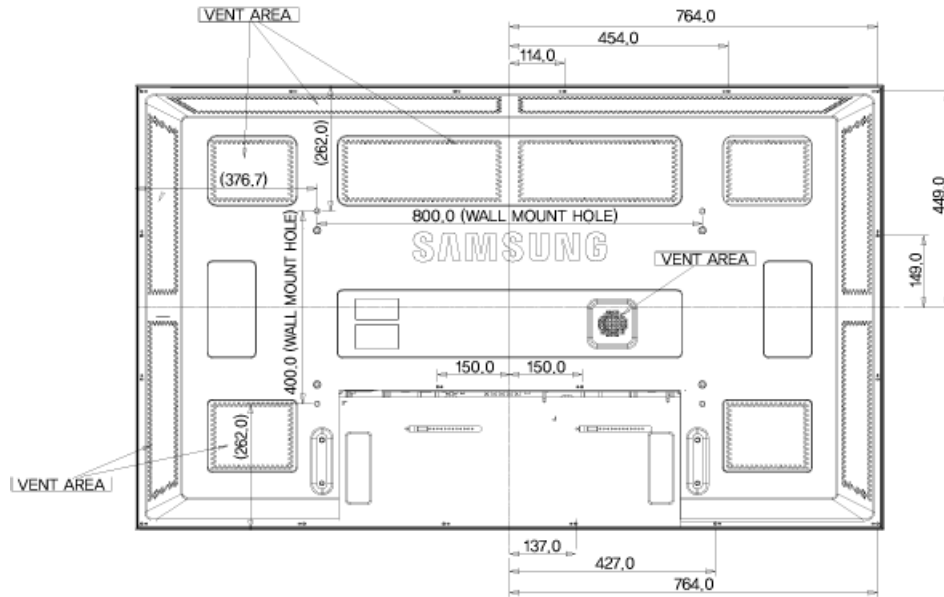

Notice

For securing the bracket on a wall, use only machine screws of 6 mm diameter and 8 to 12 mm length.

Wall Bracket Installation

- Contact a technician for installing the wall bracket.
- SAMSUNG Electronics is not responsible for any damages to the product or harm to customers when the installation is done by the customer.
- This product is for installing on cement walls. The product may not stay in place when installed on plaster or wood.

Components

Only use the components and accessories shipped with the product.

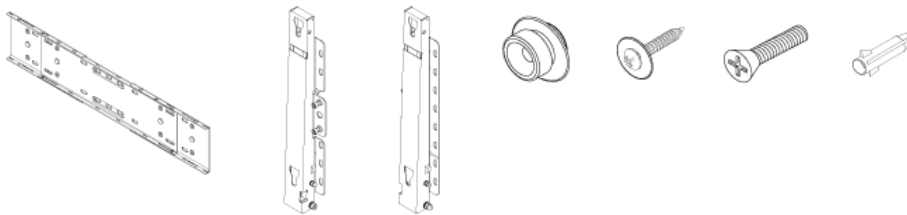

Wall Bracket(1)

Hinge(Left 1, Right
1) Plastic
Hanger
(4)

Screw
(A)(11)

Screw
(B)(4)

Anchor
(11)

Wall Bracket Assembly



Note

There are two hinges(left and right). Use the correct one.

1. Insert and tighten the Captive Screw in the direction of the arrow.

When done, mount the wall bracket on the wall.

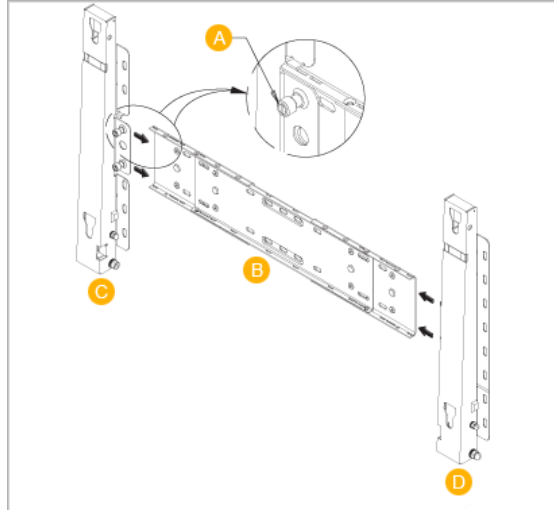

There are two hinges(left and right). Use the correct one.

- A - Captive Screw
- B - Wall Bracket
- C - Hinge (Left)
- D - Hinge (Right)

2. Before drilling into the wall, check if the length between the two locking holes at the back of the product is correct.

If the length is too short or long, loosen all or some of the 4screws on the wall bracket to adjust the length.

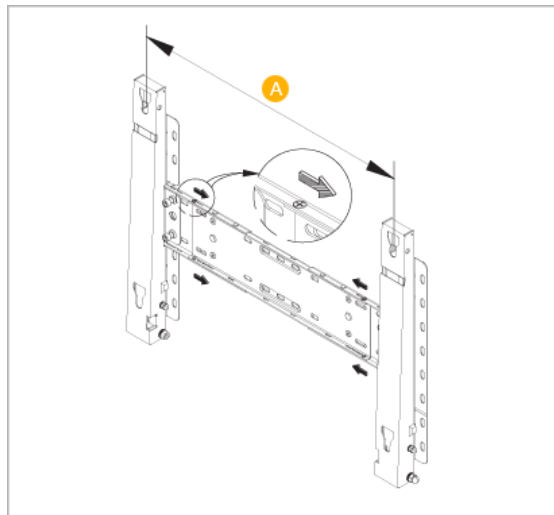

- A - Length between the two locking holes

3. Check the installation diagram and mark the drill points on the wall. Use the 5.0 mm bit to drill holes deeper than 35 mm. Fix each anchor in the corresponding hole. Match each of the brackets and hinge holes to the corresponding anchor holes and insert and tighten the 11 screws A.
-

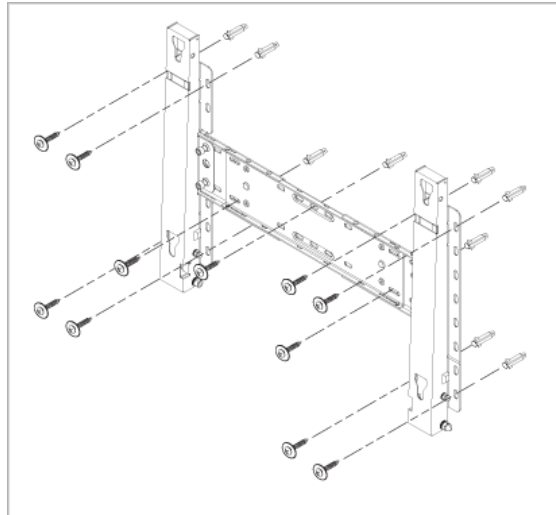

To mount the product on the wall bracket

The shape of the product may vary depending on the model. (The assemblies of the plastic hanger and the screw are the same)

1. Remove the 4 screws on the back of the product.

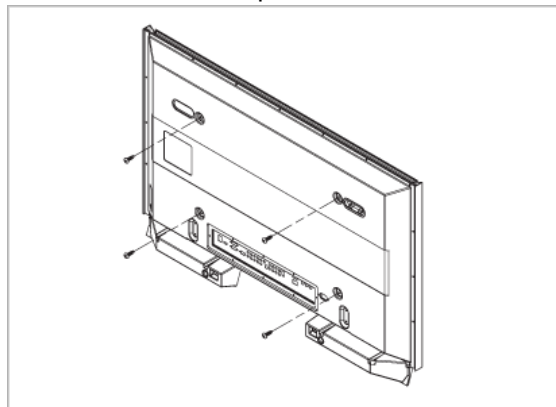

2. Insert the screw B into the plastic hanger.

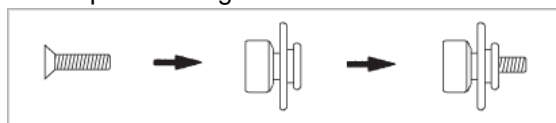

Notice

- Mount the product on the wall bracket and make sure it is properly fixed to the left and right plastic hangers.
 - Be careful when installing the product on the bracket as fingers can be caught in the holes.
 - Make sure the wall bracket is securely fixed to the wall, or the product may not stay in place after installation.
3. Tighten the 4 screws in step 2 (plastic hanger + screw B) to the rear holes of the product.
-

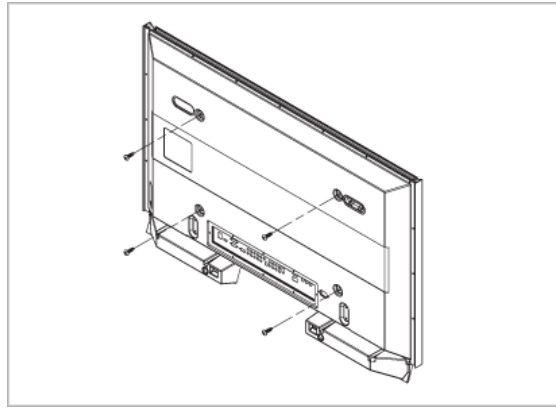

4. Remove safety pin (3) and insert the 4 product holders into the corresponding bracket holes (1). Then place the product(2) so that it is firmly fixed to the bracket. Make sure to re-insert and tighten the safety pin (3) to securely hold the product to the bracket.

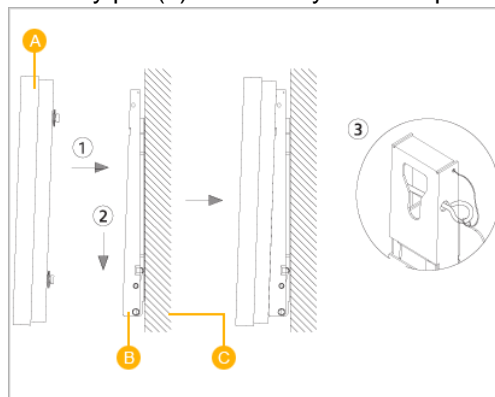

- A - LCD Display
- B - Wall Bracket
- C - Wall

Wall Bracket Angle Adjustment

Adjust the bracket angle to -2° before installing it on the wall.

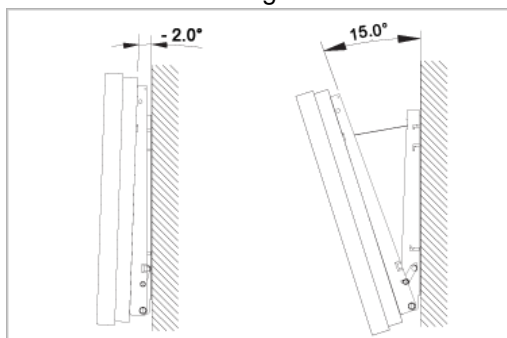

1. Fix the product to the wall bracket.
 2. Hold the product at the top in the center and pull it forward (direction of the arrow) to adjust the angle.
 3. You can adjust the bracket angle between -2° and 15° .
-

Introduction

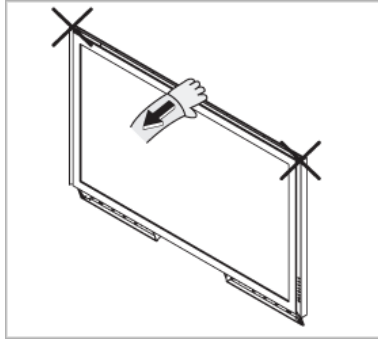

Make sure to use the top center, and not the left or the right side of the product to adjust the angle.

Connections

Connecting a Computer

- AV input devices such as DVD players, VCRs or camcorders as well as your computer can be connected to the LCD Display. For detailed information on connecting AV input devices, refer to the contents under Adjusting Your LCD Display.
- The LCD Display 's configuration at the back may vary slightly depending on the LCD Display model.

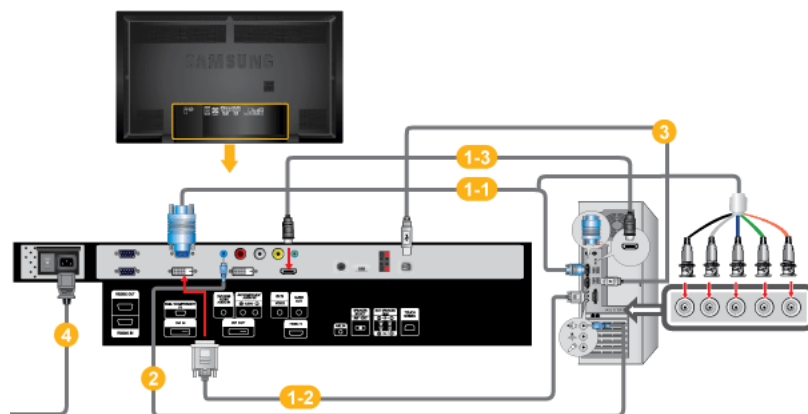

- 1 There are several ways to connect the computer to the monitor. Choose one from the following options.

1-1 Using the D-sub (Analog) connector on the video card.

- Connect the D-sub to the 15-pin, [RGB/COMPONENT IN] port on the back of your LCD Display and the 15 pin D-sub Port on the computer.

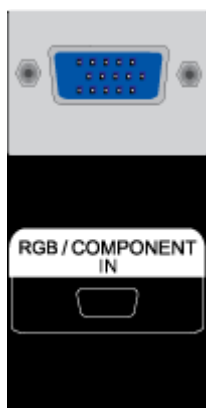

1-2 Using the DVI (Digital) connector on the video card.

- Connect the DVI Cable to the [DVI IN] port on the back of your LCD Display and the DVI port on the computer.
-

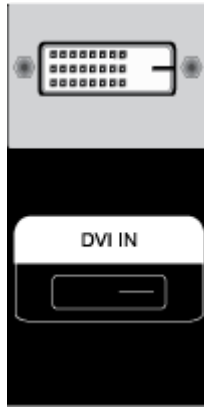

1-3 Using the HDMI (digital) output on the graphics card.

- Connect the [HDMI IN] port on the monitor to the HDMI port on the PC using the HDMI cable.

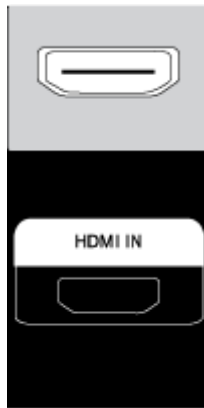

 **Note**

When the HDMI cable to the PC, ensure that you select **HDMI** from both the **Source List** and **Edit Name** before selecting **PC** or **DVI** device so that normal PC screen and sound can be outputted. Note that sound is only available when connected according to the option **2** that follows.

- 2** Connect the audio cable for your LCD Display to the audio port on the back of the LCD Display.
- 3** To use the touchscreen function while connected to your PC, connect a USB cable to the USB ports on the product and PC.
- 4** Connect the power cord for your LCD Display to the power port on the back of the LCD Display. Turn on the power switch.

 **Note**

- Turn on both your computer and the LCD Display.
 - Contact a local SAMSUNG Electronics Service Center to buy optional items.
-

Connecting to Other devices

- AV input devices such as DVD players, VCRs or camcorders as well as your computer can be connected to the LCD Display. For detailed information on connecting AV input devices, refer to the contents under Adjusting Your LCD Display.
- The LCD Display 's configuration at the back may vary slightly depending on the LCD Display model.

Connecting AV Devices

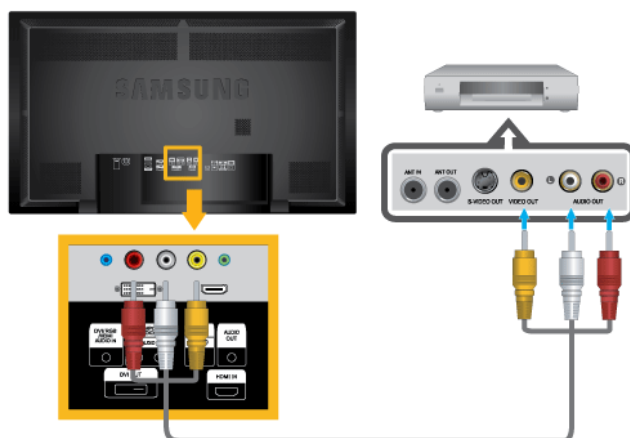

1. Connect the Video and Audio [AV/COMPONENT AUDIO IN [L-AUDIO-R]] port of the DVD, VCR or DTV Set-Top Box to the Video and Audio [AV IN [VIDEO]]LCD Display.
2. Play the DVD, VCR or Camcorder with a DVD disc or tape inserted.
3. Select **AV** using the SOURCE button on the front of the LCD display or on the remote.

Connecting to a Camcorder

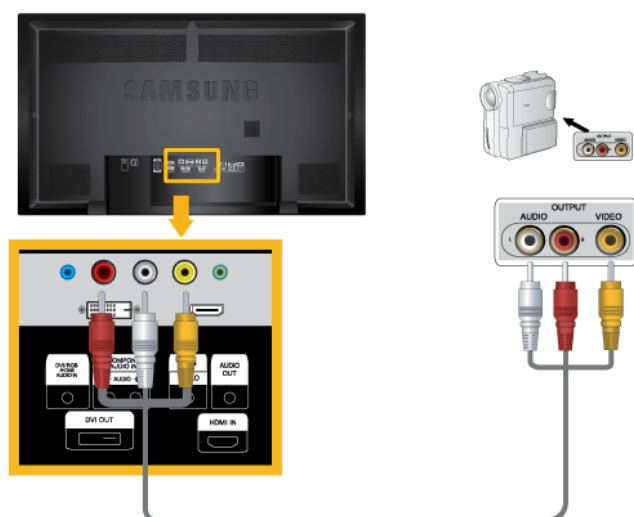

1. Locate the AV output jacks on the camcorder. They are usually found on the side or back of the camcorder. Connect a set of audio cables between the AUDIO OUTPUT jacks on the camcorder and the [AV/COMPONENT AUDIO IN [L-AUDIO-R]] on the LCD Display .
2. Connect a video cable between the VIDEO OUTPUT jack on the camcorder and the [AV IN [VIDEO]] on the LCD Display .

3. Select **AV** for the Camcorder connection using the SOURCE button on the front of the LCD Display or on the remote control.
4. Then, start the Camcorder with a tape inserted.

 **Note**

The audio-video cables shown here are usually included with a Camcorder. (If not, check your local electronics store.) If your camcorder is stereo, you need to connect a set of two cables.

Connecting Using a DVI Cable

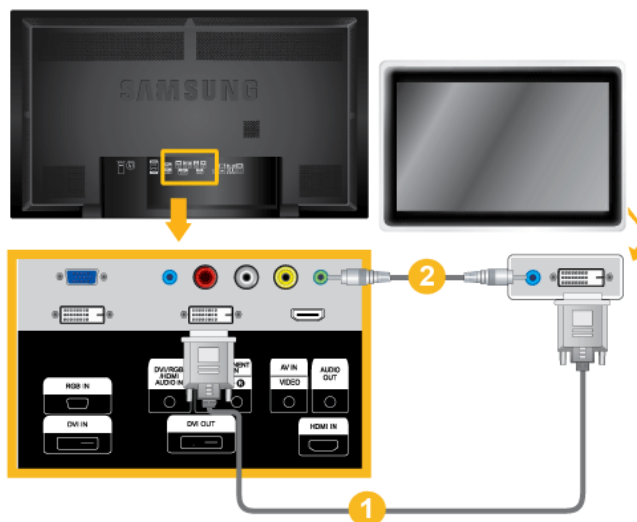

1. Connect between the [DVI OUT] port on the LCD Display and the input port on another monitor using a DVI cable.
2. Connect between the [AUDIO OUT] port on the LCD Display and the audio input port on another monitor using a stereo cable.
3. Select **DVI** using the SOURCE button on the front of the LCD Display or on the remote control.

 **Note**

DVI OUT does not support HDCP.

Connecting Using a HDMI Cable

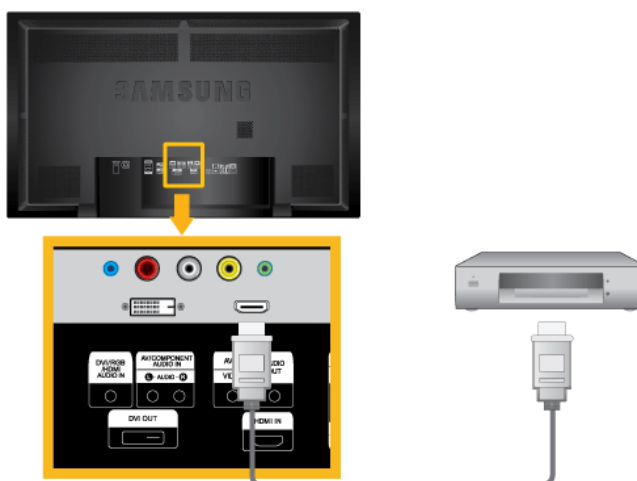

1. Connect input devices such as a Blu-Ray/DVD player to the [HDMI IN] terminal of the LCD Display using an HDMI cable.
2. Select **HDMI** using the SOURCE button on the front of the LCD Display or on the remote control.

 **Note**

In **HDMI** mode, only PCM format audio is supported.

Connecting Using a DVI to HDMI Cable

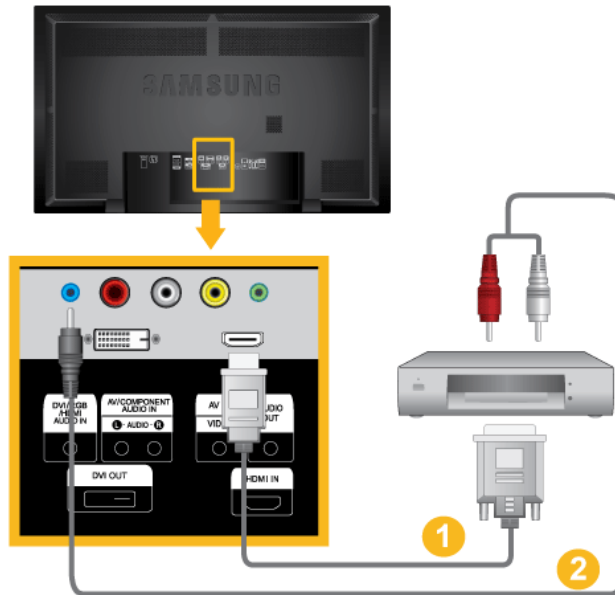

1. Connect the DVI output terminal of a digital output device to the [HDMI IN] terminal of the LCD Display using a DVI to HDMI cable.
 2. Connect the red and white jacks of an RCA to stereo (for PC) cable to the same colored audio output terminals of the digital output device, and connect the opposite jack to the [DVI / RGB / HDMI AUDIO IN] terminal of the LCD Display.
 3. Select **HDMI** using the SOURCE button on the front of the LCD Display or on the remote control.
-

Connecting a DVD Player

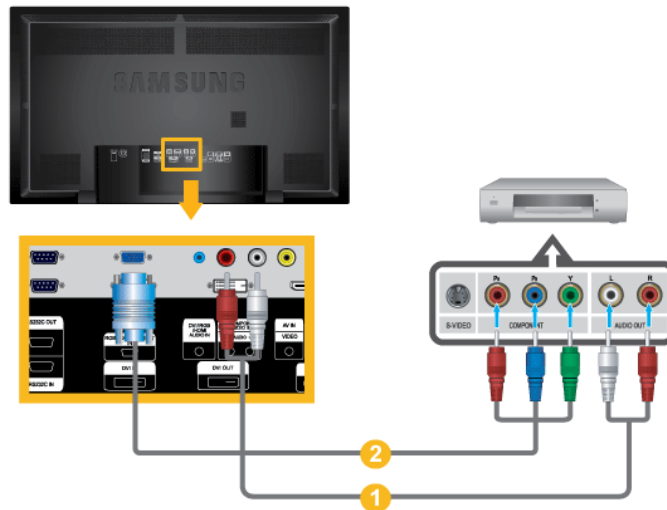

1. Connect a set of audio cables between the [AV/COMPONENT AUDIO IN [L-AUDIO-R]] on the LCD Display and the AUDIO OUT jacks on the DVD player.
2. Connect the D-Sub to Component cable to the [RGB/COMPONENT IN] ports on the monitor.

Note

- Select **Component** for the connection to a DVD player using the SOURCE button on the front of the LCD Display or on the remote control.
- Then, start the DVD Player with a DVD disc inserted.
- The D-Sub to Component cable is optional.
- For an explanation of Component video, consult your DVD manual.

Connecting a DTV Set Top (Cable/Satellite) Box

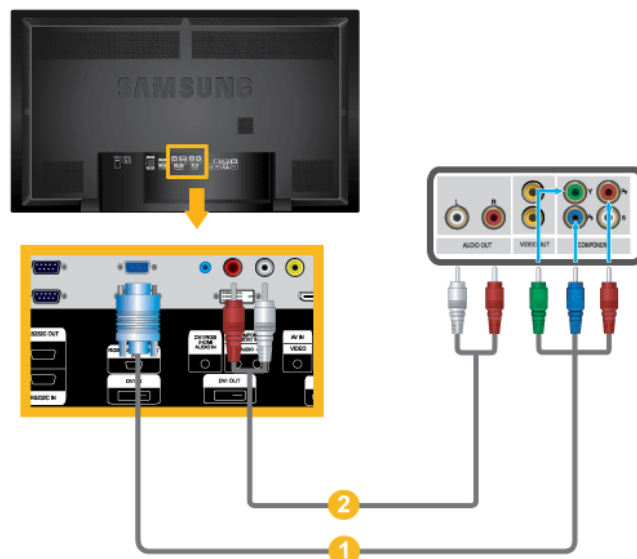

1. Connect the [RGB/COMPONENT IN] ports on the monitor to the P_R, Y, P_B ports on the set-top box using the D-Sub to Component cable.
2. Connect a set of audio cables between the [AV COMPONENT AUDIO IN [L-AUDIO-R]] on the LCD Display and the AUDIO OUT jacks on the Set Top Box.

 **Note**

- Select **Component** using the SOURCE button on the front of the LCD Display or on the remote control.
- For an explanation of Component video, see your Set Top Box owner's manual.

Connecting to an Audio System

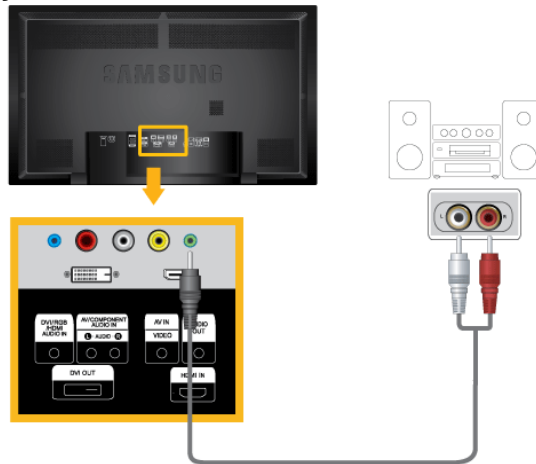

1. Connect a set of audio cables between the AUX L, R jacks on the AUDIO SYSTEM and [AUDIO OUT] on LCD Display.

Connecting a wireless microphone



1. Connect a wireless microphone sensor unit to [MIC IN] on the monitor.

 **Note**

To use a wireless microphone, **Wireless MIC** must be set to **On** in the **Sound** menu.

Using the Software

MDC (Multiple Display Control)



Installation

1. Insert the installation CD into the CD-ROM drive.
2. Click the MDC installation file.
 **Note**
If the popup window to install the software for the main screen is not displayed, proceed with the installation using the MDC executable file on the CD.
3. When the Installation Shield Wizard window appears, click "Next".
4. Select "I agree to the terms of the license agreement" to accept the terms of use.
5. Click "Install".
6. The "Installation Status" window appears.
7. Click "Finish".
8. When the installation is complete, the MDC executable icon appears on your desktop. Double-click the icon to start the program.

MDC execution icon may not appear depending on specification of computer system or monitor. If that happens, press F5 Key.

Installation Problems

The installation of MDC can be affected by such factors as the video card, motherboard and the network environment.

Uninstall

The MDC program can be removed only by using the "Add or Remove Programs" option of the Windows® Control Panel.

Perform the following steps remove MDC.

Select "Setting/Control Panel" on the "Start" menu and then double-click "Add/Delete a program".

Select MDC from the list and then click the "Add/Delete" button.

■ Using MDC

Adjusting the LCD Display

Input

Available Modes

- **P** PC / DVI
- **A** AV
- **C** Component
- **H** HDMI

Source List **PACH**



Use to select **PC**, **DVI** or other external input sources connected to the LCD Display.

Use to select the screen of your choice.

1. **PC**
2. **DVI**
3. **AV**
4. **Component**
5. **HDMI**

PIP **PACH**

Note

Available Modes: **PIP ON**

Note

When the **PIP** function is activated on the monitor, the touchscreen function may not work properly.

When external AV devices such as VCRs or DVDs are connected to the LCD Display , **PIP** allows you to watch video from those devices in a small window super-imposed on the PC Video signal. (**Off/On**)

Note

- If you select  ,  ,  in **Size**, **Position** and **Transparency** will not be activated.
-

PIP

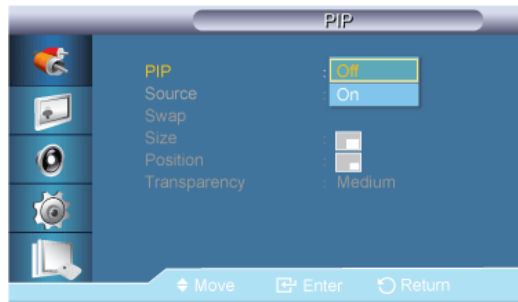

Turns the **PIP** Screen **Off/On**.

- **Off**
- **On**

Source

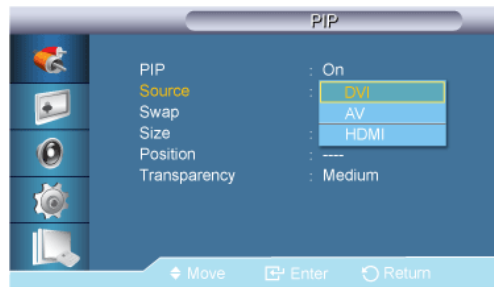

Selects the input source for the PIP.

- **PC : DVI / AV / HDMI**
DVI : PC
AV : PC
HDMI : PC

Swap

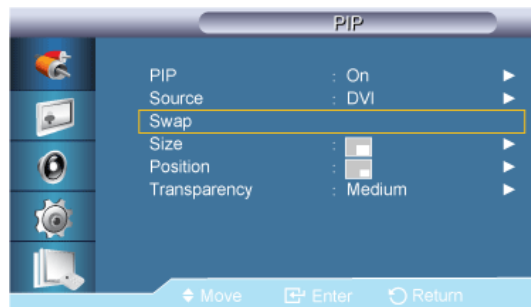

Swaps the contents of the PIP and main image.

The image in the PIP window will appear on the main screen, and the main screen image will appear in the PIP window.

Size

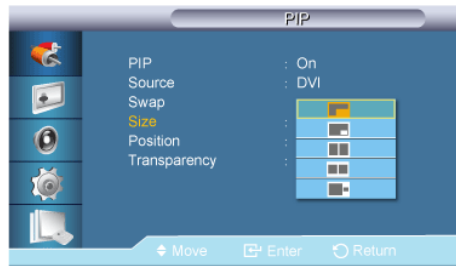

Changes the Size of the PIP window.

Position

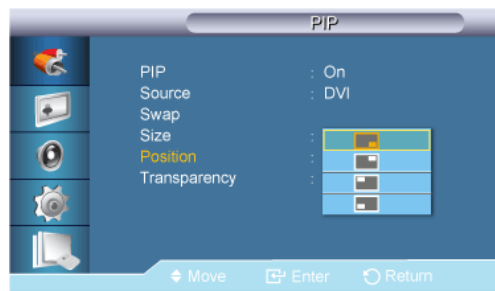

Changes the Position of the PIP window.

Transparency

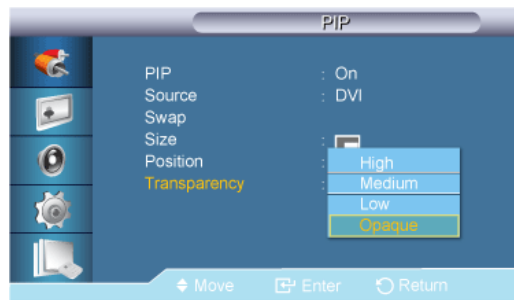

Adjusts the Transparency of PIP windows.

- **High**
- **Medium**
- **Low**
- **Opaque**

Note

- **PIP** turns off when the LCD Display is switched to an external source.
 - For **PC** and **DVI**, this is deactivated if the cable is disconnected.
-

Edit Name **PACH**



Name the input device connected to the input jacks to make your input source selection easier.

VCR / DVD / Cable STB / HD STB / Satellite STB / AV Receiver / DVD Receiver / Game / Camcorder / DVD Combo / DHR / PC / DVI Devices

Note

- The displayed devices differ depending on the external input mode.
- When connecting a PC to the HDMI or DVI terminal, set **Edit Name** to **PC**. In other cases, set **Edit Name** to **AV**. However, since 640x480, 720P (1280x720), and 1080p (1920x1080) are common signals for **AV** and **PC**, make sure to set the **Edit Name** in accordance with the input signal.
- The **Picture** menu changes depending on the input signal and **Edit Name**.

Picture [PC / DVI Mode]

Available Modes

- **P** PC / DVI
- **A** AV
- **C** Component
- **H** HDMI

MagicBright **P**



MagicBright is a feature providing the optimum viewing environment depending on the contents of the image you are watching. Currently four different modes are available: **Entertain**, **Internet**, **Text** and **Custom**. Each mode has its own pre-configured brightness value.

(Not available when **Dynamic Contrast** is set to **On**.)

1. **Entertain**
High brightness

For watching motion pictures such as from a DVD or VCR.

2. **Internet**

Medium brightness

For working with a mixture of images such as texts and graphics.

3. **Text**

Normal brightness

For documents or works involving heavy text.

4. **Custom**

Although the values are carefully chosen by our engineers, the pre-configured values may not be comfortable to your eyes depending on your taste.

If this is the case, adjust the brightness and contrast by using the OSD menu.

Custom **P**

By using the on-screen menus, the contrast and brightness can be changed to your personal preference.

(Not available when **Dynamic Contrast** is set to **On**.)



By adjusting the picture using the **Custom** function, **MagicBright** will change to **Custom** mode.

Contrast



Adjusts the Contrast.

Brightness



Adjusts the Brightness.

Sharpness



Adjusts the Sharpness.

Color Tone **P**



The color tones can be changed.

(Not available when **Dynamic Contrast** is set to **On**.)

1. **Off**
2. **Cool**
3. **Normal**
4. **Warm**
5. **Custom**



If you set the **Color Tone** to **Cool**, **Normal**, **Warm**, or **Custom**, the **Color Temp.** function is disabled.

If you set the **Color Tone** to **Off**, the **Color Control** function is disabled

Color Control **P**

Adjusts individual Red, Green, Blue color balance.

(Not available when **Dynamic Contrast** is set to **On**.)



If you adjust the picture by using the **Color Control** function, **Color Tone** will turn to the **Custom** mode.

Red



Green



Blue



Color Temp. **P**



Color Temp. is a measure of the 'warmth' of the image colors.

(Not available when **Dynamic Contrast** is set to **On**.)



This function is only enabled if the **Color Tone** is set to **Off**.

Image Lock **P**

Image Lock is used to fine-tune and get the best image by removing noise that creates unstable images with jitters and shakiness. If satisfactory results are not obtained using the Fine adjustment, use the Coarse adjustment and then use Fine again.

(Available in **PC** mode only)

Coarse



Removes noise such as vertical stripes. Coarse adjustment may move the screen image area. You may relocate it to the center using the horizontal control menu.

Fine



Removes noise such as horizontal stripes. If the noise persists even after Fine tuning, repeat it after adjusting the frequency (clock speed).

Position



Adjusts the screen location horizontally and vertically.

Auto Adjustment **P**

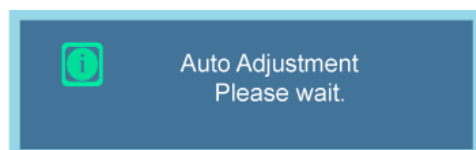

The values of **Fine**, **Coarse**, **Position** are adjusted automatically. By changing the resolution in the control panel, the auto function is performed.

(Available in **PC** mode only)

Signal Balance **P**

This is used to make up for the weak RGB signal transmitted by a long signal cable.

(Not available when **Dynamic Contrast** is set to **On**.)

(Available in **PC** mode only)

Signal Balance

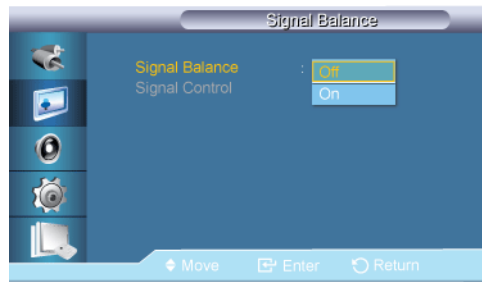

Selects either **On** or **Off** with the signal control.

Signal Control

1. **R-Gain**



2. **G-Gain**



3. **B-Gain**



4. **R-Offset**



5. **G-Offset**



6. **B-Offset**



Size **P**



The **Size** can be switched.

1. **16:9**
2. **4:3**

HDMI Black Level **P**

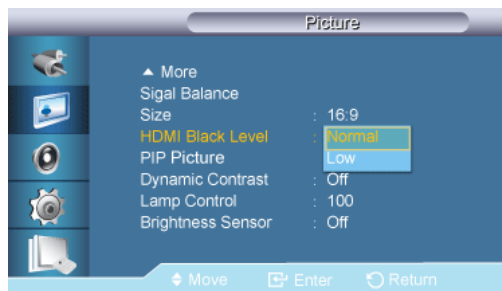

When watching with a DVD or set-top box connecting to the product via HDMI or DVI, image quality deterioration (black level, lower-quality contrast, lighter color tone, etc.) may occur depending on the connected external device.

1. **Normal**
2. **Low**

Note

- For Timing which can be used for both the PC and the DTV in **DVI**, **HDMI** mode, **HDMI Black Level** will be activated.

PIP Picture **P**

Adjusts the PIP Screen Settings.

Note

- Available Modes: **PIP ON**

1. **Contrast**



Adjusts the Contrast of the PIP window on the screen.

2. **Brightness**



Adjusts the Brightness of the PIP window on the screen.

3. **Sharpness**



Adjusts the Sharpness of the PIP window on the screen.

4. **Color**



Adjusts the Color of the PIP window on the screen.

 **Note**

Enabled only when the **PIP** input is selected in **AV**, **HDMI** or **Component** mode.

5. **Tint**



Adds a natural tone to the PIP window.

 **Note**

Enabled only when the **PIP** input is selected in **AV**, **HDMI** or **Component** mode. Operates only if the video signal is NTSC.

Dynamic Contrast 

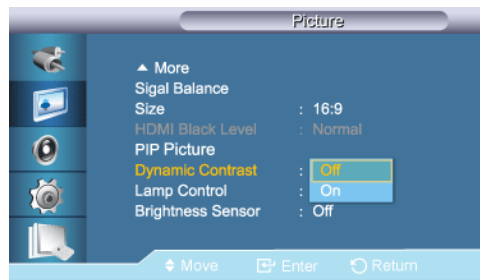

Dynamic Contrast automatically detects the distribution of the visual signal and adjusts to create an optimum contrast.

1. **Off**
2. **On**

(Disabled when **PIP** is set to **On**.)

Lamp Control 



Adjusts the inverter lamp in order to reduce energy consumption.

 **Note**

This function does not operate when **Dynamic Contrast** is set to **On** in **PC**, **DVI**, **AV**, **HDMI** or **Component** modes.

Brightness Sensor 

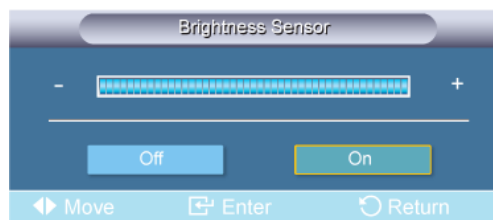

Brightness Sensor automatically detects distribution of the inputted visual signal and adjusts to create optimum brightness.

1. **Off**

2. On

Picture [AV / HDMI / Component Mode]

Available Modes

- **P** PC / DVI
- **A** AV
- **C** Component
- **H** HDMI

Mode **AHC**

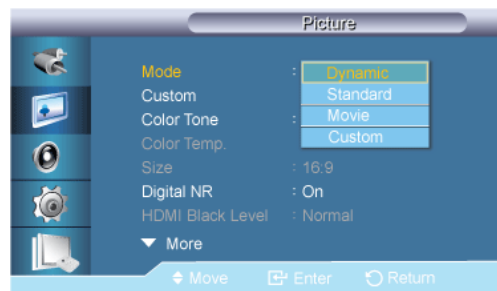

The LCD Display has four automatic picture settings ("**Dynamic**", "**Standard**", "**Movie**" and "**Custom**") that are preset at the factory.

Dynamic, **Standard**, **Movie**, or **Custom** can be activated.

(Not available when **Dynamic Contrast** is set to **On**.)

1. **Dynamic**
2. **Standard**
3. **Movie**
4. **Custom**

Custom **AHC**

By using the on-screen menus, the contrast and brightness can be changed to your personal preference.

(Not available when **Dynamic Contrast** is set to **On**.)

Contrast



Adjusts the Contrast.

Brightness



Adjusts the Brightness.

Sharpness



Adjusts the picture Sharpness.

Color



Adjusts the picture Color.

Tint



Adds a natural tone to the display.

Color Tone **AHC**



The color tones can be changed. The individual Color components are also user adjustable.

(Not available when **Dynamic Contrast** is set to **On**.)

1. **Off**
2. **Cool2**
3. **Cool1**
4. **Normal**
5. **Warm1**
6. **Warm2**

Note

If you set the **Color Tone** to **Cool2**, **Cool1**, **Normal**, **Warm1**, or **Warm2**, the **Color Temp.** function is disabled.

Color Temp. **AHC**



Color temp. is a measure of the 'warmth' of the image colors.

(Not available when **Dynamic Contrast** is set to **On**.)

 **Note**

This function is only enabled if the **Color Tone** is set to **Off**.

Size 



The **Size** can be switched.

1. **16:9**: Sets the picture to 16:9 wide mode.
2. **Zoom 1**: Magnifies the size of the picture on the screen.
3. **Zoom 2**: Magnifies the size of the picture more than **Zoom 1**.
4. **4:3**: Sets the picture to 4:3 normal mode.
5. **Screen Fit**: Displays the input scenes as they are without any cutoff when HDMI 720p, 1080i, 1080p signals are input.

(Not available when **Dynamic Contrast** is set to **On**.)

 **Note**

- Certain external devices may feed the display an out of spec signal that may cause cutoff even when using the **Screen Fit** feature.
- **Zoom 1**, **Zoom 2** are unavailable in **HDMI** mode.
- The **Position** and **Reset** functions are available in **Zoom 1** or **Zoom 2** modes.

Digital NR (Digital Noise Reduction) 

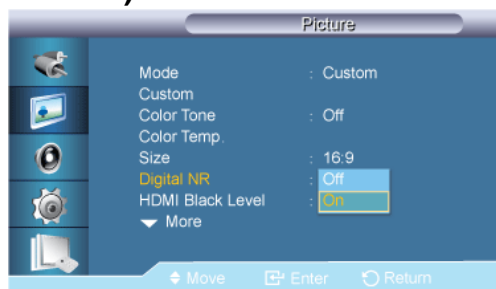

Turns the Digital Noise Reduction feature **Off/On**. The Digital Noise Reduction feature allows you to enjoy clearer and crisper images.

1. **Off**
2. **On**

 **Note**

Digital NR function is not available for all resolutions.

HDMI Black Level **A****C****H**



When a DVD or set-top box is connected to your TV via HDMI or DVI, it may cause a degradation in the screen quality, such as an increase in the black level, a low contrast, or discoloration, etc., depending on the external device connected. In this case, adjust the screen quality of your TV by configuring the **HDMI black level**.

1. **Normal**
2. **Low**



Note

For Timing which can be used for both the PC and the DTV in **DVI, HDMI** mode, **HDMI Black Level** will be activated.

Film Mode **A****C****H**



The **Film Mode** feature offers you a theater-quality viewing experience.

In **HDMI** mode, this function is available when the input signal is interlaced scan; it is not available in progressive scan.

1. **Off**
2. **On**

PIP Picture **A****C****H**

Adjusts the PIP Screen Settings.



Note

- Available Modes: **PIP ON**

1. **Contrast**



Adjusts the Contrast of the PIP window on the screen.

2. **Brightness**



Adjusts the Brightness of the PIP window on the screen.

3. **Sharpness**



Adjusts the Sharpness of the PIP window on the screen.

4. **Color**



Adjusts the Color of the PIP window on the screen.

 **Note**

This function is not available if PC signal is received while in **DVI** or **HDMI** mode.

5. **Tint**



Adds a natural tone to the PIP window.

 **Note**

This function is not available if PC signal is received while in **DVI** or **HDMI** mode. Operates only if the video signal is NTSC.

Dynamic Contrast **A H C**



Dynamic Contrast automatically detects the distribution of the visual signal and adjusts to create an optimum contrast.

1. **Off**

2. **On**

(Disabled when **PIP** is set to **On**.)

Lamp Control **A H C**



Adjusts the inverter lamp in order to reduce energy consumption.

 **Note**

This function does not operate when **Dynamic Contrast** is set to **On** in **PC**, **DVI**, **AV**, **HDMI** or **Component** modes.

Brightness Sensor **AHC**

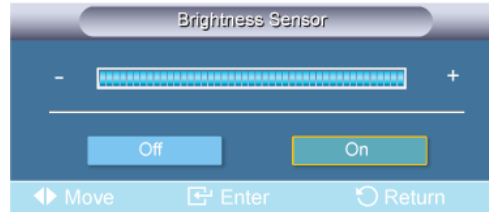

Brightness Sensor automatically detects distribution of the inputted visual signal and adjusts to create optimum brightness.

1. **Off**
2. **On**

Sound

Available Modes

- **P** PC / DVI
- **A** AV
- **G** Component
- **H** HDMI

Mode **PACH**



The LCD Display has a built-in high fidelity stereo amplifier.

1. **Standard**
Selects **Standard** for the standard factory settings.
 2. **Music**
Selects **Music** when watching music videos or concerts.
 3. **Movie**
Selects **Movie** when viewing movies.
 4. **Speech**
-

Selects **Speech** when watching a show that is mostly dialog (i.e., news).

5. **Custom**

Selects **Custom** if you want to adjust the settings according to your personal preferences.

Custom P A C H

The sound settings can be adjusted to suit your personal preferences.

 **Note**

- You can hear the sound even when sound value is set to 0.
- If you adjust sound using **Custom** function, **Mode** will turn to **Custom** mode.

Bass



Emphasizes low frequency audio.

Treble



Emphasizes high frequency audio.

Balance



Allows you to Adjusts the sound balance between the left and right speakers.

Auto Volume P A C H

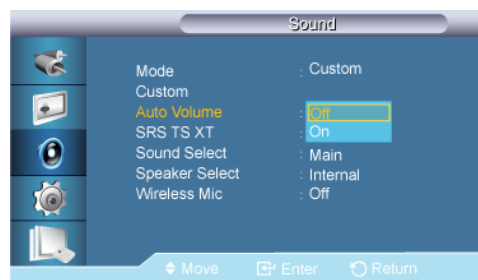

Reduces the difference in volume control between broadcasters.

1. **Off**
2. **On**

SRS TS XT PACH

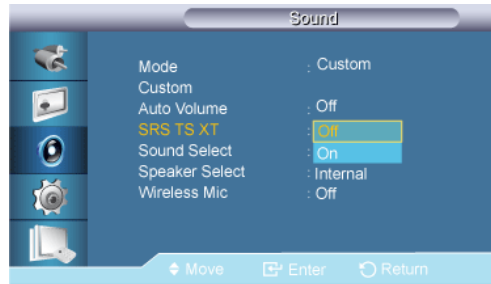

SRS TS XT is a patented SRS technology that solves the problem of playing 5.1 multichannel content over two speakers. TruSurround XT delivers a compelling, virtual surround sound experience through any two-speaker playback system, including internal television speakers. It is fully compatible with all multichannel formats.

1. **Off**
2. **On**

Sound Select PACH

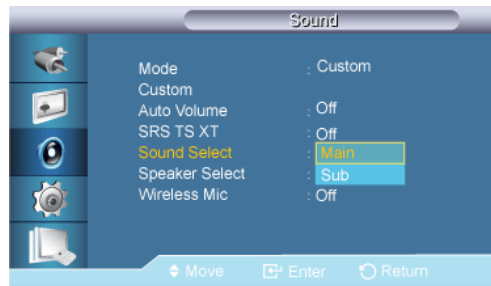

Selects either Main or Sub when **PIP** is **On**.

 **Note**

Available Modes: **PIP ON**

1. **Main**
2. **Sub**

Speaker Select PACH

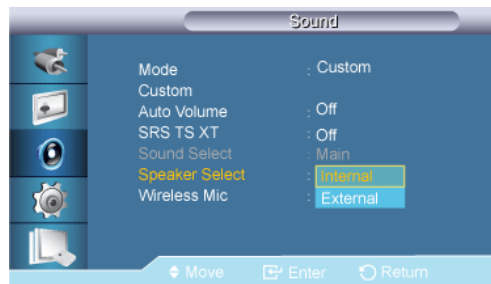

When you use the product with it connecting to a Home theater, turn the Internal speakers off so you can listen to sound from the Home theater's (external) speakers.

1. **Internal**

Sound is outputted both from the **Internal** speaker and the **External** speakers, but the volume control is only available from the **Internal** speaker.

2. External

When sound is only outputted from the **External** speakers, the volume control is also only available from the **External** speakers.

Wireless Mic **PACH**

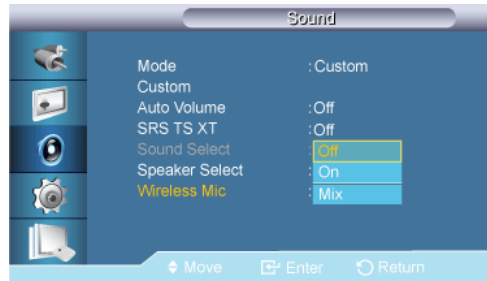

Set the **Wireless Mic** function to **On** or **Off**.

1. **Off**
2. **On**
3. **Mix**

Setup

Available Modes

- **P** PC / DVI
- **A** AV
- **C** Component
- **H** HDMI

Language **PACH**

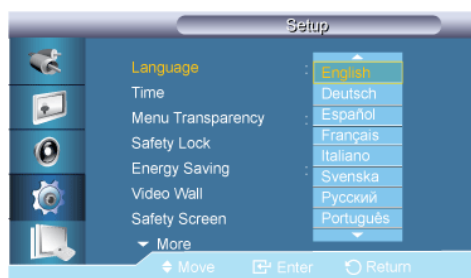

You can choose one of 13 languages.

English, Deutsch, Español, Français, Italiano, Svenska, Русский
Português, Türkçe, 简体中文, 繁體中文, 日本語, 한국어

Note

The language chosen affects only the language of the OSD. It has no effect on any software running on the computer.

Time **PACH**

Selects from one of 4 time settings, **Clock Set**, **Sleep Timer**, **On Timer**, and **Off Timer**.

Clock Set



Current Time Setting.

Sleep Timer



Turns the LCD Display off automatically at certain times.

1. **Off**
2. **30**
3. **60**
4. **90**
5. **120**
6. **150**
7. **180**

On Timer



Turns the LCD Display on automatically at a preset time. Controls the mode and the volume level at the time the LCD Display turns on automatically.

Off Timer



Turns the LCD Display off automatically at a preset time.

Menu Transparency **PACH**

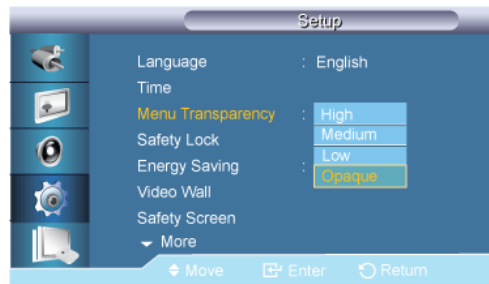

Change the transparency of the background of the OSD.

1. **High**
2. **Medium**
3. **Low**
4. **Opaque**

Safety Lock **PACH**

Change PIN



The password can be changed.

 **Note**

The preset password for the LCD Display is "0000".

Lock On

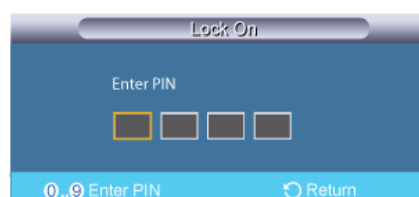

This is the function that locks the OSD in order to keep the current settings or to prevent others from adjusting the settings.

Energy Saving PACH

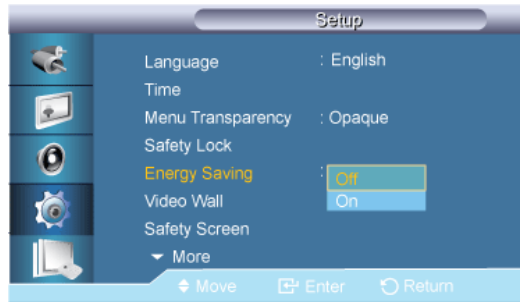

This feature adjusts the power consumption of the unit in order to save energy.

1. **Off**
2. **On**

Video Wall PACH

A **Video Wall** is a set of video screens connected together, so that each screen shows a part of the whole picture or where the same picture is repeated on each screen.

When the **Video Wall** is on, you can adjust the **Video Wall** screen setting.



When **Video Wall** is running, the **Auto Adjustment**, **Image Lock**, and **Size** functions are not available.

Video Wall

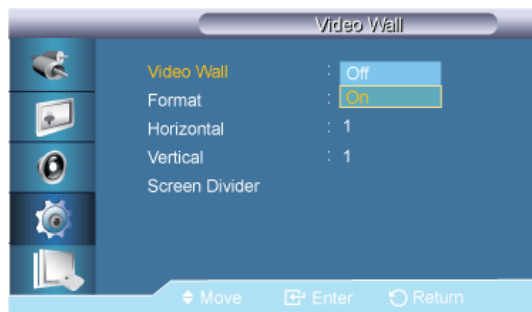

Turns Off/On the **Video Wall** function of the selected display Off/On.

1. **Off**
2. **On**

Format



The **Format** can be selected to see a divided screen.

1. **Full**

Provides a full screen without any margins.

2. **Natural**

Displays a natural image with the original aspect ratio intact.

Horizontal



Sets how many parts the screen should be divided horizontally.

Five adjustment levels: 1, 2, 3, 4, and 5.

Vertical



Sets how many parts the screen should be divided vertically.

Five adjustment levels: 1, 2, 3, 4, and 5.

Screen Divider



The screen can be divided into several images. A number of screens can be selected with a different layout when dividing.

- Select a mode in Screen Divider.
 - Select a display in Display Selection.
 - The selection will be set up by pressing a number in the selected mode.
-

Safety Screen **PACH**

The **Safety Screen** function is used to prevent afterimages that may appear when a still picture is displayed on the screen over a long time.

- The **Safety Screen** function scrolls the screen for the specified period of time.
- This function is not available when the power is turned off.

Pixel Shift

Pixel Shift

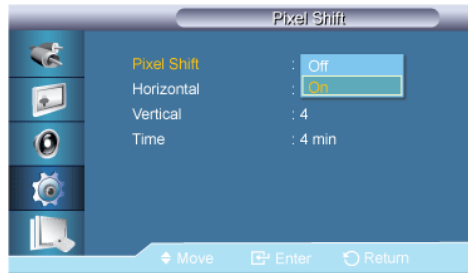

To prevent after-images on the screen, you can use this function to have pixels move on the LCD in the horizontal or vertical direction.

1. **Off**
2. **On**

Horizontal

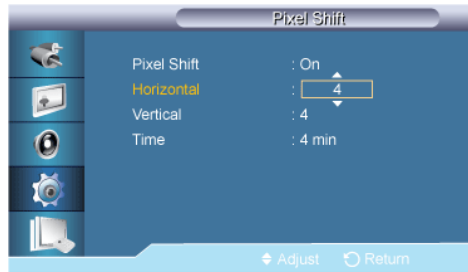

Sets how many pixels the screen moves horizontally.

Five adjustment levels: 0, 1, 2, 3, and 4.

Vertical

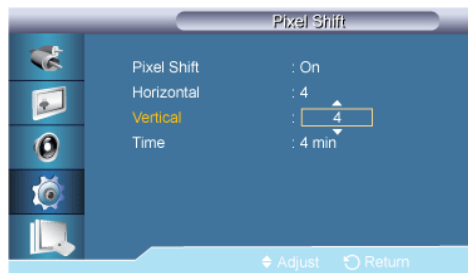

Sets how many pixels the screen moves vertically.

Five adjustment levels: 0, 1, 2, 3, and 4.

Time

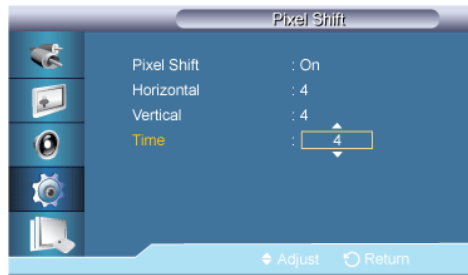

Set the time interval for performing the horizontal or vertical movement, respectively.

Timer

Timer

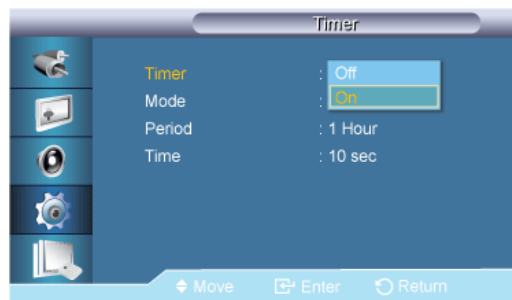

You can set the timer for Screen Burn Protection.

If you start the operation to erase any residual image, the operation will be performed for the set period of time and then automatically finish.

1. **Off**
2. **On**

Mode



You can change the **Safety Screen** Type.

1. **Scroll**
 2. **Bar**
 3. **Eraser**
-

Period



Use this function to set the execution period for each mode set in the timer.

Time



Within the set period of time specify a time for execution.

- **Mode-Scroll** : 1~5 sec
- **Mode-Bar, Eraser** : 10~50 sec

Scroll



This function helps to remove after-images on the screen by moving all the pixels on the LCD according to a pattern.

Use this function when there are remaining after-images or symbols on the screen, especially when you displayed a still image on the screen for a long time.

Bar



This function prevents after-images on the screen by moving long black and white vertical lines.

Eraser



This function prevents after-images on the screen by moving a rectangular pattern.

Side Gray



Select the brightness of the grey for the screen background.

1. **Off**
2. **Light**
3. **Dark**

Resolution Select **P**

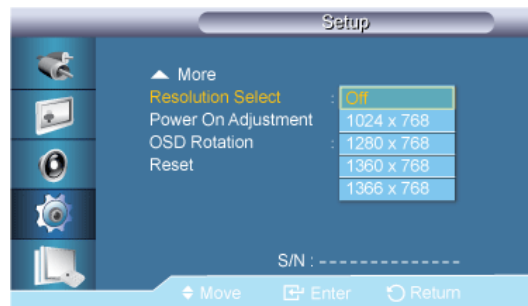

When the picture is not displayed properly on the screen when setting the graphics card resolution of the computer to 1024 x 768 @ 60Hz, 1280 x 768 @ 60Hz, 1360 x 768 @ 60Hz or 1366 x 768 @ 60Hz, by using this function(Resolution Select), you can have the picture displayed on the screen in the specified resolution.

Note

Available in **PC** mode only

1. **Off**
2. **1024 X 768**
3. **1280 X 768**
4. **1360 x 768**

5. **1366 X 768**



Selecting the menu is only allowed when the graphics resolution is set to 1024 x 768 @ 60Hz, 1280 x 768 @ 60Hz, 1360 x 768 @ 60Hz or 1366 x 768 @ 60Hz.

Power On Adjustment PACH

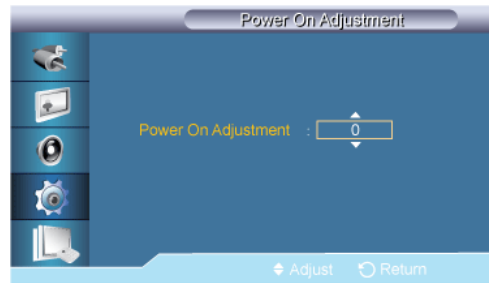

Adjusts the Power On time for the screen.



Caution: Set the Power On time to be longer to avoid overvoltage.

OSD Rotation PACH



OSD Rotate

1. **Landscape**
2. **Portrait**

Reset

Reverts the product settings to factory defaults. The Reset function is only available when **PC / DVI** is being used.

Image Reset P



Available in **PC** mode only



Note

The **Reset** function is not available when **Video Wall** is **On**.

Color Reset **PACH**

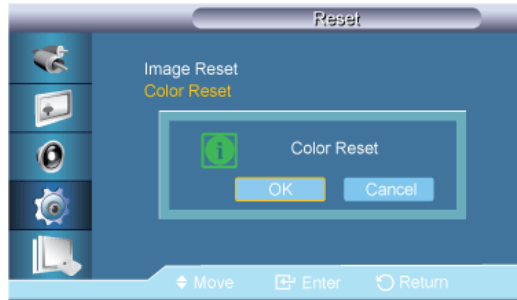

Multi Control

Available Modes

- **P** PC / DVI
- **A** AV
- **C** Component
- **H** HDMI

Multi Control **PACH**

Assigns an individual ID to the SET.

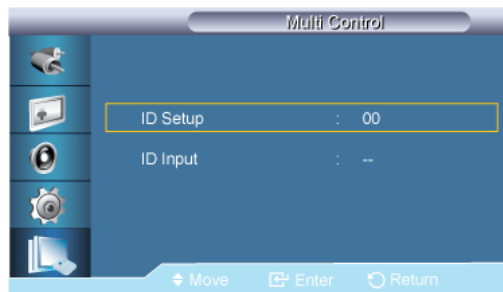

- **ID Setup**

Assigns distinctive IDs to the SET.

- **ID Input**

Use to select the transmitter functions of the individual SET. Only a SET where the ID corresponds to the transmitter setting becomes activated.

Troubleshooting

Self-Test Feature Check



Check the following items yourself before calling for assistance. Contact a Service Center for problems that you cannot solve by yourself.

Self-Test Feature Check

1. Turn off both your computer and the LCD Display.
2. Unplug the video cable from the back of the computer.
3. Turn on the LCD Display.

The figure shown below ("**Check Signal Cable**") appears on a black background when the LCD Display is working normally even though no video signal is detected: While in the Self-Test mode, the LED power indicator remains green and the figure moves around on the screen.



4. Turn off your LCD Display and reconnect the video cable; then turn on both your computer and the LCD Display

If your LCD Display screen remains blank after using the previous procedure, check your video controller and computer system; your LCD Display is functioning properly.

Warning Messages

You can even view the screen at a resolution of 1920 x 1080. However, you will receive the following message for a minute; You can choose to change the screen resolution or stay in the current mode during that time. If the resolution is more than 85Hz, you will see the black screen because the LCD Display does not support over 85Hz.

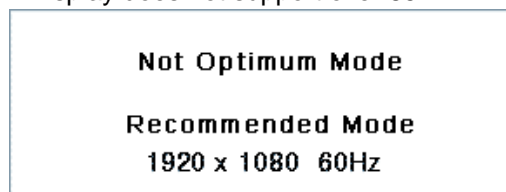

Refer to Specifications > Preset Timing Modes for the resolutions or frequencies supported by the LCD Display.

Maintenance and Cleaning

- 1) Maintaining the LCD Display Case.

Clean with a soft cloth after disconnecting the power cord.



- Do not use benzene, thinner or other flammable substances.

2) Maintaining the Flat Panel Display Screen.

Clean with a soft cloth (cotton flannel).



- Never use acetone, benzene or thinner.
(They may cause flaws or deformation of the screen surface.)
- The user is responsible for any damage caused by using these substances.

Symptoms and Recommended Actions

Note

A LCD Display recreates visual signals received from the computer. Therefore, if there is a problem with the computer or the video card, this can cause the LCD Display to become blank, have poor coloring, become noisy, etc. In this case, first check the source of the problem, and then contact a Service Center or your dealer.

1. Check if the power cord and the video cables are properly connected to the computer.
2. Check if the computer beeps more than 3 times when booting.
(If it does, request service.)
3. If you installed a new video card or if you assembled the PC, check if you installed the Adaptor(video).
4. Check if the scanning ratio of the video screen is set to between 56 Hz ~ 85 Hz.
(Do not exceed 60Hz when using the maximum resolution.)
5. If you have problems in installing the Adaptor (video) driver, boot the computer in Safe Mode, remove the Display Adaptor in the "Control Panel -> System -> Device Administrator" and then reboot the computer to reinstall the Adaptor (video) driver.

Check List

Note

- The following table lists possible problems and their solutions. Before calling for assistance, check the information in this section to see if you can remedy any problems for yourself. If you do need assistance, please call the phone number on the Information section or contact your dealer.

Problems related to the Installation (PC Mode)

Note

Problems related to the LCD Display installation and their solutions are listed.

Q: The LCD Display screen flickers.

A: Check if the signal cable between the computer and the LCD Display is securely connected.

(Refer to Connecting a Computer)

Problems related to the Screen



Note

Problems related to the LCD Display screen and their solutions are listed.

Q: The screen is blank and the power indicator is off.

A: Ensure that the power cord is firmly connected and the LCD Display is on.

(Refer to the Connecting a Computer)

Q: "**Check Signal Cable**" message.

A: Ensure that the signal cable is firmly connected to the PC or video sources.

(Refer to the Connecting a Computer)

A: Ensure that the PC or video sources are turned on.

Q: "**Not Optimum Mode**" message.

A: Check the maximum resolution and the frequency of the video Adaptor.

A: Compare these values with the data in the Preset Timing Modes Chart.

Q: The picture rolls vertically.

A: Check if the signal cable is securely connected. Re-connect it, if necessary.

(Refer to Connecting a Computer)

Q: The image is not clear; picture is blurred.

A: Run Frequency **Coarse** and **Fine** tuning.

A: Turn on again after removing all accessories (video extension cable, etc.)

A: Set the resolution and frequency to the recommended ranges.

Q: The picture image is unstable and shakes.

A: Check if the resolution and frequency set for the computer video card falls in the range supported by the LCD Display. If not, reset them referring to the current Information under the LCD Display menu and Preset Timing Modes.

Q: Ghost images are shown in the picture.

A: Check if the resolution and frequency set for the computer video card falls in the range supported by the LCD Display. If not, reset them referring to the current Information under the LCD Display menu and Preset Timing Modes.

Q: The image is too light or too dark.

A: Adjust the **brightness** and **contrast**.

(Refer to the **Brightness, Contrast**)

- Q: The screen color is inconsistent.
- A: Adjust color using **Custom** under OSD Color Adjustment menu.
- Q: The color image is distorted by dark shadows.
- A: Adjust color using **Custom** under OSD Color Adjustment menu.
- Q: The color white is poor.
- A: Adjust color using **Custom** under OSD Color Adjustment menu.
- Q: The Power Indicator blinks.
- A: The LCD Display is currently saving the changes made in the settings to the OSD memory.
- Q: The screen is blank and the power indicator light blinks every 0.5 or 1 seconds.
- A: The LCD Display is using its power management system. Press any key on the keyboard.
- Q: The screen is blank and it is blinking.
- A: If you see the "**TEST GOOD**" message on the screen when you pressing the MENU button, check the cable connection between the LCD Display and the computer to ensure that the connector is properly connected.

Problems related to stylus

- Q: My stylus pen is missing.
- A: The stylus pen can be purchased at the nearest Service Center.
- The product code is BN96-12546A.

Problems related to Audio



Problems related to audio signals and their solutions are listed below.

- Q: No sound.
- A: Ensure that the audio cable is firmly connected to both the audio-in port on your LCD Display and the audio-out port on your sound card.
- (Refer to the Connecting a Computer)
- A: Check the volume level.
- Q: The sound level is too low.
- A: Check the volume level.
- A: If the volume is still too low after turning the control to its maximum, check the volume control on the computer sound card or software program.
- Q: The sound is too high or too low.
- A: Adjusts the **Treble** and **Bass** to the appropriate levels.
-

Problems related to the Remote Control



Problems related to the remote control and their solutions are listed.

Q: The remote control buttons do not respond.

A: Check the polarities (+/-) of the batteries.

A: Check if the batteries are empty.

A: Check if the power is on.

A: Check if the power cord is securely connected.

A: Check if a special fluorescent or neon lamp is on in the vicinity.

Q & A

Q: How can I change the frequency?

A: The frequency can be changed by reconfiguring the video card.



That video card support can vary, depending on the version of the driver used. (Refer to the computer or the video card manual for details.)

Q: How can I adjust the resolution?

A: Windows XP:

Set the resolution in the Control Panel Appearance and Themes Display Settings.

A: Windows ME/2000:

Set the resolution in the Control Panel Display Settings.

* Contact the video card manufacturer for details.

Q: How can I set the Power Saving function?

A: Windows XP:

Set the resolution in the Control Panel Appearance and Themes Display Screen Saver.

Set the function in the BIOS-SETUP of the computer. (Refer to the Windows / Computer Manual).

A: Windows ME/2000:

Set the resolution at the Control Panel Display Screen Saver.

Set the function in the BIOS-SETUP of the computer. (Refer to the Windows / Computer Manual).

Q: How can I clean the outer case/LCD Panel?

A: Disconnect the power cord and then clean the LCD Display with a soft cloth, using either a cleaning solution or plain water.

Do not leave any detergent or scratches on the case. Do not let any water enter the LCD Display.

Q: How can I play the video?

A: The video supports the MPEG1 and WMV codecs only. Install the corresponding codec to play the video. Note that some of the codecs can be incompatible.



Before calling for assistance, check the information in this section to see if you can remedy any problems yourself. If you do need assistance, please call the phone number on the Information section or contact your dealer.

Specifications

General

General

Model Name	SyncMaster 650TS-2
------------	--------------------

LCD Panel

Size	65 inches (163 cm)
------	--------------------

Display area	1428.48 mm (H) x 803.52 mm (V)
--------------	--------------------------------

Pixel Pitch	0.744 mm (H) x 0.744 mm (V)
-------------	-----------------------------

Synchronization

Horizontal	30 ~ 81 kHz
------------	-------------

Vertical	56 ~ 85 Hz
----------	------------

Display Color

16.7 M

Resolution

Optimum resolution	1920 x 1080 @ 60 Hz (RB)
--------------------	--------------------------

Maximum resolution	1920 x 1080 @ 60 Hz (RB)
--------------------	--------------------------

Input Signal, Terminated

RGB Analog, DVI(Digital Visual Interface) Compliant Digital RGB

0.7 Vp-p \pm 5 %

Separate H/V sync, Composite, SOG

TTL level (V high 2.0 V, V low 0.8 V)

Maximum Pixel Clock

148.5MHz (Analog,Digital)

Power Supply

This product supports 100 - 240 V.

Since the standard voltage may differ from country to country, please check the label on the back of the product.

Signal Cable

15pin-to-15pin D-sub cable, Detachable

DVI-D to DVI-D connector, Detachable

Dimensions (W x H x D) / Weight

1554.0 x 924.0 x 138.0 mm / 61.2 x 36.4 x 5.4 inches (Without Stand)

1554.0 x 1029.0 x 500.0 mm / 61.2 x 40.5 x 19.7 inches / 69.0 Kg / 152.1 lbs (With Stand)

VESA Mounting Interface

800 x 400 mm

Environmental considerations

Operating Temperature : 32°F ~ 104°F (0°C ~ 40°C)

Humidity : 10 % ~ 80 %, non-condensing

Storage Temperature : -4°F ~ 113°F (-20°C ~ 45°C)

Humidity : 5 % ~ 95 %, non-condensing

Plug and Play Capability

This LCD Display can be installed on any Plug & Play compatible system. The interaction of the LCD Display and the computer systems will provide the best operating conditions and LCD Display settings. In most cases, the LCD Display installation will proceed automatically, unless the user wishes to select alternate settings.

Dot Acceptable

TFT-LCD panels manufactured by using advanced semiconductor technology with precision of 1ppm (one millionth) above are used for this product. But the pixels of RED, GREEN, BLUE and WHITE color appear to be bright sometimes or some black pixels may be seen. This is not from bad quality and you can use it without any problems.

For example, the number of TFT-LCD sub pixels contained in this product are 6,220,800.

Note

Design and specifications are subject to change without prior notice.

Class A (Information Communication equipment for industrial use)

- Attention dealers and users. This device is registered for EMC requirements for industrial use (Class A) and can be used in areas other than general households.

PowerSaver

This LCD Display has a built-in power management system called PowerSaver. This system saves energy by switching your LCD Display to low-power mode when it has not been used for a certain amount of time. The LCD Display automatically returns to normal operation when you press a key on the keyboard. For energy conservation, turn your LCD Display OFF when it is not needed, or when leaving it unattended for long periods. The PowerSaver system operates with a VESA DPM compliant video card installed in your computer. Use the software utility installed on your computer to set up this feature.

State	Normal Operation	Power saving mode	Power off (Power-button)	Power off (Power-switch)
Power Indicator	On	Blinking	Off	Off
Power Consumption	430 watts	Less than 2 watts	1 watts	0 watts

Preset Timing Modes

If the signal transferred from the computer is the same as the following Preset Timing Modes, the screen will be adjusted automatically. However, if the signal differs, the screen may go blank while the power LED is on. Refer to the video card manual and adjusts the screen as follows.

Display Mode	Horizontal Frequency (kHz)	Vertical Frequency (Hz)	Pixel Clock (MHz)	Sync Polarity (H/V)
IBM, 640 x 350	31.469	70.086	25.175	+/-
IBM, 640 x 480	31.469	59.940	25.175	-/-
IBM, 720 x 400	31.469	70.087	28.322	-/+
MAC, 640 x 480	35.000	66.667	30.240	-/-
MAC, 832 x 624	49.726	74.551	57.284	-/-
MAC, 1152 x 870	68.681	75.062	100.000	-/-
VESA, 640 x 480	37.861	72.809	31.500	-/-
VESA, 640 x 480	37.500	75.000	31.500	-/-
VESA, 800 x 600	35.156	56.250	36.000	+/+
VESA, 800 x 600	37.879	60.317	40.000	+/+
VESA, 800 x 600	48.077	72.188	50.000	+/+
VESA, 800 x 600	46.875	75.000	49.500	+/+
VESA, 848 x 480	31.020	60.000	33.750	+/+
VESA, 1024 x 768	48.363	60.004	65.000	-/-
VESA, 1024 x 768	56.476	70.069	75.000	-/-
VESA, 1024 x 768	60.023	75.029	78.750	+/+
VESA, 1152 x 864	67.500	75.000	108.000	+/+
VESA, 1280 x 768	47.776	59.870	79.500	-/+
VESA, 1280 x 960	60.000	60.000	108.000	+/+
VESA, 1280 x 1024	63.981	60.020	108.000	+/+
VESA, 1280 x 1024	79.976	75.025	135.000	+/+
VESA, 1360 x 768	47.712	60.015	85.500	+/+
VESA, 1366 x 768	47.712	59.790	85.500	+/+
VESA, 1920 x 1080	66.587	59.934	138.500	+/-
VESA, 1920 x 1080	67.500	60.000	148.500	+/+

Horizontal Frequency

The time to scan one line connecting the right edge to the left edge of the screen horizontally is called the Horizontal Cycle and the inverse number of the Horizontal Cycle is called the Horizontal Frequency. Unit: kHz



Vertical Frequency

Like a fluorescent lamp, the screen has to repeat the same image many times per second to display an image to the user. The frequency of this repetition is

Specifications

called the Vertical Frequency or Refresh Rate. Unit:
Hz

Information

For a Better Display

➤ Adjust the computer resolution and screen injection rate (refresh rate) on the computer as described below to enjoy the best picture quality. You can have an uneven picture quality on screen if the best picture quality is not provided for TFT-LCD.

- Resolution: 1920 x 1080
- Vertical frequency (refresh rate): 60 Hz

➤ TFT-LCD panels manufactured by using advanced semiconductor technology with a precision of 1ppm (one millionth) and above is used for this product. But the pixels of RED, GREEN, BLUE and WHITE color seem to be bright sometimes or some of black pixels could be seen. This is not from bad quality and you can use it without any problems.

- For example, the number of TFT-LCD sub pixels contained in this product are 6,220,800.

➤ When cleaning the monitor and the panel outside, please apply a small amount of water to a soft cloth. Rub softly when cleaning the LCD area. If excessive force is applied, you may stain it.

➤ If you are not satisfied with the picture quality, you can get better quality of picture by performing the "**Auto Adjustment**" function in display screen that is appeared as window termination button is pressed. If there's still noise after the automatic adjustment, use the **Fine/Coarse** adjustment function.

➤ When viewing a fixed screen for an extended period of time, a residual image or blurriness may appear. Change the mode to energy save or set a screensaver to move the picture when you need to be away from the monitor for an extended period of time.

PRODUCT INFORMATION (Image Retention Free)

➤ *What is Image Retention ?*

Image retention may not occur when a LCD panel is operated under normal conditions.

Normal conditions are defined as continuously changing video patterns. When the LCD panel is operated for a long time with a fixed pattern (over 12 hours), there may be slight difference in voltage between electrodes that work the liquid crystal (LC) in a pixel. The voltage difference between electrodes increases with time, forcing the liquid crystal to lean. When this occurs, the previous image may be seen when the pattern is changed. To prevent this, the accumulated voltage difference must be decreased.

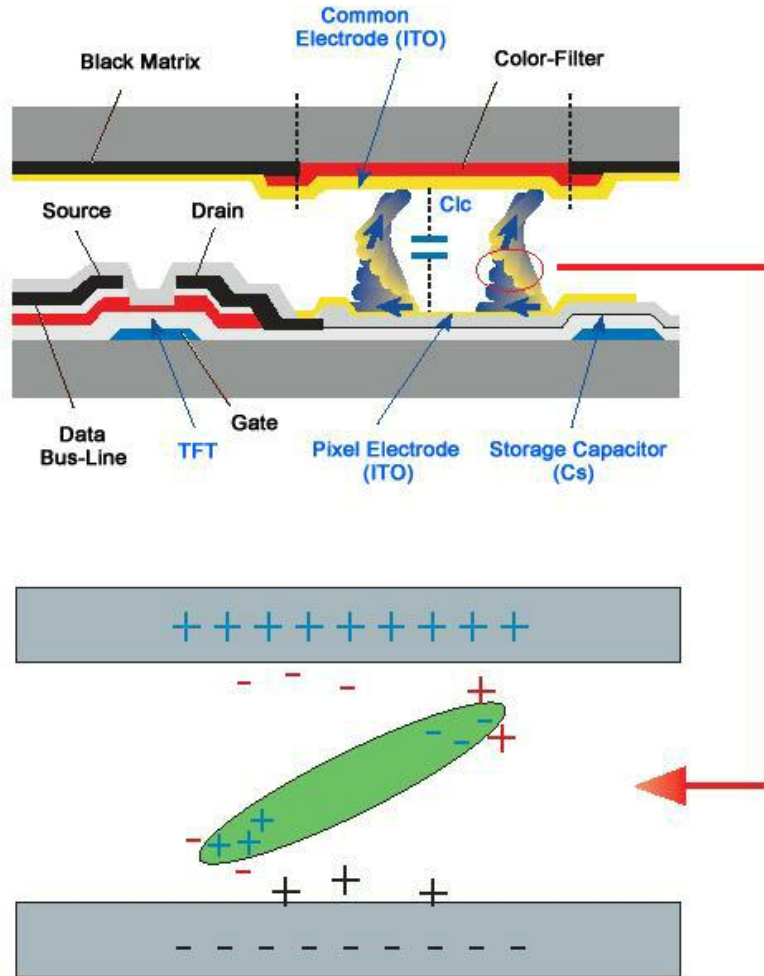

+ *Power Off, Screen Saver, or Power Save Mode*

- Turn the power off for 4 hours after 20 hours in use
- Turn the power off for 2 hours after 12 hours in use
- Set the Monitor to power off with the PC Display Properties Power Scheme.
- Use a Screen saver if possible - Screen saver in one color or a moving image is recommended.

+ *Change the Color Information periodically*

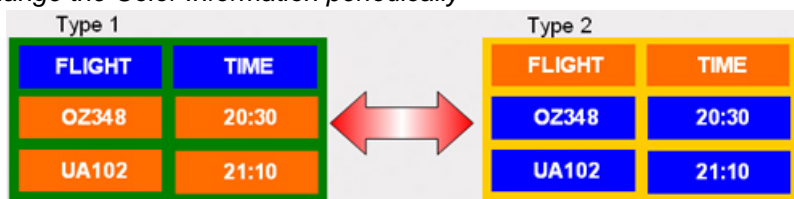

Note

Use Two different colors

Rotate the Color Information with 2 different colors every 30 minutes.

- Avoid using a combination of characters and background color with large difference in luminance.

Avoid using Grey colors, which can cause Image retention easily.

Avoid: Colors with big difference in luminance (Black & White, Grey)



➤ *Change the characters color periodically*

- Use Bright colors with little difference in luminance.
 - Cycle : Change the characters color and background color every 30 minutes



- Every 30 minutes, change the characters with movement.



- Have the images and logo cycle periodically.
 - Cycle: Display moving image together with Logo for 60 seconds after 4 hours in use.
- The best way to protect your monitor from Image retention is to turn the Power off, or set your PC or System to operate a Screen Saver program when you are not using it. If these guidelines are not followed, it may affect your warranty.

➤ *Apply the Screen Scroll function on Product*

- Apply the Screen Scroll function
 - Symptom: Horizontal Bar with Black Color move up and down.

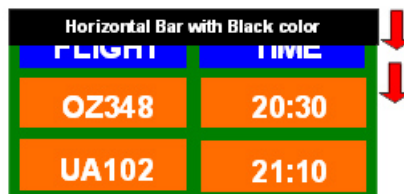

➤ *Apply the Screen Pixel function on Product*

- Apply the Screen Pixel function
 - Symptom: Dot with Black Color move up and down.

FLIGHT	TIME
OZ348	20:30
UA102	21:10

- Apply the Screen Bar function
 - Symptom: Horizontal / Vertical Bar with Black Color move up and down.

FLIGHT	TIME
OZ348	20:30
UA102	21:10

+ Apply the Screen Erasing function on Product

- Apply the Screen Erasing function
 - Symptom: 2 Vertical blocks move while erasing the display

FLIGHT	TIME
OZ348	20:30
UA102	21:10

Appendix

Contact SAMSUNG WORLDWIDE



If you have any questions or comments relating to Samsung products, please contact the SAMSUNG customer care center.

North America

U.S.A	1-800-SAMSUNG (726-7864)	http://www.samsung.com
CANADA	1-800-SAMSUNG (726-7864)	http://www.samsung.com
MEXICO	01-800-SAMSUNG (726-7864)	http://www.samsung.com

Latin America

ARGENTINA	0800-333-3733	http://www.samsung.com
BRAZIL	0800-124-421	http://www.samsung.com
	4004-0000	
CHILE	800-SAMSUNG (726-7864)	http://www.samsung.com
COLOMBIA	01-8000112112	http://www.samsung.com
COSTA RICA	0-800-507-7267	http://www.samsung.com
DOMINICA	1-800-751-2676	http://www.samsung.com
ECUADOR	1-800-10-7267	http://www.samsung.com
EL SALVADOR	800-6225	http://www.samsung.com
GUATEMALA	1-800-299-0013	http://www.samsung.com
HONDURAS	800-27919267	http://www.samsung.com
JAMAICA	1-800-234-7267	http://www.samsung.com
NICARAGUA	00-1800-5077267	http://www.samsung.com
PANAMA	800-7267	http://www.samsung.com
PERU	0-800-777-08	http://www.samsung.com
PUERTO RICO	1-800-682-3180	http://www.samsung.com
TRINIDAD & TOBAGO	1-800-SAMSUNG (726-7864)	http://www.samsung.com
VENEZUELA	0-800-100-5303	http://www.samsung.com

Europe

ALBANIA	42 27 5755	-
AUSTRIA	0810 - SAMSUNG (7267864, € 0.07/min)	http://www.samsung.com
BELGIUM	02-201-24-18	http://www.samsung.com/be (Dutch) http://www.samsung.com/be_fr (French)
BOSNIA	05 133 1999	-
BULGARIA	07001 33 11	http://www.samsung.com

Europe

CROATIA	062 SAMSUNG (062 726 7864)	http://www.samsung.com
CZECH	800 - SAMSUNG (800-726786)	http://www.samsung.com
Samsung Zrt., česká organizační složka, Oasis Florenc, Sokolovská394/17, 180 00, Praha 8		
DENMARK	70 70 19 70	http://www.samsung.com
FINLAND	030 - 6227 515	http://www.samsung.com
FRANCE	01 48 63 00 00	http://www.samsung.com
GERMANY	01805 - SAMSUNG (726-7864, €0,14/Min)	http://www.samsung.com
GREECE	2106293100	http://www.samsung.com
HUNGARY	06-80-SAMSUNG (726-7864)	http://www.samsung.com
ITALIA	800-SAMSUNG (726-7864)	http://www.samsung.com
KOSOVO	+381 0113216899	-
LUXEMBURG	261 03 710	http://www.samsung.com
MACEDONIA	023 207 777	-
MONTENEGRO	020 405 888	-
NETHERLANDS	0900-SAMSUNG (0900-7267864) (€0,10/Min)	http://www.samsung.com
NORWAY	815-56 480	http://www.samsung.com
POLAND	0 801 1SAMSUNG (172678)	http://www.samsung.com
	022-607-93-33	
PORTUGAL	80820 - SAMSUNG (7267864)	http://www.samsung.com
RUMANIA	08010 SAMSUNG (08010 7267864) – doar din rețeaua Romtelecom, tarif local: 021.206.01.10 – din orice rețea, tarif normal	http://www.samsung.com
SERBIA	0700 SAMSUNG (0700 726 7864)	http://www.samsung.com
SLOVAKIA	0800 - SAMSUNG (0800-726 786)	http://www.samsung.com/sk
SPAIN	902 - 1 - SAMSUNG (902 172 678)	http://www.samsung.com
SWEDEN	0771 726 7864 (SAMSUNG)	http://www.samsung.com
SWITZERLAND	0848 - SAMSUNG (7267864, CHF 0.08/min)	http://www.samsung.com/ch http://www.samsung.com/ch_fr/ (French)
U.K	0330 SAMSUNG (7267864)	http://www.samsung.com
EIRE	0818 717100	http://www.samsung.com
LITHUANIA	8-800-77777	http://www.samsung.com
LATVIA	8000-7267	http://www.samsung.com
ESTONIA	800-7267	http://www.samsung.com
TURKEY	444 77 11	http://www.samsung.com

Appendix

CIS

RUSSIA	8-800-555-55-55	http://www.samsung.com
GEORGIA	8-800-555-555	-
ARMENIA	0-800-05-555	-
AZERBAIJAN	088-55-55-555	-
KAZAKHSTAN	8-10-800-500-55-500 (GSM: 7799)	http://www.samsung.com
UZBEKISTAN	8-10-800-500-55-500	http://www.samsung.com
KYRGYZSTAN	00-800-500-55-500	http://www.samsung.com
TADJIKISTAN	8-10-800-500-55-500	http://www.samsung.com
UKRAINE	0-800-502-000	http://www.samsung.com/ua
		http://www.samsung.com/ua_ru
BELARUS	810-800-500-55-500	-
MOLDOVA	00-800-500-55-500	-

Asia Pacific

AUSTRALIA	1300 362 603	http://www.samsung.com
NEW ZEALAND	0800 SAMSUNG (0800 726 786)	http://www.samsung.com
CHINA	400-810-5858	http://www.samsung.com
HONG KONG	(852) 3698 - 4698	http://www.samsung.com/hk
		http://www.samsung.com/hk_en/
INDIA	3030 8282	http://www.samsung.com
	1800 3000 8282	
INDONESIA	0800-112-8888	http://www.samsung.com
	021-5699-7777	
JAPAN	0120-327-527	http://www.samsung.com
MALAYSIA	1800-88-9999	http://www.samsung.com
PHILIPPINES	1-800-10-SAMSUNG (726-7864)	http://www.samsung.com
	1-800-3-SAMSUNG (726-7864)	
	1-800-8-SAMSUNG (726-7864)	
	02-5805777	
SINGAPORE	1800-SAMSUNG (726-7864)	http://www.samsung.com
THAILAND	1800-29-3232	http://www.samsung.com
	02-689-3232	
TAIWAN	0800-329-999	http://www.samsung.com
VIETNAM	1 800 588 889	http://www.samsung.com

Middle East

IRAN	021-8255	http://www.samsung.com http://www.samservice.com
OMAN	800-SAMSUNG (726-7864)	http://www.samsung.com
KUWAIT	183-2255	http://www.samsung.com
BAHRAIN	8000-4726	http://www.samsung.com
EGYPT	08000-726786	http://www.samsung.com
JORDAN	800-22273	http://www.samsung.com
MOROCCO	080 100 2255	http://www.samsung.com
SAUDI ARABIA	9200-21230	http://www.samsung.com
U.A.E	800-SAMSUNG (726-7864)	http://www.samsung.com

Africa

NIGERIA	0800-SAMSUNG (726-7864)	http://www.samsung.com
SOUTH AFRICA	0860-SAMSUNG (726-7864)	http://www.samsung.com

Terms

Dot Pitch	The image on a monitor is composed of red, green and blue dots. The closer the dots, the higher the resolution. The distance between two dots of the same color is called the 'Dot Pitch'. Unit: mm
Vertical Frequency	The screen must be redrawn several times per second in order to create and display an image for the user. The frequency of this repetition per second is called the Vertical Frequency or Refresh Rate. Unit: Hz Example: If the same light repeats itself 60 times per second, this is regarded as 60 Hz.
Horizontal Frequency	The time to scan one line connecting the right edge to the left edge of the screen horizontally is called the Horizontal Cycle. The inverse number of the Horizontal Cycle is called Horizontal Frequency. Unit: kHz
Interlace and Non-Interlace Methods	Showing the horizontal lines of the screen from the top to the bottom sequentially is called the Non-Interlace method while showing odd lines and then even lines in turn is called the Interlace method. The Non-Interlace method is used for the majority of monitors to ensure a clear image. The Interlace method is the same as that used in TVs.
Plug & Play	This is a function that provides the best quality screen for the user by allowing the computer and the monitor to exchange information automatically. This monitor follows the international standard VESA DDC for the Plug & Play function.
Resolution	The number of horizontal and vertical dots used to compose the screen image is called the 'resolution'. This number shows the accuracy of the display. A high resolution is good for performing multiple tasks as more image information can be shown on the screen.

Example: If the resolution is 1920 x 1080, this means the screen is composed of 1920 horizontal dots (horizontal resolution) and 1080 vertical lines (vertical resolution).

Correct Disposal

Correct Disposal of This Product (Waste Electrical & Electronic Equipment) - Europe only



(Applicable in the European Union and other European countries with separate collection systems)



This marking on the product, accessories or literature indicates that the product and its electronic accessories (e.g. charger, headset, USB cable) should not be disposed of with other household waste at the end of their working life. To prevent possible harm to the environment or human health from uncontrolled waste disposal, please separate these items from other types of waste and recycle them responsibly to promote the sustainable reuse of material resources.

Household users should contact either the retailer where they purchased this product, or their local government office, for details of where and how they can take these items for environmentally safe recycling.

Business users should contact their supplier and check the terms and conditions of the purchase contract. This product and its electronic accessories should not be mixed with other commercial wastes for disposal.

Correct disposal of batteries in this product - Europe only



(Applicable in the European Union and other European countries with separate battery return systems.)

This marking on the battery, manual or packaging indicates that the batteries in this product should not be disposed of with other household waste at the end of their working life. Where marked, the chemical symbols Hg, Cd or Pb indicate that the battery contains mercury, cadmium or lead above the reference levels in EC Directive 2006/66. If batteries are not properly disposed of, these substances can cause harm to human health or the environment.

To protect natural resources and to promote material reuse, please separate batteries from other types of waste and recycle them through your local, free battery return system.



The rechargeable battery incorporated in this product is not user replaceable. For information on its replacement, please contact your service provider.

Authority

Information in this document is subject to change without notice.

© 2011 Samsung Electronics Co., Ltd. All rights reserved.

Reproduction in any manner whatsoever without the written permission of Samsung Electronics Co., Ltd. is strictly forbidden.

Samsung Electronics Co., Ltd. shall not be liable for errors contained herein or for incidental or consequential damages in connection with the furnishing, performance, or use of this material.

Samsung is the registered trademark of Samsung Electronics Co., Ltd.; Microsoft, Windows and Windows NT are registered trademarks of Microsoft Corporation; VESA, DPM and DDC are registered trademarks of Video Electronics Standard Association; All other product names mentioned herein may be the trademarks or registered trademarks of their respective owners.



TruSurround XT, SRS and the  symbol are trademarks of SRS Labs, Inc.

TruSurround XT technology is incorporated under license from SRS Labs, Inc.

CALIFORNIA USA ONLY (Applicable for networking models only.)

This Perchlorate warning applies only to primary CR(Manganese Dioxide) Lithium coin cells in the product sold or distributed ONLY in California USA

*Perchlorate Material - special handling may apply,
See www.dtsc.ca.gov/hazardouswaste/perchlorate.*