



User Guide

© Copyright 2018, 2019 HP Development Company, L.P.

Chrome, Chromebox, Google, the Google logo, and Google Cloud Print are trademarks or registered trademarks of Google LLC. microSD and the microSD logo are trademarks or registered trademarks of SD-3C in the United States, other countries or both. DisplayPort™ and the DisplayPort™ logo are trademarks owned by the Video Electronics Standards Association (VESA®) in the United States and other countries.

The information contained herein is subject to change without notice. The only warranties for HP products and services are set forth in the express warranty statements accompanying such products and services. Nothing herein should be construed as constituting an additional warranty. HP shall not be liable for technical or editorial errors or omissions contained herein.

Second Edition: October 2019

First Edition: April 2018

Document Part Number: L19841-002

Product notice

This guide describes features that are common to most models. Some features may not be available on your computer.

Software terms

By installing, copying, downloading, or otherwise using any software product preinstalled on this computer, you agree to be bound by the terms of the HP End User License Agreement (EULA). If you do not accept these license terms, your sole remedy is to return the entire unused product (hardware and software) within 14 days for a full refund subject to the refund policy of your seller.

For any further information or to request a full refund of the price of the computer, please contact your seller.

Safety warning notice

 **WARNING!** To reduce the possibility of heat-related injuries or of overheating the computer, do not place the computer directly on your lap or obstruct the computer air vents. Use the computer only on a hard, flat surface. Do not allow another hard surface, such as an adjoining optional printer, or a soft surface, such as pillows or rugs or clothing, to block airflow. Also, do not allow the AC adapter to come into contact with the skin or a soft surface, such as pillows or rugs or clothing, during operation. The computer and the AC adapter comply with the user-accessible surface temperature limits defined by applicable safety standards.

Table of contents

1 Getting to know your Chromebox	1
Right side	1
Front	2
Rear	4
Bottom	5
Labels	6
2 Using an optional keyboard and mouse	8
Using the action keys	8
3 Using your Chromebox	9
Using audio	9
Connecting speakers	9
Connecting headphones	9
Using video	9
Connecting an HDMI device	9
Connecting to your wireless network	10
Enabling and disabling Wake on LAN (WOL) function	10
Managing apps	11
4 Securing your Chromebox and information	12
Securing your wireless network	12
Backing up your software applications and information	12
Recovering your Chromebox	12
Using an optional security cable	13
5 Printing	14
Printing from Google Chrome	14
Printing with Google Cloud Print Web printing service	14
6 More HP resources	15
More HP resources	15
7 Electrostatic discharge	16

8 Accessibility	17
HP and accessibility	17
Finding the technology tools you need	17
The HP commitment	17
International Association of Accessibility Professionals (IAAP)	17
Finding the best assistive technology	18
Assessing your needs	18
Accessibility for HP products	18
Standards and legislation	19
Standards	19
Mandate 376 – EN 301 549	19
Web Content Accessibility Guidelines (WCAG)	19
Legislation and regulations	19
Useful accessibility resources and links	20
Organizations	20
Educational institutions	20
Other disability resources	20
HP links	21
Contacting support	21
Index	22

1 Getting to know your Chromebox

Right side

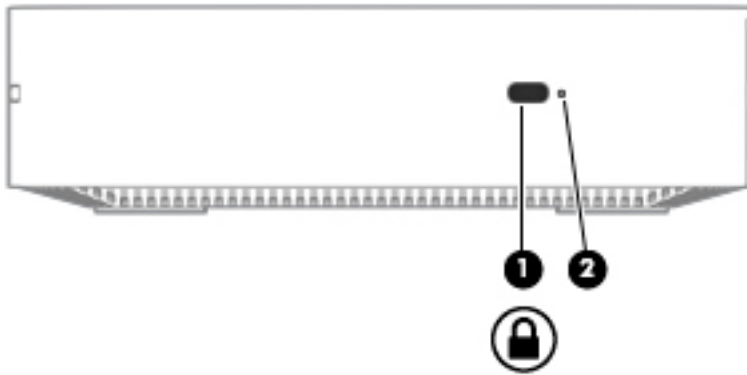



Table 1-1 Right-side components and their descriptions

Component	Description
(1)  Security cable slot	Attaches an optional security cable to the computer. NOTE: The security cable is designed to act as a deterrent, but it may not prevent the computer from being mishandled or stolen.
(2) Reset/recovery button	To to reset or recover the device, insert a paper clip (or pushpin) into the reset/recovery button hole, and then press the button. NOTE: Pressing this button with the power button deletes all account information and data stored on your Chromebox™ device, such as photos, downloaded files, and saved networks. HP recommends that you save files to an external hard drive, USB flash drive, or cloud storage for this reason. You can save your files to the cloud at any time by selecting the Google Drive™ location as your file save location. For details on how to recover your Chrome™ operating system, please see Securing your Chromebox and information on page 12 and https://support.google.com/chrome/a/answer/1360642?hl=en .

Front

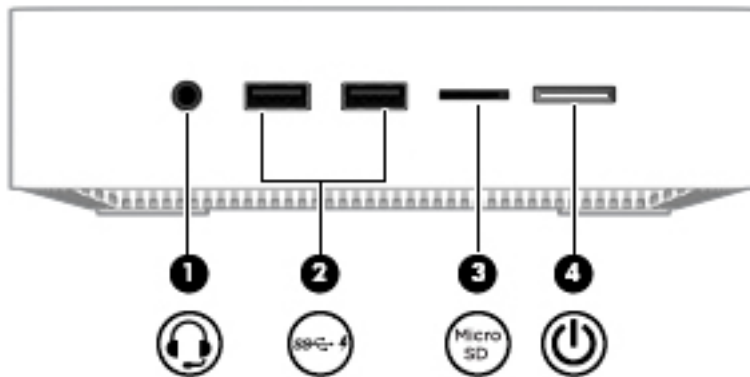

Table 1-2 Front components and their descriptions



Component	Description
<p>(1)  Audio-out (headphone)/Audio-in (microphone) combo jack</p>	<p>Connects optional powered stereo speakers, headphones, earbuds, a headset, or a television audio cable. Also connects an optional headset microphone. This jack does not support optional microphone-only devices.</p> <p>WARNING! To reduce the risk of personal injury, adjust the volume before putting on headphones, earbuds, or a headset. For additional safety information, see the <i>Regulatory, Safety, and Environmental Notices</i>.</p> <p>This guide is provided in the box.</p> <p>NOTE: When a device is connected to the jack, the computer speakers are disabled.</p>
<p>(2) USB SuperSpeed ports with HP Sleep and Charge (2)</p>	<p>Connects a USB device, provides high-speed data transfer, and even when the computer is off, charges most products such as a cell phone, camera, activity tracker, or smartwatch.</p>
<p>(3)  microSD™ memory card reader</p>	<p>Reads optional memory cards that store, manage, share, or access information.</p> <p>To insert a card:</p> <ol style="list-style-type: none"> 1. Hold the card label-side up, with connectors facing the computer. 2. Insert the card into the memory card reader, and then press in on the card until it is firmly seated. <p>To remove a card:</p> <ul style="list-style-type: none"> ▲ Pull out the card.
<p>(4) Power button/Power light</p>	<ul style="list-style-type: none"> • When the Chromebox is off, press the button to turn on the device. A white light indicates that the unit is on. The light will be off if the unit is off or in standby mode. • When the device is in the Sleep state, press the button briefly to exit Sleep. • When the device is on and you want to lock the screen, press the power button until you see the sign-in screen appear. Pressing the power button during screen-lock mode turns off the device.

Table 1-2 Front components and their descriptions (continued)

Component	Description
	<ul style="list-style-type: none">• When the device is on and you want to turn it off, press and hold the power button.

Rear

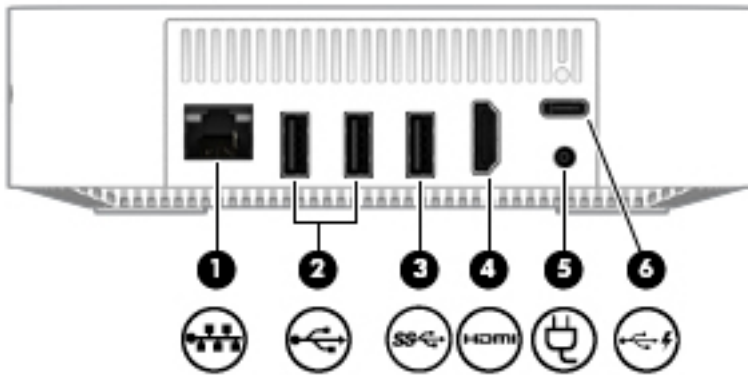







Table 1-3 Rear components and their descriptions

Component	Description
(1) 	RJ-45 (network) jack Connects a network cable.
(2) 	USB port Connects a USB device, such as a cell phone, camera, activity tracker, or smartwatch, and provides data transfer.
(3) 	USB SuperSpeed ports (2) Connect a USB device, such as a cell phone, camera, activity tracker, or smartwatch, and provides high-speed data transfer.
(4) 	HDMI port Connects an optional video or audio device, such as a high-definition television, or any compatible digital or audio device.
(5) 	Power connector Connects an AC adapter. NOTE: Your device will attempt to preserve your work in the event of a power event. If you experience a power outage or accidentally unplug your device, your Chromebox will automatically restart when power is restored.
(6) 	USB Type-C port with HP Sleep and Charge Connects a USB device that has a Type-C connector, provides data transfer, and even when the computer is off, charges most products such as a cell phone, camera, activity tracker, or smartwatch. – and – Connects a display device that has a USB Type-C connector, providing DisplayPort output. NOTE: Cables and/or adapters (purchased separately) may be required.

Bottom



Table 1-4 Bottom components and their descriptions

Component	Description
Vent	Enables airflow to cool internal components. NOTE: The device fan starts up automatically to cool internal components and prevent overheating. It is normal for the internal fan to cycle on and off during routine operation.

Labels

The labels affixed to the computer provide information you may need when you troubleshoot system problems or travel internationally with the computer.

 **IMPORTANT:** All labels described in this section will be affixed to the bottom of the computer.

- Service label—Provides important information to identify your computer. When contacting support, you will probably be asked for the serial number, and possibly for the product number or the model number. Locate these numbers before you contact support.

Your service label will resemble one of the examples shown below. Refer to the illustration that most closely matches the service label on your computer.

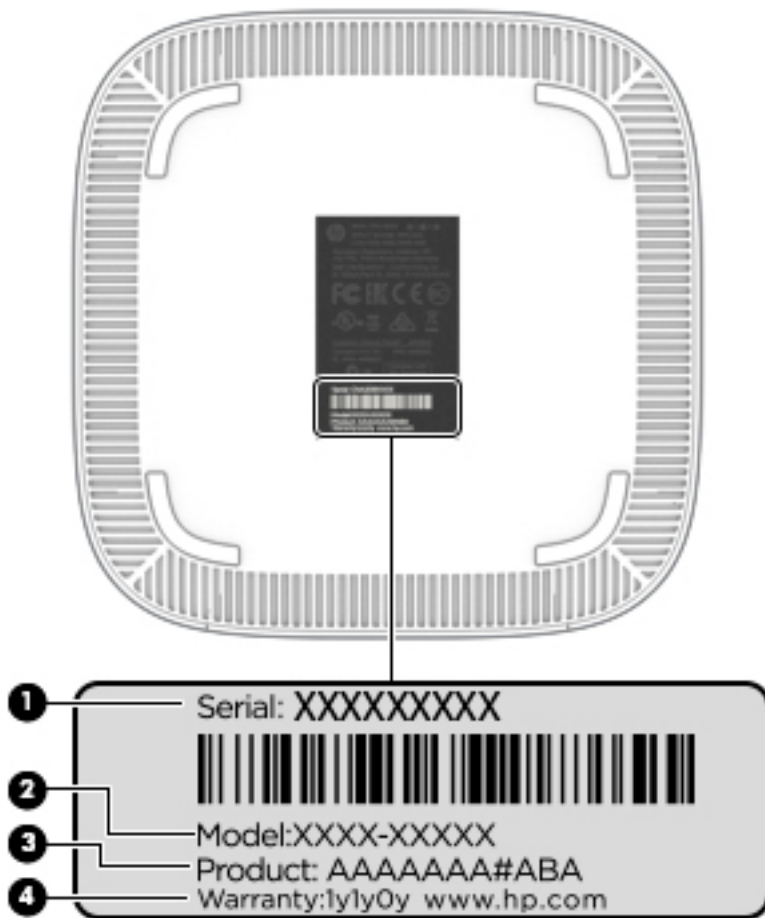

Table 1-5 Service label components

Component	
(1)	Serial number
(2)	Model number (select products only)

Table 1-5 Service label components (continued)

Component	
(3)	Product number
(4)	Warranty period

- Regulatory label(s)—Provide(s) regulatory information about the computer.
- Wireless certification label(s)—Provide(s) information about optional wireless devices and the approval markings for the countries or regions in which the devices have been approved for use.

2 Using an optional keyboard and mouse











Connecting an optional external keyboard and mouse allows you to type, select items, scroll and to perform other functions. The keyboard also allows you to use action keys and hot keys to perform specific functions.

 **TIP:** HP recommends using a Chrome-compatible keyboard with your device. Keyboards not compatible with Chrome may not offer the same action key functionality. To find a Chrome-compatible keyboard, go to www.hp.com.

Using the action keys

For more information on action keys and keyboard shortcuts, go to <https://support.google.com/chromebook/answer/183101>. Select your language at the bottom of the page.

Table 2-1 Action keys and their descriptions

Icon	Key	Description
	<code>esc</code>	Activates certain computer functions when pressed in combination with other keys, such as tab or shift.
	Back	Displays the previous page in your browser history.
	Forward	Displays the next page in your browser history.
	Reload	Reloads your current page.
	Full screen	Opens your page in full-screen mode.
	Display apps	Displays open apps. NOTE: Pressing this button in conjunction with <code>ctrl</code> takes a screenshot.
	Brightness down	Decreases the screen brightness incrementally as long as you hold down the key.
	Brightness up	Increases the screen brightness incrementally as long as you hold down the key.
	Mute	Mutes or restores speaker sound.
	Volume down	Decreases speaker volume incrementally as long as you hold down the key.
	Volume up	Increases speaker volume incrementally as long as you hold down the key.

3 Using your Chromebox

Use your HP device as an entertainment hub to enjoy and manage your music, and download and watch movies. Or, to make your device an even more powerful entertainment center, connect external devices like a monitor, projector, TV, speakers, and headphones.

Using audio

On your device, you can download and listen to music, stream audio content from the web (including radio), record audio, or mix audio and video to create multimedia. To enhance your listening enjoyment, attach external audio devices such as speakers or headphones.

Connecting speakers

You can attach wired speakers to your device by connecting them to a USB port or to the audio-out (headphone) jack on your device.

To connect *wireless* speakers to your device, follow the device manufacturer's instructions. To connect high-definition speakers to the device, see [Connecting an HDMI device on page 9](#). Before connecting speakers, lower the volume setting.

Connecting headphones

You can connect wired headphones to the headphone jack on your device.

To connect *wireless* headphones to your device, follow the device manufacturer's instructions.

 **WARNING!** To reduce the risk of personal injury, lower the volume setting before putting on headphones, earbuds, or a headset. For additional safety information, see the *Regulatory, Safety, and Environmental Notices*.

Using video

Your Chromebox is a powerful video device that enables you to watch streaming video from your favorite websites and download video and movies to watch later without needing to connect to a network.

To use one of the video ports on the device to connect an external monitor, projector, or TV. Your device has both a high-definition multimedia interface (HDMI) port, which allows you to connect a high-definition monitor or TV, and a DisplayPort™ interface, for connecting a DisplayPort-compatible device.

 **IMPORTANT:** Be sure that the external device is connected to the correct port on the Chromebox with the correct cable. Check the device manufacturer's instructions.

Connecting an HDMI device

 **NOTE:** To connect an HDMI device to your Chromebox, you need an HDMI cable, sold separately.

To see the video image on a high-definition TV or monitor, connect the high-definition device according to the following instructions:

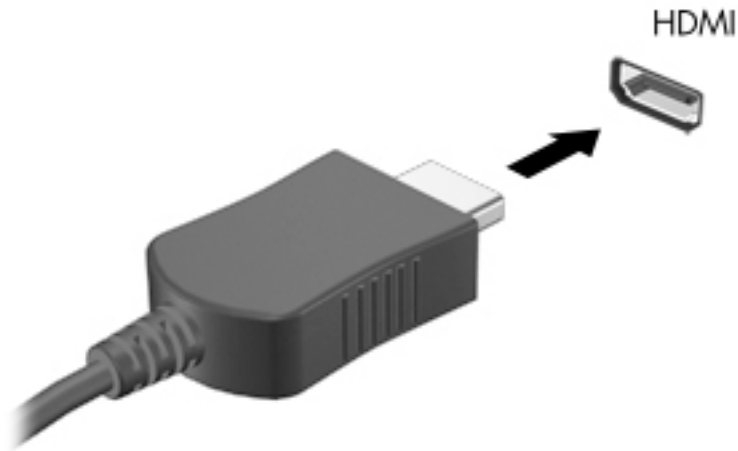

1. Connect one end of the HDMI cable to the HDMI port on the Chromebox.



2. Connect the other end of the cable to the high-definition TV or monitor.
3. You now see the Chrome desktop on your display device.

Connecting to your wireless network

To connect to a wireless network, use the following steps.

1. From the Chrome desktop, click the **Chrome menu** and then select **Wireless networks available**, or select the wireless icon  in the status area on the lower-right side of the screen.
2. Select the wireless network you want to access and click **Connect**.
3. Provide passwords and encryption keys as prompted. A network protected with a password, encryption key, or both will be indicated by the secure connection icon . Contact your network administrator for more information, if needed.

Enabling and disabling Wake on LAN (WOL) function

Wake on LAN (WOL) is a function that allows your device to be turned on by a message sent across your local area network, or LAN.

 **NOTE:** Wake on LAN only functions when a LAN cable is attached. WOL resets to its default setting (WOL-enabled) after a system restart.

 **NOTE:** Accessing the WOL function requires initiating a recovery and entering developer mode. Make sure that all of your files are saved to the cloud or to an external drive before proceeding.

The process for enabling and disabling WOL may change as the operating system is updated. For further information and updates, go to <http://www.hp.com/support>, and select your country. Follow the on-screen instructions to find documentation relevant to your device. See also <http://www.chromium.org/chromium-os/developer-information-for-chrome-os-devices> for information about accessing developer mode.

To turn this function on and off:

1. You must enter development mode to alter WOL settings. See <http://www.chromium.org/chromium-os/developer-information-for-chrome-os-devices> for directions about accessing developer mode on your device.
2. After initiating developer mode, the system restarts automatically, and you are prompted to set up your language and keyboard again and sign in to your user account.
3. After you sign in, you see the Chrome desktop. From here, press `ctrl + alt + F2` or `ctrl + alt + →` to enter console mode.
4. On the console screen, type `root` and press `enter`.
5. At the next prompt, type `ethtool -s eth0 wol d` and press `enter` to disable WOL function. To enable WOL function, type `ethtool -s eth0 wol g` and press `enter`.
6. Press `ctrl + alt + F1` or `ctrl + alt + →` to return to the Chrome desktop.



NOTE: Changes to Wake on LAN functions may be applied only when a LAN cable is attached. WOL will be reset to its default setting (WOL-enabled) after a system reboot.

Managing apps

You can expand the productivity and entertainment capabilities of your Chromebook with free or purchased apps that you can download directly to your device.

To find and install apps, go to the Chrome webstore at <https://chrome.google.com/webstore/user/purchases#user/purchases>. Using the store requires a Google account, but the store will maintain a list of every app you have ever installed, even if you've uninstalled them. This way, you'll never lose an app when you reformat the operating system. Apps update automatically, ensuring that you always have the most recent version installed.

To open an app you've installed:

- ▲ Click the Launcher icon  and select the app from the list, or select the icon for the app you want from the apps pinned to the shelf at the bottom of the main screen.

To pin or unpin an app to the shelf on the main screen:

- ▲ Click the Launcher icon , and select the app. Right-click the app, and then select **Pin to shelf**. To unpin an app, right-click it and select **Unpin**.

To uninstall an app:

- ▲ Click the Launcher icon , and select the app. Right-click the app, and then select **Remove from Chrome**.

For more information about managing apps, go to https://support.google.com/chrome_webstore/answer/1053346?hl=en.

4 Securing your Chromebox and information

Device security is essential for protecting the confidentiality, integrity, and availability of your information. Standard security solutions and third-party software can help protect your device from a variety of risks, such as viruses, worms, and other types of malicious code.

When you sign in to Chrome and enable sync, Chrome keeps your information secure by using your Google Account credentials to encrypt your synced passwords. Alternatively, you can encrypt all of your synced data with a sync passphrase. This sync passphrase is stored on your device and isn't sent to Google. For more information on syncing your data, go to <https://support.google.com/chrome/answer/1181035?hl=en>.



IMPORTANT: Some security features listed in this chapter might not be available on your device.

Table 4-1 Chromebox security options

Device risk	Security feature
Unauthorized use of the device	Power-on password
Viruses	Antivirus software
Ongoing or future threats to the device	Software updates
Unauthorized removal of the device	Security cable lock

Securing your wireless network

When you set up your wireless network, always enable security features.

Backing up your software applications and information

All apps update automatically, and a record of your downloads and purchases is kept in the Chrome Store. Google also saves your last synced settings automatically. If you must perform a recovery on your device, you can log in with your Google account and automatically retrieve all of your settings, favorites, and apps.

HP recommends that you save important documents and files either to a USB flash drive, memory card, external hard drive, or to Google Cloud™ storage. You can save your files to the cloud at any time by selecting the Google Drive as your file-save location.

Recovering your Chromebox

If you want to give your Chromebox to someone else, reset owner permissions, or solve problems with your account profile, you can clear all local user data by resetting your device.



NOTE: Performing a factory reset deletes all data stored on your device, including permissions, settings, and user-owned files for all accounts. Resetting your device does not affect your accounts or any data synced to those accounts.

1. Select the status area in the lower-right corner.
2. Select **Settings**, and then select **Show advanced settings**.

3. Find the Powerwash section and click **Powerwash**.
4. After the dialog box opens, select **Restart**.

For more detailed information about resetting your Chromebox, see <https://support.google.com/chromebook/answer/183084>.

Using an optional security cable

A security cable lock, which is purchased separately, is designed to act as a deterrent, but it may not prevent the device from being mishandled or stolen. Security cables are only one of several methods that you should use as part of a complete security system to help maximize theft prevention.

The security cable slot on your Chromebox may look slightly different from the illustration in this section. For the location of the security cable slot on your device, see [Getting to know your Chromebox on page 1](#).

1. Loop the security cable lock around a secured object.
2. Insert the key (1) into the security cable lock (2).
3. Insert the security cable lock into the security cable slot on the device (3), and then lock the security cable lock with the key.

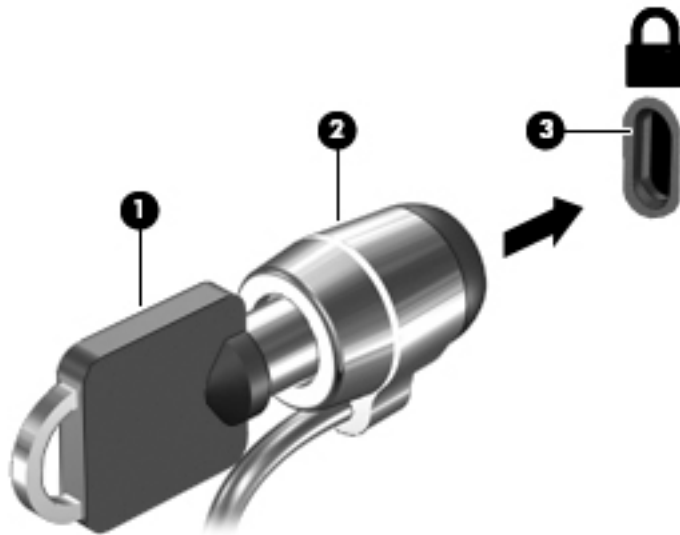

4. Remove the key and keep it in a safe place.

5 Printing

Use one of the following methods to print from your computer:

- Print from the Google Chrome™ browser
- Print with Google Cloud Print™ web printing service



NOTE: If you use HP Print for Chrome, the printer cannot be registered with Google Cloud Print.

Printing from Google Chrome

To print from Google Chrome, use the HP Print for Chrome app. You can install the HP Print for Chrome app from the Chrome Web Store. For more information, see the HP website.

1. Go to <http://www.hp.com/support>.
2. In the **Search our knowledge library** box, type `Printing with the HP Print for Chrome App`, and then follow the on-screen instructions.

Printing with Google Cloud Print Web printing service

Google Cloud Print Web printing service is a free service that allows you to print documents and photos securely from your computer. For information about prerequisites and steps for using Google Cloud Print, see the HP website.

1. Go to <http://www.hp.com/support>.
2. In the **Search our knowledge library** box, type `Connecting and Using Google Cloud Print`, and then follow the on-screen instructions.

6 More HP resources

More HP resources

To locate resources that provide product details, how-to information, and more, use this table.

Table 6-1 Additional HP resources

Resource	Contents
<i>Setup Instructions</i>	<ul style="list-style-type: none">• How to set up the computer• Help to identify computer components
HP website To access the latest user guide, go to http://www.hp.com/support , and follow the instructions to find your product. Then select User Guides .	<ul style="list-style-type: none">• Support information• Ordering parts and finding additional help• Accessories available for the device
Worldwide support To get support in your language, go to http://www.hp.com/support , and select your country.	<ul style="list-style-type: none">• Online chat with an HP technician• Support telephone numbers• HP service center locations
<i>Safety & Comfort Guide</i> Go to http://www.hp.com/ergo .	<ul style="list-style-type: none">• Proper workstation setup• Guidelines for posture and work habits that increase comfort and decrease risk of injury• Electrical and mechanical safety information
<i>Regulatory, Safety, and Environmental Notices</i> This guide is provided in the box.	<ul style="list-style-type: none">• Regulatory and safety information• Battery disposal information
<i>Limited Warranty*</i> Go to http://www.hp.com/go/orderdocuments .	<ul style="list-style-type: none">• Warranty information

*You can find your HP Limited Warranty located with the user guides on your product and/or on the CD or DVD provided in the box. In some countries or regions, HP may provide a printed warranty in the box. For countries or regions where the warranty is not provided in printed format, you can request a copy from <http://www.hp.com/go/orderdocuments>. For products purchased in Asia Pacific, you can write to HP at POD, PO Box 161, Kitchener Road Post Office, Singapore 912006. Include your product name, and your name, phone number, and postal address.

7 Electrostatic discharge

Electrostatic discharge is the release of static electricity when two objects come into contact—for example, the shock you receive when you walk across the carpet and touch a metal door knob.

A discharge of static electricity from fingers or other electrostatic conductors may damage electronic components.



IMPORTANT: To prevent damage to the computer, damage to a drive, or loss of information, observe these precautions:

- If removal or installation instructions direct you to unplug the computer, first be sure that it is properly grounded.
 - Keep components in their electrostatic-safe containers until you are ready to install them.
 - Avoid touching pins, leads, and circuitry. Handle electronic components as little as possible.
 - Use nonmagnetic tools.
 - Before handling components, discharge static electricity by touching an unpainted metal surface.
 - If you remove a component, place it in an electrostatic-safe container.
-

8 Accessibility

HP and accessibility

Because HP works to weave diversity, inclusion, and work/life into the fabric of the company, it is reflected in everything HP does. HP strives to create an inclusive environment focused on connecting people to the power of technology throughout the world.

Finding the technology tools you need

Technology can unleash your human potential. Assistive technology removes barriers and helps you create independence at home, at work, and in the community. Assistive technology helps increase, maintain, and improve the functional capabilities of electronic and information technology. For more information, see [Finding the best assistive technology on page 18](#).

The HP commitment

HP is committed to providing products and services that are accessible for people with disabilities. This commitment supports the company's diversity objectives and helps ensure that the benefits of technology are available to all.

The HP accessibility goal is to design, produce, and market products and services that can be effectively used by everyone, including people with disabilities, either on a stand-alone basis or with appropriate assistive devices.

To achieve that goal, this Accessibility Policy establishes seven key objectives to guide HP actions. All HP managers and employees are expected to support these objectives and their implementation in accordance with their roles and responsibilities:

- Raise the level of awareness of accessibility issues within HP, and provide employees with the training they need to design, produce, market, and deliver accessible products and services.
- Develop accessibility guidelines for products and services, and hold product development groups accountable for implementing these guidelines where competitively, technically, and economically feasible.
- Involve people with disabilities in the development of accessibility guidelines and in the design and testing of products and services.
- Document accessibility features, and make information about HP products and services publicly available in an accessible form.
- Establish relationships with leading assistive technology and solution providers.
- Support internal and external research and development that improves assistive technology relevant to HP products and services.
- Support and contribute to industry standards and guidelines for accessibility.

International Association of Accessibility Professionals (IAAP)

IAAP is a not-for-profit association focused on advancing the accessibility profession through networking, education, and certification. The objective is to help accessibility professionals develop and advance their careers and to better enable organizations to integrate accessibility into their products and infrastructure.

As a founding member, HP joined to participate with other organizations to advance the field of accessibility. This commitment supports HP's accessibility goal of designing, producing, and marketing products and services that people with disabilities can effectively use.

IAAP will make the profession strong by globally connecting individuals, students, and organizations to learn from one another. If you are interested in learning more, go to <http://www.accessibilityassociation.org> to join the online community, sign up for newsletters, and learn about membership options.

Finding the best assistive technology

Everyone, including people with disabilities or age-related limitations, should be able to communicate, express themselves, and connect with the world using technology. HP is committed to increasing accessibility awareness within HP and with our customers and partners. Whether it's large fonts that are easy on the eyes, voice recognition that lets you give your hands a rest, or any other assistive technology to help with your specific situation—a variety of assistive technologies make HP products easier to use. How do you choose?

Assessing your needs

Technology can unleash your potential. Assistive technology removes barriers and helps you create independence at home, at work, and in the community. Assistive technology (AT) helps increase, maintain, and improve the functional capabilities of electronic and information technology.

You can choose from many AT products. Your AT assessment should allow you to evaluate several products, answer your questions, and facilitate your selection of the best solution for your situation. You will find that professionals qualified to do AT assessments come from many fields, including those licensed or certified in physical therapy, occupational therapy, speech/language pathology, and other areas of expertise. Others, while not certified or licensed, can also provide evaluation information. You will want to ask about the individual's experience, expertise, and fees to determine if they are appropriate for your needs.

Accessibility for HP products

The following links provide information about accessibility features and assistive technology, if applicable, included in various HP products. These resources will help you select the specific assistive technology features and product(s) most appropriate for your situation.

- [HP Elite x3—Accessibility Options \(Windows 10 Mobile\)](#)
- [HP PCs—Windows 7 Accessibility Options](#)
- [HP PCs—Windows 8 Accessibility Options](#)
- [HP PC's—Windows 10 Accessibility Options](#)
- [HP Slate 7 Tablets—Enabling Accessibility Features on Your HP Tablet \(Android 4.1/Jelly Bean\)](#)
- [HP SlateBook PCs—Enabling Accessibility Features \(Android 4.3,4.2/Jelly Bean\)](#)
- [HP Chromebook PCs—Enabling Accessibility Features on Your HP Chromebook or Chromebox \(Chrome OS\)](#)
- [HP Shopping—peripherals for HP products](#)

If you need additional support with the accessibility features on your HP product, see [Contacting support on page 21](#).

Additional links to external partners and suppliers that may provide additional assistance:

- [Microsoft Accessibility information \(Windows 7, Windows 8, Windows 10, Microsoft Office\)](#)
- [Google Products accessibility information \(Android, Chrome, Google Apps\)](#)

- [Assistive Technologies sorted by impairment type](#)
- [Assistive Technologies sorted by product type](#)
- [Assistive Technology vendors with product descriptions](#)
- [Assistive Technology Industry Association \(ATIA\)](#)

Standards and legislation

Standards

Section 508 of the Federal Acquisition Regulation (FAR) standards was created by the US Access Board to address access to information and communication technology (ICT) for people with physical, sensory, or cognitive disabilities. The standards contain technical criteria specific to various types of technologies, as well as performance-based requirements which focus on functional capabilities of covered products. Specific criteria cover software applications and operating systems, web-based information and applications, computers, telecommunications products, video and multimedia, and self-contained closed products.

Mandate 376 – EN 301 549

The EN 301 549 standard was created by the European Union within Mandate 376 as the basis for an online toolkit for public procurement of ICT products. The standard specifies the functional accessibility requirements applicable to ICT products and services, together with a description of the test procedures and evaluation methodology for each accessibility requirement.

Web Content Accessibility Guidelines (WCAG)

Web Content Accessibility Guidelines (WCAG) from the W3C's Web Accessibility Initiative (WAI) helps web designers and developers create sites that better meet the needs of people with disabilities or age-related limitations. WCAG advances accessibility across the full range of web content (text, images, audio, and video) and web applications. WCAG can be precisely tested, is easy to understand and use, and allows web developers flexibility for innovation. WCAG 2.0 has also been approved as [ISO/IEC 40500:2012](#).

WCAG specifically addresses barriers to accessing the web experienced by people with visual, auditory, physical, cognitive, and neurological disabilities, and by older web users with accessibility needs. WCAG 2.0 provides characteristics of accessible content:

- **Perceivable** (for instance, by addressing text alternatives for images, captions for audio, adaptability of presentation, and color contrast)
- **Operable** (by addressing keyboard access, color contrast, timing of input, seizure avoidance, and navigability)
- **Understandable** (by addressing readability, predictability, and input assistance)
- **Robust** (for instance, by addressing compatibility with assistive technologies)

Legislation and regulations

Accessibility of IT and information has become an area of increasing legislative importance. The links listed below provide information about key legislation, regulations, and standards.

- [United States](#)
- [Canada](#)
- [Europe](#)

- [United Kingdom](#)
- [Australia](#)
- [Worldwide](#)

Useful accessibility resources and links

The following organizations might be good resources for information about disabilities and age-related limitations.



NOTE: This is not an exhaustive list. These organizations are provided for informational purposes only. HP assumes no responsibility for information or contacts you encounter on the Internet. Listing on this page does not imply endorsement by HP.

Organizations

- American Association of People with Disabilities (AAPD)
- The Association of Assistive Technology Act Programs (ATAP)
- Hearing Loss Association of America (HLAA)
- Information Technology Technical Assistance and Training Center (ITTATC)
- Lighthouse International
- National Association of the Deaf
- National Federation of the Blind
- Rehabilitation Engineering & Assistive Technology Society of North America (RESNA)
- Telecommunications for the Deaf and Hard of Hearing, Inc. (TDI)
- W3C Web Accessibility Initiative (WAI)

Educational institutions

- California State University, Northridge, Center on Disabilities (CSUN)
- University of Wisconsin - Madison, Trace Center
- University of Minnesota computer accommodations program

Other disability resources

- ADA (Americans with Disabilities Act) Technical Assistance Program
- ILO Global Business and Disability network
- EnableMart
- European Disability Forum
- Job Accommodation Network
- Microsoft Enable

HP links

[Our contact webform](#)

[HP comfort and safety guide](#)

[HP public sector sales](#)

Contacting support

 **NOTE:** Support is in English only.

- Customers who are deaf or hard of hearing who have questions about technical support or accessibility of HP products:
 - Use TRS/VRS/WebCapTel to call (877) 656-7058 Monday through Friday, 6 a.m. to 9 p.m. Mountain Time.
- Customers with other disabilities or age-related limitations who have questions about technical support or accessibility of HP products, choose one of the following options:
 - Call (888) 259-5707 Monday through Friday, 6 a.m. to 9 p.m. Mountain Time.
 - Complete the [Contact form for people with disabilities or age-related limitations](#).

Index

- A**
 - accessibility 17
 - accessibility needs assessment 18
 - action keys 8
 - back 8
 - brightness down 8
 - brightness up 8
 - esc 8
 - forward 8
 - full screen 8
 - mute 8
 - volume down 8
 - volume up 8
 - apps
 - managing apps 11
 - assistive technology (AT)
 - finding 18
 - purpose 17
 - AT (assistive technology)
 - finding 18
 - purpose 17
 - audio-in (microphone) jack,
 - identifying 2
 - audio-out (headphone) jack,
 - identifying 2
- B**
 - backing up software and information 12
 - Bluetooth label 7
 - bottom 7
- C**
 - components
 - bottom 5
 - front 2
 - rear 4
 - right side 1
 - customer support, accessibility 21
- E**
 - electrostatic discharge 16
 - external keyboard
 - functions 8
 - using 8
- H**
 - HDMI port, connecting 9
 - HDMI port, identifying 4
 - headphone (audio-out) jack 2
 - headphones, connecting 9
 - high-definition devices, connecting 9
 - HP Assistive Policy 17
- I**
 - installing
 - optional security cable lock 13
 - International Association of Accessibility Professionals 17
- J**
 - jacks
 - audio-in (microphone) 2
 - audio-out (headphone) 2
- L**
 - labels
 - Bluetooth 7
 - regulatory 7
 - serial number 6
 - service 6
 - wireless certification 7
 - WLAN 7
- M**
 - memory card reader, identifying 2
 - memory card, identifying 2
 - microphone (audio-in) jack,
 - identifying 2
 - mouse
 - functions 8
 - using 8
- N**
 - Next window 8
- P**
 - ports
 - HDMI 4, 9
 - USB 3.0 4
 - USB 3.0 charging 2
 - USB Type-C port 1
 - USB Type-C with HP Sleep and Charge 4
 - printing 14
 - product name and number, computer 6
- R**
 - regulatory information
 - regulatory label 7
 - wireless certification labels 7
 - resources 15
 - resources, accessibility 20
- S**
 - Section 508 accessibility standards 19
 - security cable lock, installing 13
 - security cable slot, identifying 1
 - serial number 6
 - serial number, computer 6
 - service labels, locating 6
 - slots
 - memory card reader 2
 - security cable 1
 - speakers, connecting 9
 - standards and legislation, accessibility 19
 - support 15
- T**
 - traveling with the computer 7
- U**
 - USB 3.0 ports, charging, identifying 2
 - USB 3.0 ports, identifying 4
 - USB Type-C port with HP Sleep and Charge, identifying 4
 - USB Type-C, identifying 1
- V**
 - vent, identifying 5
 - video 9

W

- wireless certification label 7
- wireless network, connecting 10
- wireless network, securing 12
- WLAN device 7
- WLAN label 7