

## PowerShot D30

# Camera User Guide

ENGLISH

- Make sure you read this guide, including the “Safety Precautions” (📖7) section, before using the camera.
- Reading this guide will help you learn to use the camera properly.
- Store this guide safely so that you can use it in the future.
- Click the buttons in the lower right to access other pages.
  - ▶: Next page
  - ◀: Previous page
  - 🔗: Page before you clicked a link
- To jump to the beginning of a chapter, click the chapter title at right.  
From chapter title pages, you can access topics by clicking their titles.

Before Use

Basic Guide

Advanced Guide

Camera Basics

Using GPS  
Functions

Auto Mode

Other Shooting  
Modes

P Mode

Playback Mode

Setting Menu

Accessories

Appendix

Index



## Package Contents

Before use, make sure the following items are included in the package. If anything is missing, contact your camera retailer.

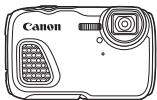

Camera



Battery Pack  
NB-6LH



Battery Charger  
CB-2LY/CB-2LYE

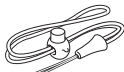

Wrist Strap

Printed Matter

- A memory card is not included (📖2).

## Compatible Memory Cards

The following memory cards (sold separately) can be used, regardless of capacity.

- SD memory cards\*
- SDHC memory cards\*
- SDXC memory cards\* 
- Eye-Fi cards

\* Cards conforming to SD standards. However, not all memory cards have been verified to work with the camera.

### About Eye-Fi Cards

This product is not guaranteed to support Eye-Fi card functions (including wireless transfer). In case of an issue with an Eye-Fi card, please check with the card manufacturer.

Also note that an approval is required to use Eye-Fi cards in many countries or regions. Without approval, use of the card is not permitted. If it is unclear whether the card has been approved for use in the area, please check with the card manufacturer.

Before Use

Basic Guide

Advanced Guide

Camera Basics

Using GPS  
Functions

Auto Mode

Other Shooting  
Modes

P Mode

Playback Mode

Setting Menu

Accessories

Appendix

Index



## Preliminary Notes and Legal Information

- Take and review some test shots initially to make sure the images were recorded correctly. Please note that Canon Inc., its subsidiaries and affiliates, and its distributors are not liable for any consequential damages arising from any malfunction of a camera or accessory, including memory cards, that result in the failure of an image to be recorded or to be recorded in a way that is machine readable.
- Images recorded by the camera shall be for personal use. Refrain from unauthorized recording that infringes on copyright law, and note that even for personal use, photography may contravene copyright or other legal rights at some performances or exhibitions, or in some commercial settings.
- The camera warranty is valid only in the area of purchase. In case of camera problems while abroad, return to the area of purchase before contacting a Canon Customer Support Help Desk.
- Although the LCD monitor is produced under extremely high-precision manufacturing conditions and more than 99.99% of the pixels meet design specifications, in rare cases some pixels may be defective or may appear as red or black dots. This does not indicate camera damage or affect recorded images.
- The LCD monitor may be covered with a thin plastic film for protection against scratches during shipment. If covered, remove the film before using the camera.
- When the camera is used over an extended period, it may become warm. This does not indicate damage.

Before Use

Basic Guide

Advanced Guide

Camera Basics

Using GPS Functions

Auto Mode

Other Shooting Modes

P Mode

Playback Mode

Setting Menu

Accessories

Appendix

Index



## Part Names and Conventions in This Guide

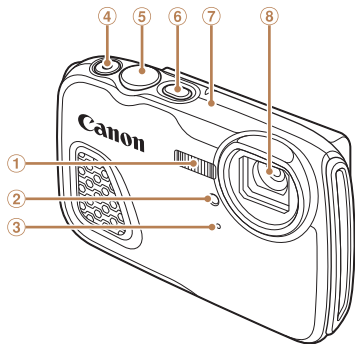

- ① Flash
- ② Lamp
- ③ Microphone
- ④ Movie button
- ⑤ Shutter button
- ⑥ Power button
- ⑦ GPS antenna
- ⑧ Lens

- In this guide, icons are used to represent the corresponding camera buttons on which they appear, or which they resemble.
- ⓘ: Important information you should know
- 🔧: Notes and tips for expert camera use
- 📖xx: Pages with related information (in this example, "xx" represents a page number)
- Instructions in this guide apply to the camera under default settings.
- For convenience, all supported memory cards are simply referred to as the "memory card".
- The tabs shown above titles indicate whether the function is used for still images, movies, or both.

**Still Images** : Indicates that the function is used when shooting or viewing still images.

**Movies** : Indicates that the function is used when shooting or viewing movies.

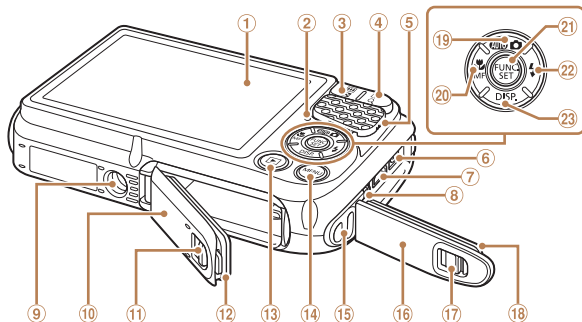

- ① Screen (LCD monitor)
- ② Indicator
- ③ Zoom button  
Shooting: (wide angle)  
Playback: (index)
- ④ Zoom button  
Shooting: (telephoto)  
Playback: (magnify)
- ⑤ Speaker
- ⑥ DC IN (Power input) terminal
- ⑦ HDMI™ terminal
- ⑧ AV OUT (Audio/video output) / DIGITAL terminal
- ⑨ Tripod socket
- ⑩ Memory card/battery cover
- ⑪ Memory card/battery cover lock
- ⑫ Waterproof seal
- ⑬ (Playback)> button
- ⑭ **<MENU>** button
- ⑮ Strap mount
- ⑯ Terminal cover
- ⑰ Terminal cover lock
- ⑱ Waterproof seal
- ⑲ Mode selection/Up button
- ⑳ **<M>** (Macro)> / **<MF>** (Manual focus)> / Left button
- ㉑ **FUNC./SET** button
- ㉒ **<L>** (Flash)> / Right button
- ㉓ **<DISP. (Display)>** / Down button

- The following camera buttons and controls are represented by icons.
  - Up button ⑲ on back
  - Left button ⑳ on back
  - Right button ㉑ on back
  - Down button ㉓ on back
- Shooting modes and on-screen icons and text are indicated in brackets.

Before Use

Basic Guide

Advanced Guide

Camera Basics

Using GPS Functions

Auto Mode

Other Shooting Modes

P Mode

Playback Mode

Setting Menu

Accessories

Appendix

Index



# Table of Contents

Package Contents .....	2	<b>Using GPS Functions.....</b>	<b>28</b>
Compatible Memory Cards .....	2	Using GPS Functions .....	29
Preliminary Notes and Legal Information .....	3	<b>Auto Mode.....</b>	<b>34</b>
Part Names and Conventions in This Guide.....	4	Shooting with Camera-Determined Settings.....	35
Table of Contents .....	5	Common, Convenient Features...	40
Common Camera Operations.....	6	Image Customization Features...	43
Safety Precautions.....	7	Helpful Shooting Features .....	46
		Customizing Camera Operation .....	47
<b>Basic Guide .....</b>	<b>10</b>	<b>Other Shooting Modes .....</b>	<b>50</b>
Cautions When Using This Waterproof, Dustproof, and Shock Resistant Camera .....	11	Specific Scenes .....	51
Initial Preparations .....	12	Applying Special Effects .....	54
Trying the Camera Out .....	18	Special Modes for Other Purposes.....	59
		Shooting Various Movies .....	64
<b>Advanced Guide .....</b>	<b>22</b>	<b>P Mode.....</b>	<b>66</b>
<b>Camera Basics.....</b>	<b>22</b>	Shooting in Program AE ([P] Mode) .....	67
On/Off .....	23	Image Brightness (Exposure) .....	67
Shutter Button .....	24	Color and Continuous Shooting...	69
Shooting Display Options .....	24	Flash .....	77
Using the FUNC. Menu.....	25		
Using Menus .....	26		
Indicator Display .....	27		
Clock .....	27		

<b>Playback Mode.....</b>	<b>79</b>	<b>Appendix .....</b>	<b>132</b>
Viewing .....	80	Troubleshooting .....	133
Browsing and Filtering Images .....	83	On-Screen Messages .....	135
Image Viewing Options .....	85	On-Screen Information .....	137
Protecting Images .....	87	Functions and Menu Tables .....	140
Erasing Images .....	90	Handling Precautions.....	146
Rotating Images.....	93	Specifications.....	147
Image Categories .....	94	Index .....	150
Editing Still Images .....	97		
Editing Movies.....	101		
<b>Setting Menu .....</b>	<b>103</b>		
Adjusting Basic Camera Functions .....	104		
<b>Accessories .....</b>	<b>112</b>		
System Map .....	113		
Optional Accessories .....	114		
Using Optional Accessories .....	115		
Using the Software .....	119		
Printing Images.....	122		
Using an Eye-Fi Card.....	130		

Before Use

Basic Guide

Advanced Guide

Camera Basics

Using GPS Functions

Auto Mode

Other Shooting Modes

P Mode

Playback Mode

Setting Menu

Accessories

Appendix

Index



# Common Camera Operations

## Shoot

- Use camera-determined settings (Auto Mode) ..... 35

### Matching specific scenes



Under Water  
(51)



Underwater Close-ups  
(51)



Night Scenes  
(52)



Low Light  
(51)



Fireworks  
(52)

### Shooting people well



Against Snow  
(51)



Portraits  
(51)

### Applying special effects



Fish-Eye Effect  
(54)



Miniature Effect  
(55)



Toy Camera Effect  
(56)



Monochrome  
(56)



Vivid Colors  
(54)



Poster Effect  
(54)

- Focus on faces..... 35, 51, 74
- Without using the flash (Flash Off)..... 42, 77
- Include yourself in the shot (Self-Timer) ..... 40, 61
- Add a date stamp ..... 42
- Movie clips and photos together (Movie Digest) ..... 59

## View

- View images (Playback Mode)..... 80
- Automatic playback (Slideshow) ..... 86
- On a TV ..... 115
- On a computer ..... 120
- Browse through images quickly ..... 83
- Erase images ..... 90

Before Use

Basic Guide

Advanced Guide

Camera Basics

Using GPS  
Functions

Auto Mode

Other Shooting  
Modes

P Mode

Playback Mode

Setting Menu

Accessories

Appendix

Index



## Shoot/View Movies

- Shoot movies ..... 35, 64
- View movies (Playback Mode) ..... 80
- Fast-moving subjects, slow-motion playback..... 64

## Print

- Print pictures ..... 122

## Save

- Save images to a computer ..... 121

## Other Operations

- Use GPS functions..... 28
- Make the screen easier to see in bright conditions..... 105

## Safety Precautions

- Before using the product, ensure that you read the safety precautions described below. Always ensure that the product is used correctly.
- The safety precautions noted here are intended to prevent you and other persons from being injured or incurring property damage.
- Be sure to also check the guides included with any separately sold accessories you use.



### Warning

Denotes the possibility of serious injury or death.

- **Do not trigger the flash in close proximity to people's eyes.**  
Exposure to the intense light produced by the flash could damage eyesight. In particular, remain at least 1 meter (3.3 feet) away from infants when using the flash.

- **Store this equipment out of the reach of children and infants.**  
A strap wound around a child's neck may result in asphyxiation. If your product uses a power cord, mistakenly winding the cord around a child's neck may result in asphyxiation.

- **Use only recommended power sources.**
- **Do not disassemble, alter, or apply heat to the product.**
- **Avoid dropping or subjecting the product to severe impacts.**
- **Do not touch the interior of the product if it is broken, such as when dropped.**
- **Stop using the product immediately if it emits smoke or a strange smell, or otherwise behaves abnormally.**
- **Do not use organic solvents such as alcohol, benzene, or thinner to clean the product.**
- **Do not allow liquids or foreign objects to enter the product.**

This could result in electrical shock or fire.

If liquid or foreign objects get inside the product, remove the battery pack immediately, and if the battery charger gets wet, unplug it.

Before Use

Basic Guide

Advanced Guide

Camera Basics

Using GPS  
Functions

Auto Mode

Other Shooting  
Modes

P Mode

Playback Mode

Setting Menu

Accessories

Appendix

Index



- **Do not look through the viewfinder (if your model has one) at intense light sources, such as the sun on a clear day or an intense artificial light source.**

This could damage your eyesight.

- **Do not touch the product during thunderstorms if it is plugged in.**

This could result in electrical shock or fire. Immediately stop using the product and distance yourself from it.

- **Use only the recommended battery pack/batteries.**
- **Do not place the battery pack/batteries near or in direct flame.**

This may cause the battery pack/batteries to explode or leak, resulting in electrical shock, fire, or injuries. If leaking battery electrolyte comes into contact with eyes, mouth, skin, or clothing, immediately flush with water.

- **If the product uses a battery charger, note the following precautions.**

- **Remove the plug periodically and, using a dry cloth, wipe away any dust and dirt that has collected on the plug, the exterior of the power outlet, and the surrounding area.**
- **Do not insert or remove the plug with wet hands.**
- **Do not use the equipment in a manner that exceeds the rated capacity of the electrical outlet or wiring accessories. Do not use if the plug is damaged or not fully inserted in the outlet.**
- **Do not allow dust or metal objects (such as pins or keys) to contact the terminals or plug.**
- **Do not cut, damage, alter, or place heavy items on the power cord, if your product uses one.**

This could result in electrical shock or fire.

- **Turn the camera off in places where camera use is prohibited.**

The electromagnetic waves emitted by the camera may interfere with the operation of electronic instruments and other devices. Exercise adequate caution when using the product in places where use of electronic devices is restricted, such as inside airplanes and medical facilities.



## Caution

Denotes the possibility of injury.

- **When carrying the product by the strap, be careful not to bang it, subject it to strong impacts or shocks, or let it get caught on other objects.**
- **Be careful not to subject the screen to strong impacts.**  
If the screen cracks, injury may result from the broken fragments.
- **When using the flash, be careful not to cover it with your fingers or clothing.**  
This could result in burns or damage to the flash.
- **Avoid using, placing, or storing the product in the following places:**
  - **Places subject to direct sunlight**
  - **Places subject to temperatures above 40 °C (104 °F)**
  - **Humid or dusty places**These could cause leakage, overheating, or an explosion of the battery pack/batteries, resulting in electrical shock, fire, burns, or other injuries. Overheating and damage may result in electrical shock, fire, burns, or other injuries.
- **The slideshow transition effects may cause discomfort when viewed for prolonged periods.**
- **When using optional lenses, lens filters, or filter adapters (if applicable), be sure to attach these accessories firmly.**  
If the lens accessory becomes loose and falls off, it may crack, and the shards of glass may lead to cuts.
- **On products that raise and lower the flash automatically, make sure to avoid pinching your fingers with the lowering flash.**  
This could result in injury.

Before Use

Basic Guide

Advanced Guide

Camera Basics

Using GPS  
Functions

Auto Mode

Other Shooting  
Modes

P Mode

Playback Mode

Setting Menu

Accessories

Appendix

Index





## Caution

Denotes the possibility of property damage.

- **Do not aim the camera at intense light sources, such as the sun on a clear day or an intense artificial light source.**

Doing so may damage the image sensor or other internal components.

- **This product cannot be used underwater at a depth greater than 25 meters (82 ft.), or in hot springs and other mineralized waters.**

This may cause product damage or water leakage.

- **When using the camera on a sandy beach or at a windy location, be careful not to allow dust or sand to enter the camera.**
- **On products that raise and lower the flash automatically, do not push the flash down or pry it open.**

This may cause the product to malfunction.

- **Wipe off any dust, grime, or other foreign matter on the flash with a cotton swab or cloth.**

The heat emitted from the flash may cause foreign matter to smoke or the product to malfunction.

- **Remove and store the battery pack/batteries when you are not using the product.**

Any battery leakage that occurs may cause product damage.

- **Keep the covers closed when the product is not in use.**

Storing the product with the covers open may damage it if liquid or dust gets inside.

- **Before you discard the battery pack/batteries, cover the terminals with tape or other insulators.**

Contacting other metal materials may lead to fire or explosions.

- **Unplug any battery charger used with the product when not in use. Do not cover with a cloth or other objects when in use.**

Leaving the unit plugged in for a long period of time may cause it to overheat and distort, resulting in fire.

- **Do not leave any dedicated battery packs near pets.**

Pets biting the battery pack could cause leakage, overheating, or explosion, resulting in product damage or fire.

- **If your product uses multiple batteries, do not use batteries that have different levels of charge together, and do not use old and new batteries together. Do not insert the batteries with the + and – terminals reversed.**

This may cause the product to malfunction.

- **Do not sit down with the camera in your pant pocket.**

Doing so may cause malfunctions or damage the screen.

- **When putting the camera in your bag, ensure that hard objects do not come into contact with the screen. Also close the screen (so that it faces the body), if your product's screen closes.**

- **Do not attach any hard objects to the product.**

Doing so may cause malfunctions or damage the screen.



Before Use

Basic Guide

Advanced Guide

Camera Basics

Using GPS  
Functions

Auto Mode

Other Shooting  
Modes

P Mode

Playback Mode

Setting Menu

Accessories

Appendix

Index



# Basic Guide

Basic information and instructions, from initial preparations to shooting and playback

<b>Cautions When Using This Waterproof, Dustproof, and Shock Resistant Camera .....</b>	<b>11</b>
Cautions Before Using This Camera .....	11
Cautions While Using This Camera .....	11
Cautions After Using This Camera and Camera Care .....	12
About the Waterproof Seals .....	12

<b>Initial Preparations.....</b>	<b>12</b>
Attaching the Strap.....	12
Holding the Camera .....	13
Charging the Battery Pack .....	13
Inserting the Battery Pack and Memory Card .....	14
Setting the Date and Time.....	15
Display Language .....	17

<b>Trying the Camera Out.....</b>	<b>18</b>
Shooting (Smart Auto).....	18
Viewing.....	20

Before Use

Basic Guide

Advanced Guide

Camera Basics

Using GPS Functions

Auto Mode

Other Shooting Modes

P Mode

Playback Mode

Setting Menu

Accessories

Appendix

Index



## Cautions When Using This Waterproof, Dustproof, and Shock Resistant Camera

You can enjoy using this camera in the rain, on the beach, while skiing, or underwater within a depth of 25 meters (82 ft.). However, it can not be used in hot springs or other mineralized waters.

Please be aware that Canon is not liable for any damage to the camera, battery packs, memory cards, or saved data caused by water leakage due to mistaken operation of the product. This camera is subjected to Canon testing standards. However, it is not guaranteed that this camera will not damage or malfunction. (For more information about waterproof, dustproof, and shock resistant specifications, see [147](#).)

### Cautions Before Using This Camera

- Before shooting with the camera, confirm that the memory card/battery cover and terminal cover ([4](#)) are fully closed ([15](#), [18](#)). If either cover is not fully closed, water may enter the camera and damage it.
- Be sure that the waterproof seals ([14](#)) inside the covers and the areas around them are kept free from scratches and foreign objects such as sand, dirt, or hair. These may cause leakage inside. If the waterproof seal is damaged, do not use the camera underwater.
- Avoid opening and closing the covers while on the beach or near water. Change memory cards and battery packs in a dry place protected from sea breezes.
- Do not open the covers if the camera is wet. If there is moisture on the camera, wipe it off with a soft, dry cloth until it is completely dry.

### Cautions While Using This Camera

- Do not use this camera in water deeper than 25 meters (82 ft.).
- Do not expose the camera to strong impacts or shocks while underwater. Impacts could cause the covers to open or otherwise compromise the waterproof ability of the camera.
- This camera is deemed shock resistant by Canon testing standards ([147](#)). However, strong impacts could scratch the camera or cause it to malfunction. Do not allow the camera to fall a great distance or expose it to excessive shocks.
- Waterproof performance is not ensured if the camera is dropped or subjected to impact.

Before Use

Basic Guide

Advanced Guide

Camera Basics

Using GPS Functions

Auto Mode

Other Shooting Modes

P Mode

Playback Mode

Setting Menu

Accessories

Appendix

Index



## Cautions After Using This Camera and Camera Care

- Rinse off the camera if there is liquid or sand on it after use. The liquid may soil or corrode the camera, and wiping the camera when sand is on it may scratch it.
- After using the camera under water or in sandy or muddy environments, promptly rinse it well under fresh water, such as tap water no warmer than 30 °C (86 °F). Foreign material or salty residue on the camera may corrode metal parts or cause buttons to stick.
- After washing the camera, dry it completely by wiping it with a soft, dry cloth. After washing and drying the camera, make sure the buttons and covers do not stick when pressed or opened and closed.
- To avoid damaging the waterproof seals and causing leaks, keep the seals free of sand or other foreign material, and do not apply chemicals or grease to the seals.

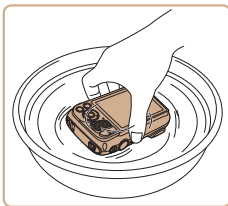

## About the Waterproof Seals

- Scratches or cracks in the waterproof seals could cause damage or leaks. Contact a Canon Customer Support Help Desk for immediate repair. The waterproof seal will be replaced on a chargeable basis.

## Initial Preparations

Prepare for shooting as follows.

### Attaching the Strap

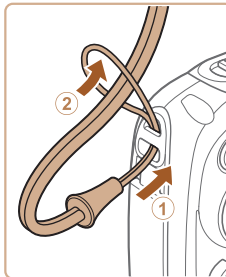

- Thread the end of the strap through the strap hole (①), and then pull the other end of the strap through the loop on the threaded end (②).

Before Use

Basic Guide

Advanced Guide

Camera Basics

Using GPS Functions

Auto Mode

Other Shooting Modes

P Mode

Playback Mode

Setting Menu

Accessories

Appendix

Index



## Holding the Camera

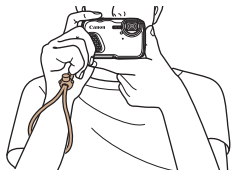

- Place the strap around your wrist.
- When shooting, keep your arms close to your body and hold the camera securely to prevent it from moving. Do not rest your fingers on the flash.

## Charging the Battery Pack

Before use, charge the battery pack with the included charger. Be sure to charge the battery pack initially, because the camera is not sold with the battery pack charged.



### 1 Insert the battery pack.

- After aligning the ▲ marks on the battery pack and charger, insert the battery pack by pushing it in (①) and down (②).

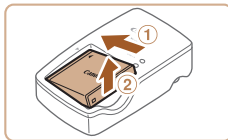
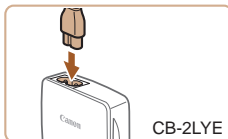
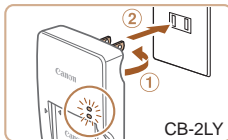

### 2 Charge the battery pack.

- **CB-2LY:** Flip out the plug (①) and plug the charger into a power outlet (②).
- **CB-2LYE:** Plug the power cord into the charger, then plug the other end into a power outlet.
- The charging lamp turns orange, and charging begins.
- When charging is finished, the lamp turns green.

### 3 Remove the battery pack.

- After unplugging the battery charger, remove the battery pack by pushing it in (①) and up (②).

- ⚠ To protect the battery pack and keep it in optimal condition, do not charge it continuously for more than 24 hours.
- For battery chargers that use a power cord, do not attach the charger or cord to other objects. Doing so could result in malfunction or damage to the product.

Before Use

Basic Guide

Advanced Guide

Camera Basics

Using GPS  
Functions

Auto Mode

Other Shooting  
Modes

P Mode

Playback Mode

Setting Menu

Accessories

Appendix

Index





- For details on charging time and the number of shots and recording time possible with a fully charged battery pack, see “Number of Shots/Recording Time, Playback Time” (147).
- Charged battery packs gradually lose their charge, even when they are not used. Charge the battery pack on (or immediately before) the day of use.
- The charger can be used in areas with 100 – 240 V AC power (50/60 Hz). For power outlets in a different format, use a commercially available adapter for the plug. Never use an electrical transformer designed for traveling, which may damage the battery pack.

## Inserting the Battery Pack and Memory Card

Insert the included battery pack and a memory card (sold separately). Note that before using a new memory card (or a memory card formatted in another device), you should format the memory card with this camera (106).

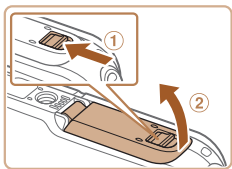

### 1 Open the cover.

- Slide the lock (1) and open the cover (2).

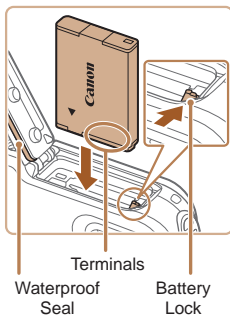

### 2 Insert the battery pack.

- While pressing the battery lock in the direction of the arrow, insert the battery pack as shown and push it in until it clicks into the locked position.
- If you insert the battery pack facing the wrong way, it cannot be locked into the correct position. Always confirm that the battery pack is facing the right way and locks when inserted.
- Be careful not to damage the waterproof seal when inserting the battery pack.

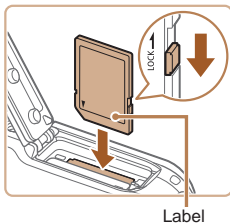

### 3 Check the card's write-protect tab and insert the memory card.

- Recording is not possible on memory cards with a write-protect tab when the tab is in the locked position. Slide the tab to the unlocked position.
- Insert the memory card facing as shown until it clicks into the locked position.
- Make sure the memory card is facing the right way when you insert it. Inserting memory cards facing the wrong way may damage the camera.
- Be careful not to damage the waterproof seal when inserting the memory card.

Before Use

Basic Guide

Advanced Guide

Camera Basics

Using GPS  
Functions

Auto Mode

Other Shooting  
Modes

P Mode

Playback Mode

Setting Menu

Accessories

Appendix

Index



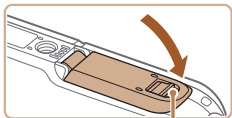

Red Mark

#### 4 Close the cover.

- Lower the cover in the direction of the arrow and press it until it clicks into the closed position.
- Make sure the lock returns to the position shown, with the red mark no longer visible.



- Do not open the covers when the camera is wet or submerged in water. If there is moisture on the camera, wipe it off with a soft, dry cloth until it is completely dry.
- Be sure that the waterproof seals and the areas around them are kept free from scratches and foreign objects such as sand, dirt, or hair. These may cause leakage inside.
- Avoid opening and closing the covers while on the beach or near water. Change memory cards and battery packs in a dry place protected from sea breezes.



- For guidelines on how many shots or hours of recording can be saved on one memory card, see “Number of 4:3 Shots per Memory Card” (148).

#### Removing the Battery Pack and Memory Card

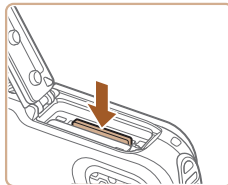
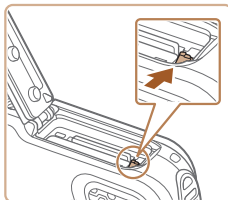

##### Remove the battery pack.

- Open the cover and press the battery lock in the direction of the arrow.
- The battery pack will pop up.

##### Remove the memory card.

- Push the memory card in until it clicks, and then slowly release it.
- The memory card will pop up.

#### Setting the Date and Time

Set the current date and time correctly as follows if the [Date/Time] screen is displayed when you turn the camera on. Information you specify this way is recorded in image properties when you shoot, and it is used when you manage images by shooting date or print images showing the date. You can also add a date stamp to shots, if you wish (42).

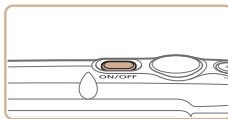

##### 1 Turn the camera on.

- Press the power button.
- The [Date/Time] screen is displayed.

Before Use

Basic Guide

Advanced Guide

Camera Basics

Using GPS Functions

Auto Mode

Other Shooting Modes

P Mode

Playback Mode

Setting Menu

Accessories

Appendix

Index



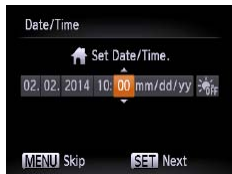

## 2 Set the date and time.

- Press the <◀>><▶> buttons to choose an option.
- Press the <▲>><▼> buttons to specify the date and time.
- When finished, press the <FUNC SET> button.

## 3 Set the home time zone.

- Press the <◀>><▶> buttons to choose your home time zone.

## 4 Finish the setup process.

- Press the <FUNC SET> button when finished. After a confirmation message, the setting screen is no longer displayed.
- To turn off the camera, press the power button.



- Unless you set the date, time, and home time zone, the [Date/Time] screen will be displayed each time you turn the camera on. Specify the correct information.



- To set daylight saving time (1 hour ahead), choose [☀️] in step 2 and then choose [🌑] by pressing the <▲>><▼> buttons.

## Changing the Date and Time

Adjust the date and time as follows.

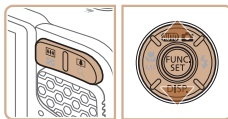
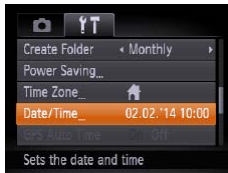
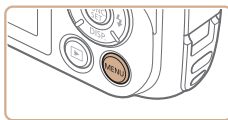

### 1 Access the camera menu.

- Press the <MENU> button.

### 2 Choose [Date/Time].

- Press the zoom button to choose the [↑↑] tab.
- Press the <▲>><▼> buttons to choose [Date/Time], and then press the <FUNC SET> button.

### 3 Change the date and time.

- Follow step 2 in “Setting the Date and Time” (📖16) to adjust the settings.
- Press the <MENU> button to close the menu.

Before Use

Basic Guide

Advanced Guide

Camera Basics

Using GPS Functions

Auto Mode

Other Shooting Modes

P Mode

Playback Mode

Setting Menu

Accessories

Appendix

Index







- Date/time settings can be retained for about 3 weeks by the camera's built-in date/time battery (backup battery) after the battery pack is removed.
- The date/time battery will be charged in about 4 hours once you insert a charged battery pack or connect the camera to an AC adapter kit (sold separately, [P114](#)), even if the camera is left off.
- Once the date/time battery is depleted, the [Date/Time] screen will be displayed when you turn the camera on. Set the correct date and time as described in "Setting the Date and Time" ([P15](#)).
- Automatic date and time updating is possible using GPS ([P33](#)).

## Display Language

Change the display language as needed.

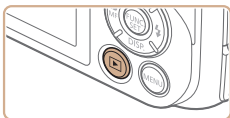

### 1 Enter Playback mode.

- Press the button.



### 2 Access the setting screen.

- Press and hold the button, and then immediately press the button.



### 3 Set the display language.

- Press the buttons to choose a language, and then press the button.
- Once the display language has been set, the setting screen is no longer displayed.



- The current time is displayed if you wait too long in step 2 after pressing the button before you press the button. In this case, press the button to dismiss the time display and repeat step 2.
- You can also change the display language by pressing the button and choosing [Language ] on the tab.

Before Use

Basic Guide

Advanced Guide

Camera Basics

Using GPS  
Functions

Auto Mode

Other Shooting  
Modes

P Mode

Playback Mode

Setting Menu

Accessories

Appendix

Index



## Trying the Camera Out

Follow these instructions to turn the camera on, shoot still images or movies, and then view them.

### Shooting (Smart Auto)

For fully automatic selection of the optimal settings for specific scenes, simply let the camera determine the subject and shooting conditions.

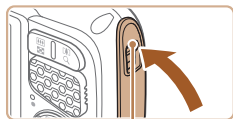

Red Mark

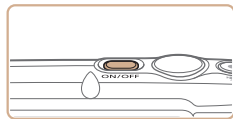
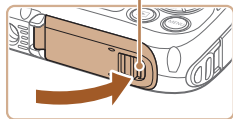

#### 1 Make sure the covers are closed.

- Make sure that both the memory card/battery cover lock and terminal cover lock return to the positions shown, with the red marks no longer visible.
- If either cover is not fully closed, water may enter the camera when it gets wet, which may damage it.

#### 2 Turn the camera on.

- Press the power button.
- The startup screen is displayed.

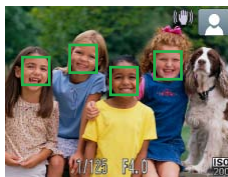
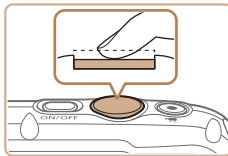
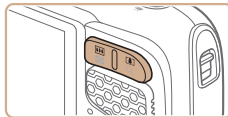

#### 3 Enter [AUTO] mode.

- Press the <▲> button, press the <▲><▼> buttons to choose [AUTO], and then press the <OK/SET> button.
- Icons representing the scene and image stabilization mode are displayed in the upper right of the screen.
- Frames displayed around any detected subjects indicate that they are in focus.

#### 4 Compose the shot.

- To zoom in and enlarge the subject, press the <📷> (telephoto) zoom button, and to zoom away from the subject, press the <📷> (wide angle) zoom button.

#### 5 Shoot.

##### Shooting Still Images

##### ① Focus.

- Press the shutter button lightly, halfway down. The camera beeps twice after focusing, and AF frames are displayed to indicate image areas in focus.

Before Use

Basic Guide

Advanced Guide

Camera Basics

Using GPS Functions

Auto Mode

Other Shooting Modes

P Mode

Playback Mode

Setting Menu

Accessories

Appendix

Index



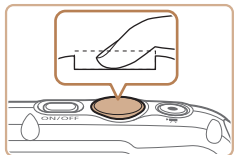

## ② Shoot.

- Press the shutter button all the way down.
- As the camera shoots, a shutter sound is played, and in low-light conditions, the flash fires automatically.
- Your shot remains displayed on the screen for about two seconds.
- Even while the shot is displayed, you can take another shot by pressing the shutter button again.

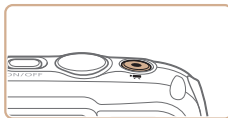

Elapsed Time

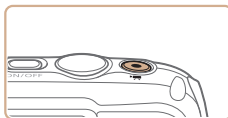

## Shooting Movies

### ① Start shooting.

- Press the movie button. The camera beeps once as recording begins, and [●Rec] is displayed with the elapsed time.
- Black bars displayed on the top and bottom edges of the screen indicate image areas not recorded.
- Once recording begins, take your finger off the movie button.

### ② Finish shooting.

- Press the movie button again to stop shooting. The camera beeps twice as recording stops.

Before Use

Basic Guide

Advanced Guide

Camera Basics

Using GPS  
Functions

Auto Mode

Other Shooting  
Modes

P Mode

Playback Mode

Setting Menu

Accessories

Appendix

Index



## Viewing

After shooting images or movies, you can view them on the screen as follows.

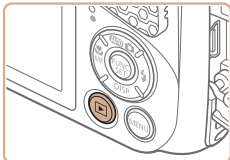

### 1 Enter Playback mode.

- Press the button.
- Your last shot is displayed.



### 2 Browse through your images.

- To view the previous image, press the button. To view the next image, press the button.

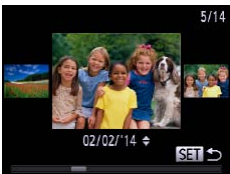

- To access Scroll Display mode, press and hold the buttons for at least one second. In this mode, press the buttons to browse through images.
- To return to single-image display, press the button.

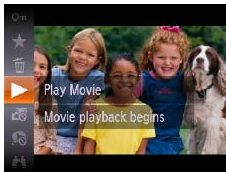

- Movies are identified by a icon. To play movies, go to step 3.

### 3 Play movies.

- Press the button, press the buttons to choose [▶], and then press the button again.
- Playback now begins, and after the movie is finished, is displayed.
- To adjust the volume, press the buttons.



- To switch to Shooting mode from Playback mode, press the shutter button halfway.

Before Use

Basic Guide

Advanced Guide

Camera Basics

Using GPS  
Functions

Auto Mode

Other Shooting  
Modes

P Mode

Playback Mode

Setting Menu

Accessories

Appendix

Index



## Erasing Images

You can choose and erase unneeded images one by one. Be careful when erasing images, because they cannot be recovered.

### 1 Choose an image to erase.

- Press the <◀><▶> buttons to choose an image.



### 2 Erase the image.

- Press the <FUNC SET> button, press the <▲><▼> buttons to choose [🗑️], and then press the <FUNC SET> button again.
- After [Erase?] is displayed, press the <◀><▶> buttons to choose [Erase], and then press the <FUNC SET> button.
- The current image is now erased.
- To cancel erasure, press the <◀><▶> buttons to choose [Cancel], and then press the <FUNC SET> button.



- You can also erase multiple images at once (📖91).

Before Use

Basic Guide

Advanced Guide

Camera Basics

Using GPS  
Functions

Auto Mode

Other Shooting  
Modes

P Mode

Playback Mode

Setting Menu

Accessories

Appendix

Index



## Camera Basics

Other basic operations and more ways to enjoy your camera, including shooting and playback options

<b>On/Off</b> .....	<b>23</b>	<b>Using the FUNC. Menu</b> .....	<b>25</b>
Power-Saving Features (Auto Power Down) .....	23	<b>Using Menus</b> .....	<b>26</b>
<b>Shutter Button</b> .....	<b>24</b>	<b>Indicator Display</b> .....	<b>27</b>
<b>Shooting Display Options</b> .....	<b>24</b>	<b>Clock</b> .....	<b>27</b>

Before Use

Basic Guide

Advanced Guide

Camera Basics

Using GPS  
Functions

Auto Mode

Other Shooting  
Modes

P Mode

Playback Mode

Setting Menu

Accessories

Appendix

Index



## On/Off

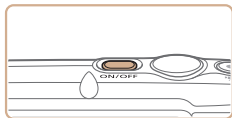

### Shooting Mode

- Press the power button to turn the camera on and prepare for shooting.
- To turn the camera off, press the power button again.

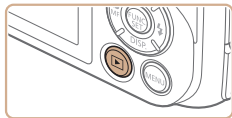

### Playback Mode

- Press the <▶> button to turn the camera on and view your shots.
- To turn the camera off, press the <▶> button again.



- To switch to Playback mode from Shooting mode, press the <▶> button.
- To switch to Shooting mode from Playback mode, press the shutter button halfway (📖24).
- The camera may not restart if you turn it off and press the power button again immediately. In this case, wait a moment before turning it on again.

## Power-Saving Features (Auto Power Down)

As a way to conserve battery power, the camera automatically deactivates the screen (Display Off) and then turns itself off after a specific period of inactivity.

### Power Saving in Shooting Mode

The screen turns off about a minute after the camera is last operated, and the indicator is lit in green. After about two more minutes, the power will turn off. To activate the screen and prepare for shooting when the screen is off and the indicator is green, press the shutter button halfway (📖24).

### Power Saving in Playback Mode

The camera turns itself off automatically after about five minutes of inactivity.



- You can deactivate Auto Power Down and adjust the timing of Display Off, if you prefer (📖108).

Before Use

Basic Guide

Advanced Guide

Camera Basics

Using GPS Functions

Auto Mode

Other Shooting Modes

P Mode

Playback Mode

Setting Menu

Accessories

Appendix

Index



## Shutter Button

To ensure your shots are in focus, always begin by holding the shutter button halfway down, and once the subject is in focus, press the button all the way down to shoot.

In this manual, shutter button operations are described as pressing the button *halfway* or *all the way down*.

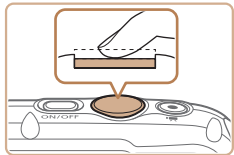

### 1 Press halfway. (Press lightly to focus.)

- Press the shutter button halfway. The camera beeps twice, and AF frames are displayed around image areas in focus.

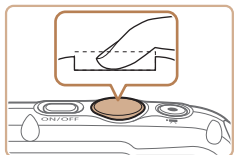

### 2 Press all the way down. (From the halfway position, press fully to shoot.)

- The camera shoots, as a shutter sound is played.
- Keep the camera still until the shutter sound ends.



- Images may be out of focus if you shoot without initially pressing the shutter button halfway.
- Length of shutter sound playback varies depending on the time required for the shot. It may take longer in some shooting scenes, and images will be blurry if you move the camera (or the subject moves) before the shutter sound ends.

## Shooting Display Options

Press the <▼> button to view other information on the screen, or to hide the information. For details on the information displayed, see “On-Screen Information” (📖137).

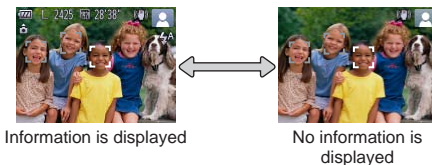

- Screen brightness is automatically increased by the night view function when you are shooting under low light, making it easier to check how shots are composed. However, on-screen image brightness may not match the brightness of your shots. Note that any on-screen image distortion or jerky subject motion will not affect recorded images.
- For playback display options, see “Switching Display Modes” (📖82).

Before Use

Basic Guide

Advanced Guide

Camera Basics

Using GPS Functions

Auto Mode

Other Shooting Modes

P Mode

Playback Mode

Setting Menu

Accessories

Appendix

Index





## Using the FUNC. Menu

Configure commonly used functions through the FUNC. menu as follows. Note that menu items and options vary depending on the shooting mode (📖141 – 142) or playback mode (📖146).



### 1 Access the FUNC. menu.

- Press the <FUNC. SET> button.



Menu Items

### 2 Choose a menu item.

- Press the <▲><▼> buttons to choose a menu item, and then press the <FUNC. SET> or <▶> button.
- Depending on the menu item, functions can be specified simply by pressing the <FUNC. SET> or <▶> button, or another screen is displayed for configuring the function.



### 3 Choose an option.

- Press the <▲><▼> buttons to choose an option.
- Options labeled with a [MENU] icon can be configured by pressing the <MENU> button.
- To return to the menu items, press the <◀> button.



### 4 Finish the setup process.

- Press the <FUNC. SET> button.
- The screen before you pressed the <FUNC. SET> button in step 1 is displayed again, showing the option you configured.



- To undo any accidental setting changes, you can restore the camera's default settings (📖110).

Before Use

Basic Guide

Advanced Guide

Camera Basics

Using GPS Functions

Auto Mode

Other Shooting Modes

P Mode

Playback Mode

Setting Menu

Accessories

Appendix

Index



## Using Menus

Configure a variety of camera functions through other menus as follows. Menu items are grouped by purpose on tabs, such as shooting [📷], playback [▶], and so on. Note that available menu items vary depending on the selected shooting or playback mode (📖143 – 146).

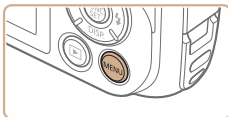

### 1 Access the menu.

- Press the <MENU> button.

### 2 Choose a tab.

- Press the zoom button to choose a tab.
- After you have pressed the <▲><▼> buttons to choose a tab initially, you can switch between tabs by pressing the <◀><▶> buttons.

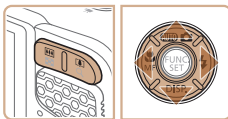

### 3 Choose a menu item.

- Press the <▲><▼> buttons to choose a menu item.
- For menu items with options not shown, first press the <FUNC SET> or <▶> button to switch screens, and then press the <▲><▼> buttons to select the menu item.
- To return to the previous screen, press the <MENU> button.

### 4 Choose an option.

- Press the <◀><▶> buttons to choose an option.

### 5 Finish the setup process.

- Press the <MENU> button to return to the screen displayed before you pressed the <MENU> button in step 1.



- To undo any accidental setting changes, you can restore the camera's default settings (📖110).

Before Use

Basic Guide

Advanced Guide

Camera Basics

Using GPS Functions

Auto Mode

Other Shooting Modes

P Mode

Playback Mode

Setting Menu

Accessories

Appendix

Index



## Indicator Display

The indicator on the back of the camera (📖4) lights up or blinks depending on the camera status.

Color	Indicator Status	Camera Status
Green	On	Connected to a computer (📖121), or display off (📖23, 108)
	Blinking	Starting up, recording/reading/transmitting images, shooting long exposures (📖62), or logger active (📖31)



- When the indicator blinks green, never turn the camera off, open the memory card/battery cover, or shake or jolt the camera, which may corrupt images or damage the camera or memory card.

## Clock

You can check the current time.

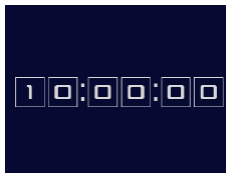

- When the camera is off, press and hold the <FUNC/SET> button, then press the power button to display the clock.

- Press and hold the <FUNC/SET> button.
- The current time appears.
- If you hold the camera vertically while using the clock function, it will switch to vertical display. Press the <◀>>> buttons to change the display color.
- Press the <FUNC/SET> button again to cancel the clock display.

Before Use

Basic Guide

Advanced Guide

Camera Basics

Using GPS Functions

Auto Mode

Other Shooting Modes

P Mode

Playback Mode

Setting Menu

Accessories

Appendix

Index



# Using GPS Functions

Basic GPS operations and features

<b>Using GPS Functions .....</b>	<b>29</b>
Where to Use GPS, and How to Hold the Camera .....	29
Using GPS Functions .....	30
Geotagging Images while Shooting .....	30
Logging Camera Location Data .....	31
Automatically Updating the Date and Time .....	33

Before Use

Basic Guide

Advanced Guide

Camera Basics

Using GPS  
Functions

Auto Mode

Other Shooting  
Modes

P Mode

Playback Mode

Setting Menu

Accessories

Appendix

Index



## Using GPS Functions

Camera location information (latitude, longitude, and elevation) based on signals acquired from GPS satellites can be added to the still images and movies you shoot, or this information can be logged separately. In addition to geotagging, the camera clock can be updated automatically. Before using GPS functions, make sure the date, time, and home time zone on the camera are set correctly, as described in “Setting the Date and Time” (📖15).



- When using GPS functions, keep the following points in mind.
- In certain countries and regions, the use of GPS may be restricted. Therefore, be sure to use GPS in accordance with the laws and regulations of your country or region. Be particularly careful when using GPS outside your home country.
  - Be careful about using GPS features where the operation of electronic devices is restricted, because the camera will receive GPS signals.
  - Others may be able to locate or identify you by using location data in your geotagged still images or movies. Be careful when sharing these images or GPS log files with others, as when posting images online where many others can view them.



- GPS: Global Positioning System

## Where to Use GPS, and How to Hold the Camera

GPS Antenna

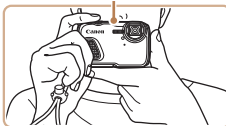

- Use the camera outside, where there is an unobstructed view of the sky. (GPS functions will not work correctly indoors or in other areas away from GPS coverage (📖29).)
- Hold the camera correctly, as shown, for easier GPS signal reception.
- Keep your fingers or other objects off the GPS antenna.

## How to Carry the Camera When Using the Logger Function

For better GPS signal reception, try to keep the GPS antenna pointing up, toward the sky. When carrying the camera in a bag, put it in the bag with the GPS antenna pointing up, and try to put the camera in an outer section of bag.

## Places with Poor GPS Coverage

- Location information may not be recorded, or inaccurate information may be recorded where GPS signal coverage is poor, such as in the following places.
  - Indoors
  - underground
  - near buildings or in valleys
  - in tunnels or forests
  - near high-voltage power lines or mobile phones operating on the 1.5 GHz band
  - inside a bag or suitcase
  - under water
  - when traveling across great distances
  - when traveling through different environments
- Even in other places, GPS satellite movement may interfere with geotagging and cause missing or inaccurate location information, or the information may indicate that the camera has been used elsewhere even if it has not.

Before Use

Basic Guide

Advanced Guide

Camera Basics

Using GPS Functions

Auto Mode

Other Shooting Modes

P Mode

Playback Mode

Setting Menu

Accessories

Appendix

Index



## Time Required to Receive a GPS Signal

- GPS signal reception may take longer after battery replacement, or when you have not used GPS functions for some time.

## Using GPS Functions



### 1 Configure the setting.

- Press the button, choose in the menu, and choose (📖25).
- To restore the original setting, repeat this process but choose .

### 2 Check the reception status.

- Use the camera outside, where there is an unobstructed view of the sky. (GPS functions will not work correctly indoors or in other areas away from GPS coverage (📖29).)
- Check GPS reception status as shown on the screen.



- You can also configure GPS settings in MENU (📖26).

## Reception Status Display

(on)	GPS signal received. Location can be recorded. *
(blinking)	Looking for GPS signal. *
(on)	No GPS signal.

\* When you have activated the logger (📖31), is also displayed.

## Tips When is Displayed

- When GPS signal reception is not possible indoors or in other places away from coverage (📖29), try going outside where there is an unobstructed view of the sky. Hold the camera correctly (📖29) and point the GPS antenna up at the sky.
- will normally be displayed within a few minutes when the camera is used in areas with ample GPS coverage, such as outdoor areas with an unobstructed view of the sky. If is not displayed, move to an area without obstructions (such as buildings) between the camera and GPS satellites and wait a few minutes until it appears.

## Geotagging Images while Shooting

The still images and movies you shoot can be geotagged, automatically adding latitude, longitude, and elevation information. You can review the recorded location information on the camera (📖82). Using the software (📖119), you can also view the locations on a map, with the still images and movies shown next to them.

### 1 Activate GPS.

- Follow steps 1 – 2 in “Using GPS Functions” (📖30) to configure the setting.

### 2 Shoot.

- The still images and movies you shoot are now geotagged, and you can review the location information as described in “GPS Information Display” (📖82).

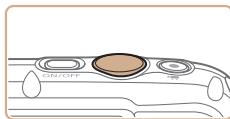

- In addition to geotagging your shots, you can also tag shots with the shooting date and time (📖82) in UTC format (📖33).

Before Use

Basic Guide

Advanced Guide

Camera Basics

Using GPS Functions

Auto Mode

Other Shooting Modes

P Mode

Playback Mode

Setting Menu

Accessories

Appendix

Index





- Geotagging applies the initial camera location and shooting date and time, as acquired when you begin shooting a movie.
- For movies made using [4K] mode (📖30), geotagging applies the initial camera location and shooting date and time, as acquired for the first clip shot that day.

## Logging Camera Location Data

You can keep a record of where the camera was taken by using location information acquired from GPS satellite signals over a period of time. Daily location and time data is logged to a file, separate from image data. Log files can be reviewed on the camera (📖32), and with the software (📖119), you can use log files to follow the route taken with the camera on a map.

Note that the GPS logger will reduce battery life, because some power is consumed even when the camera is off. Charge the battery pack as needed, or keep a spare charged battery pack with you.



### 1 Configure the setting.

- Follow step 1 in “Using GPS Functions” (📖30) to choose [📶], press the <MENU> button, and then press the <<>> buttons to choose [On].
- To restore the original setting, repeat this process but choose [Off].



### 2 Finish the setup process.

- When you press the <FUNC/SEL> button, a message about the logger is displayed. Be sure to read the message.
- The [📶] icon shown with your shots indicates the GPS reception status at that time (📖30).
- The logger function will operate, and the date, time and location information based on signals acquired from GPS satellites will be logged to the camera.
- The logger will continue to function even when the camera is turned off.

### 3 Save the GPS log files to the memory card.

- When you turn off the camera, a message about the logger is displayed. The location information, date and time will be saved to the memory card. This information will not remain on the camera.
- The location information, date and time will be saved to the memory card when you do any of the following things.
  - Display the log files
  - Display the date/time setting screen
  - Display the time zone setting screen
- If the camera is off and you want to remove the memory card when the logger is being used, turn the camera on, then turn it off again before removing the memory card.

Before Use

Basic Guide

Advanced Guide

Camera Basics

Using GPS Functions

Auto Mode

Other Shooting Modes

P Mode

Playback Mode

Setting Menu

Accessories

Appendix

Index





- Removing the battery pack after step 3 will deactivate the logger. To reactivate the logger after battery replacement, turn the camera on and then off again.
- Saving GPS log files is not possible when the memory card write-protect tab is in the locked position. Make sure the tab is set to the unlocked side.
- Location information, date and time will be saved to the memory card when the camera is turned off or when displaying log files (📖32). For this reason, if the camera is off and you want to remove the memory card when the logger is being used, turn the camera on, then turn it off again before removing the memory card.
- When using the logger function, exercise caution when turning the camera over to another person, as the date and time, and logged location information will remain on the camera until it is saved to a memory card (even if the battery pack runs out of power).
- Be careful when formatting memory cards (📖106), because the GPS log file will also be erased.



- You can also configure logger settings in MENU (📖109).

## Checking the GPS Log Files

You can check the GPS log files saved to a memory card on the camera.

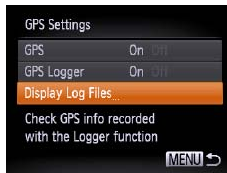

### 1 Access the [GPS Settings] screen.

- Press the <MENU> button, choose [GPS Settings] on the [↑↓] tab, and then press the <FUNC/SET> button (📖26).

### 2 Access the [Display Log Files] screen.

- Choose [Display Log Files], and then press the <FUNC/SET> button (📖26).

Before Use

Basic Guide

Advanced Guide

Camera Basics

Using GPS Functions

Auto Mode

Other Shooting Modes

P Mode

Playback Mode

Setting Menu

Accessories

Appendix

Index







Number of Logs Acquired



Latitude Longitude Time

### 3 Choose the log file to examine.

- To the right of today's date, the time elapsed from the last time location information was recorded is displayed.
- Choose the desired date and press the button. The recorded latitude, longitude, time, and number of logs acquired that day are displayed.
- Press the **<MENU>** button twice to return to the [GPS Settings] screen. When you press the **<MENU>** button again, a message about GPS and logging is displayed. Press the button after reading the message.

## Automatically Updating the Date and Time

You can have the date and time for the configured time zone ( 15, 109) automatically updated when the camera receives GPS signals. Your shots will be tagged with the shooting date/time as updated ( 82, in UTC format), along with location information ( 30).

### 1 Set [GPS] to [On].

- Follow steps 1 – 2 in “Using GPS Functions” ( 30) to configure the setting.

### 2 Configure the setting.

- Press the **<MENU>** button, choose [GPS Auto Time] on the , and then choose [On] ( 26).
- To set daylight saving time, follow the steps in “Setting the Date and Time” ( 16).

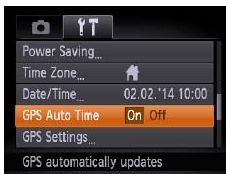

### Confirming Automatic Time Updating

After the date and time are automatically updated, [Update completed] is shown on the [Date/Time] screen, accessed as described in “Changing the Date and Time” ( 16). [GPS Auto Time: On] is shown if a GPS signal has not been received yet.

- When [GPS Auto Time] is set to [On], you cannot change the date and time by accessing the [Date/Time] screen as described in “Changing the Date and Time” ( 16), because this information will be updated automatically.

Before Use

Basic Guide

Advanced Guide

Camera Basics

Using GPS Functions

Auto Mode

Other Shooting Modes

P Mode

Playback Mode

Setting Menu

Accessories

Appendix

Index



# Auto Mode

Convenient mode for easy shots with greater control over shooting

## Shooting with Camera-Determined

<b>Settings</b> .....	<b>35</b>
Shooting (Smart Auto).....	35
Scene Icons .....	38
Image Stabilization Icons .....	39
On-Screen Frames.....	39

## Common, Convenient Features .....

<b>40</b>	
Zooming In Closer on Subjects (Digital Zoom) .....	40
Using the Self-Timer.....	40
Deactivating the Flash.....	42
Adding a Date Stamp.....	42

## Image Customization Features .....

<b>43</b>	
Changing the Aspect Ratio.....	43
Changing Image Resolution (Size) .....	44
Red-Eye Correction.....	44
Changing Movie Image Quality .....	45
Using the Wind Filter.....	45

## Helpful Shooting Features .....

<b>46</b>	
Displaying Grid Lines .....	46
Magnifying the Area in Focus.....	46
Checking for Closed Eyes.....	47

## Customizing Camera Operation .....

<b>47</b>	
Deactivating the AF-Assist Beam.....	47
Deactivating the Red-Eye Reduction Lamp .....	48
Changing the Image Display Period after Shots ...	48
Changing the Image Display Style after Shots.....	49

Before Use

Basic Guide

Advanced Guide

Camera Basics

Using GPS  
Functions

Auto Mode

Other Shooting  
Modes

P Mode

Playback Mode

Setting Menu

Accessories

Appendix

Index



## Shooting with Camera-Determined Settings

For fully automatic selection of the optimal settings for specific scenes, simply let the camera determine the subject and shooting conditions.

Still Images

Movies

### Shooting (Smart Auto)

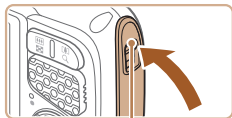

Red Mark

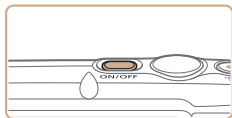
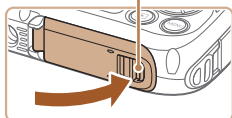

#### 1 Make sure the covers are closed.

- Make sure that both the memory card/battery cover lock and terminal lock return to the positions shown, with the red marks no longer visible.
- If either cover is not fully closed, water may enter the camera when it gets wet, which may damage it.

#### 2 Turn the camera on.

- Press the power button.
- The startup screen is displayed.

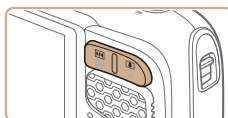

Zoom Bar



#### 3 Enter [AUTO] mode.

- Press the <▲> button, press the <▲><▼> buttons to choose [AUTO], and then press the <FUNC SET> button.
- Icons representing the scene and image stabilization mode are displayed in the upper right of the screen (📖 38, 39).
- Frames displayed around any detected subjects indicate that they are in focus.

#### 4 Compose the shot.

- To zoom in and enlarge the subject, press the <📷> (telephoto) zoom button, and to zoom away from the subject, press the <📷> (wide angle) zoom button. (A zoom bar showing the zoom position is displayed.)

Before Use

Basic Guide

Advanced Guide

Camera Basics

Using GPS Functions

Auto Mode

Other Shooting Modes

P Mode

Playback Mode

Setting Menu

Accessories

Appendix

Index



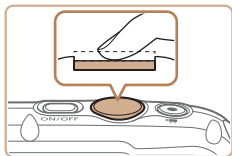

## 5 Shoot.

### Shooting Still Images

#### ① Focus.

- Press the shutter button halfway. The camera beeps twice after focusing, and AF frames are displayed to indicate image areas in focus.
- Several AF frames are displayed when multiple areas are in focus.

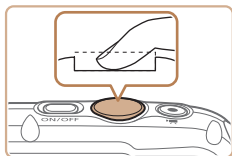
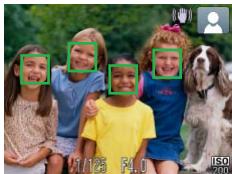

#### ② Shoot.

- Press the shutter button all the way down.
- As the camera shoots, a shutter sound is played, and in low-light conditions, the flash fires automatically.
- Your shot remains displayed on the screen for about two seconds.
- Even while the shot is displayed, you can take another shot by pressing the shutter button again.

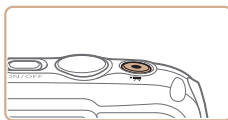

Elapsed Time



## Shooting Movies

### ① Start shooting.

- Press the movie button. The camera beeps once as recording begins, and [●Rec] is displayed with the elapsed time.
- Black bars displayed on the top and bottom edges of the screen indicate image areas not recorded.
- Once recording begins, take your finger off the movie button.

Before Use

Basic Guide

Advanced Guide

Camera Basics

Using GPS  
Functions

Auto Mode

Other Shooting  
Modes

P Mode

Playback Mode

Setting Menu

Accessories

Appendix

Index



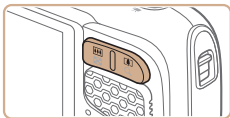

## ② Resize the subject and recompose the shot as needed.

- To resize the subject, repeat the operations in step 4 (📖35). However, note that the sound of camera operations will be recorded. Note that movies shot at zoom factors shown in blue will look grainy.
- When you recompose shots, the focus, brightness, and colors will be automatically adjusted.

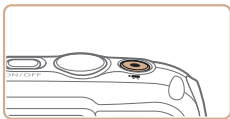

## ③ Finish shooting.

- Press the movie button again to stop shooting. The camera beeps twice as recording stops.
- Recording will stop automatically when the memory card becomes full.

## ■ Still Images/Movies

- ! If the camera is turned on while the <▼> button is held down, the camera will no longer sound. To activate sounds again, press the <MENU> button and choose [Mute] on the [🔑] tab, and then press the <◀><▶> buttons to choose [Off].

## ■ Still Images

- ! A blinking [📷] icon warns that images are more likely to be blurred by camera shake. In this case, mount the camera on a tripod or take other measures to keep it still.
- If your shots are dark despite the flash firing, move closer to the subject. For details on the flash range, see “Flash Range” (📖148).
- The subject may be too close if the camera only beeps once when you press the shutter button halfway. For details on the focusing range (shooting range), see “Shooting Range” (📖148).
- To reduce red-eye and to assist in focusing, the lamp may be activated when shooting in low-light conditions.
- A blinking [🔋] icon displayed when you attempt to shoot indicates that shooting is not possible until the flash has finished recharging. Shooting can resume as soon as the flash is ready, so either press the shutter button all the way down and wait, or release it and press it again.



- You can change how long images are displayed after shots (📖48).

Before Use

Basic Guide

Advanced Guide

Camera Basics

Using GPS  
Functions

Auto Mode

Other Shooting  
Modes

P Mode

Playback Mode

Setting Menu

Accessories

Appendix

Index



## Movies



- The camera may become warm when shooting movies repeatedly over an extended period. This does not indicate damage.

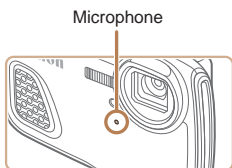

- Keep your fingers away from the microphone while shooting movies. Blocking the microphone may prevent audio from being recorded or may cause the recording to sound muffled.
- Avoid touching camera controls other than the movie button when shooting movies, because sounds made by the camera will be recorded.

- To correct suboptimal image color that may occur in [M20] movie shooting (45) after you recompose shots, press the movie button to stop recording, and then press it again to resume recording.



- Audio recording is monaural.

Still Images

Movies

## Scene Icons

In [AUTO] mode, shooting scenes determined by the camera are indicated by the icon displayed, and corresponding settings are automatically selected for optimal focusing, subject brightness, and color.

Background	Subject	People		Other Subjects			Icon Background Color
		In Motion*1	Shadows on Face*1		In Motion*1	At Close Range	
Bright				AUTO			Gray
Backlit			–				
With Blue Sky				AUTO			Light Blue
Backlit			–				
Sunsets	–				–		Orange
Spotlights							Dark Blue
Dark			AUTO				
Tripod Used	*2	–		*2	–		

\*1 Not displayed for movies.

\*2 Displayed in dark scenes when the camera is held still, as when mounted on a tripod.



- Try shooting in [P] mode (66) if the scene icon does not match actual shooting conditions, or if it is not possible to shoot with your expected effect, color, or brightness.

Before Use

Basic Guide

Advanced Guide

Camera Basics

Using GPS Functions

Auto Mode

Other Shooting Modes

P Mode

Playback Mode

Setting Menu

Accessories







Appendix

Index



## Image Stabilization Icons

Optimal image stabilization for the shooting conditions is automatically applied (Intelligent IS). Additionally, the following icons are displayed in **[AUTO]** mode.

	Image stabilization for still images		Image stabilization for movies, reducing strong camera shake, as when shooting while walking (Dynamic IS)
	Image stabilization for still images when panning*		Image stabilization for slow camera shake, such as when shooting movies at telephoto (Powered IS)
	Image stabilization for macro shots (Hybrid IS)		No image stabilization, because the camera is mounted on a tripod or held still by other means

\* Displayed when you pan, following moving subjects with the camera. When you follow subjects moving horizontally, image stabilization only counteracts vertical camera shake, and horizontal stabilization stops. Similarly, when you follow subjects moving vertically, image stabilization only counteracts horizontal camera shake.



- To cancel image stabilization, set [IS Mode] to [Off] (📖78). In this case, an IS icon is not displayed.

## On-Screen Frames

A variety of frames are displayed once the camera detects subjects you are aiming the camera at.

- A white frame is displayed around the subject (or person's face) determined by the camera to be the main subject, and gray frames are displayed around other detected faces. Frames follow moving subjects within a certain range to keep them in focus. However, if the camera detects subject movement, only the white frame will remain on the screen.
- When you are pressing the shutter button halfway and the camera detects subject movement, a blue frame is displayed, and the focus and image brightness are constantly adjusted (Servo AF).



- Try shooting in **[P]** mode (📖66) if no frames are displayed, if frames are not displayed around desired subjects, or if frames are displayed on the background or similar areas.



## Common, Convenient Features

Still Images

Movies

### Zooming In Closer on Subjects (Digital Zoom)

When distant subjects are too far away to enlarge using the optical zoom, use digital zoom for up to about 20x enlargement.

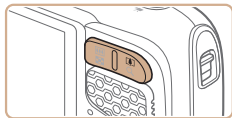

#### 1 Press the zoom button.

- Hold the button until zooming stops.
- Zooming stops at the largest possible zoom factor (before the image becomes grainy), which is displayed when you release the zoom button.

#### 2 Press the zoom button again.

- The camera zooms in even closer on the subject, using digital zoom.

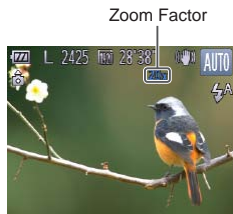

- Zoomed images may look grainy under some resolution settings (see page 44) and zoom factors. In this case, the zoom factor is shown in blue.



- To deactivate digital zoom, choose MENU (see page 26) > [Camera] tab > [Digital Zoom] > [Off] (see page 26).

Still Images





Movies

### Using the Self-Timer

With the self-timer, you can include yourself in group photos or other timed shots. The camera will shoot about 10 seconds after you press the shutter button.



#### 1 Configure the setting.

- Press the  button, choose  in the menu, and then choose the  option (see page 25).
- Once the setting is complete,  is displayed.

#### 2 Shoot.

- For Still Images: Press the shutter button halfway to focus on the subject, and then press it all the way down.
- For Movies: Press the movie button.

Before Use

Basic Guide

Advanced Guide

Camera Basics

Using GPS Functions

Auto Mode

Other Shooting Modes

P Mode

Playback Mode

Setting Menu

Accessories

Appendix

Index





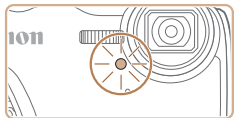

- Once you start the self-timer, the lamp will blink and the camera will play a self-timer sound.
- Two seconds before the shot, the blinking and sound will speed up. (The lamp will remain lit in case the flash fires.)
- To cancel shooting after you have triggered the self-timer, press the <MENU> button.
- To restore the original setting, choose [C<sub>OFF</sub>] in step 1.

Still Images

Movies

## Using the Self-Timer to Avoid Camera Shake

This option delays shutter release until about two seconds after you have pressed the shutter button. If the camera is unsteady while you are pressing the shutter button, it will not affect your shot.

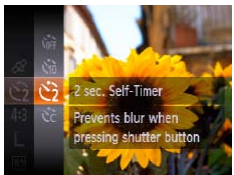

- Follow step 1 in “Using the Self-Timer” (40) and choose [C<sub>2</sub>].
- Once the setting is complete, [C<sub>2</sub>] is displayed.
- Follow step 2 in “Using the Self-Timer” (40) to shoot.

## Customizing the Self-Timer

You can specify the delay (0 – 30 seconds) and number of shots (1 – 10).

Still Images

Movies

### 1 Choose [C<sub>2</sub>].

- Following step 1 in “Using the Self-Timer” (40), choose [C<sub>2</sub>] and press the <MENU> button.

### 2 Configure the setting.

- Press the <▲><▼> buttons to choose [Delay] or [Shots].
- Press the <◀><▶> buttons to choose a value, and then press the [FUNC SET] button.
- Once the setting is complete, [C<sub>2</sub>] is displayed.
- Follow step 2 in “Using the Self-Timer” (40) to shoot.



- For movies shot using the self-timer, [Delay] represents the delay before recording begins, but the [Shots] setting has no effect.



- When you specify multiple shots, image brightness and white balance are determined by the first shot. More time is required between shots when the flash fires or when you have specified to take many shots. Shooting will stop automatically when the memory card becomes full.
- When a delay longer than two seconds is specified, two seconds before the shot, the lamp blinking and self-timer sound will speed up. (The lamp will remain lit in case the flash fires.)

Before Use

Basic Guide

Advanced Guide

Camera Basics

Using GPS Functions

Auto Mode

Other Shooting Modes

P Mode

Playback Mode

Setting Menu

Accessories

Appendix

Index



## Deactivating the Flash

Prepare the camera for shooting without the flash as follows.



- Press the <▶> button, press the <<▶><<▶> buttons to choose [MENU SET], and then press the <MENU SET> button.
- Once the setting is complete, [MENU SET] is displayed.
- To restore the original setting, repeat this process but choose [FLASH].



- If a blinking [MENU SET] icon is displayed when you press the shutter button halfway in camera-shake inducing, low-light conditions, mount the camera on a tripod or take other measures to keep it still.

## Adding a Date Stamp

The camera can add the shooting date to images, in the lower-right corner. However, note that date stamps cannot be edited or removed, so confirm beforehand that the date and time are correct (📖15).

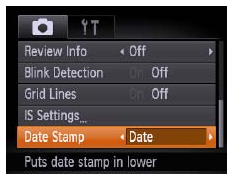

### 1 Configure the setting.

- Press the <MENU> button, choose [Date Stamp] on the [CAMERA] tab, and then choose the desired option (📖26).
- Once the setting is complete, [DATE] is displayed.

### 2 Shoot.

- As you take shots, the camera adds the shooting date or time to the lower-right corner of images.
- To restore the original setting, choose [Off] in step 1.

- Date stamps cannot be edited or removed.





- Shots taken without adding a date stamp can be printed with one as follows. However, adding a date stamp this way to images that already have one may cause it to be printed twice.
  - Print using printer functions (📖122)
  - Use camera DPOF print settings (📖126) to print
  - Use the software downloaded from the Canon website (📖119) to print

## Image Customization Features

Still Images

### Changing the Aspect Ratio

Change the image aspect ratio (ratio of width to height) as follows.



- Press the button, choose **[4:3]** in the menu, and choose the desired option (📖25).
- Once the setting is complete, the screen aspect ratio will be updated.
- To restore the original setting, repeat this process but choose **[4:3]**.

<b>16:9</b>	Used for display on widescreen HDTVs or similar display devices.
<b>3:2</b>	Same aspect ratio as 35mm film, used for printing images at 5 x 7-inch or postcard sizes.
<b>4:3</b>	Native aspect ratio of the camera screen, also used for display on standard-definition televisions or similar display devices, or for printing images at 3.5 x 5-inch or A-series sizes.
<b>1:1</b>	Square aspect ratio.



- At aspect ratios other than **[4:3]**, digital zoom (📖40) is not available ([Digital Zoom] is set to [Off]).

Before Use

Basic Guide

Advanced Guide

Camera Basics

Using GPS Functions

Auto Mode

Other Shooting Modes

P Mode

Playback Mode

Setting Menu

Accessories

Appendix

Index



## Changing Image Resolution (Size)

Choose from 4 levels of image resolution, as follows. For guidelines on how many shots at each resolution setting can fit on a memory card, see “Number of 4:3 Shots per Memory Card” (📖148).



- Press the <FUNC. SET> button, choose [L] in the menu, and choose the desired option (📖25).
- The option you configured is now displayed.
- To restore the original setting, repeat this process but choose [L].

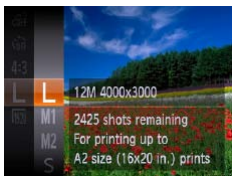

## Guidelines for Choosing Resolution Based on Paper Size (for 4:3 Images)

A2 (16.5 x 23.4 in.)

L

A3 – A5 (11.7 x 16.5  
– 5.8 x 8.3 in.)

M1

5 x 7 in.  
Postcard  
3.5 x 5 in.

M2

- [S]: For e-mailing images.

## Red-Eye Correction

Red-eye that occurs in flash photography can be automatically corrected as follows.

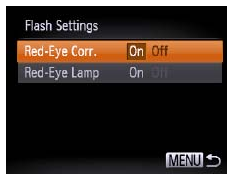
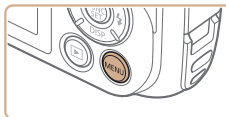

### 1 Access the [Flash Settings] screen.

- Press the <MENU> button, choose [Flash Settings] on the [📷] tab, and then press the <FUNC. SET> button (📖26).

### 2 Configure the setting.

- Choose [Red-Eye Corr.], and then choose [On] (📖26).
- Once the setting is complete, [📷] is displayed.
- To restore the original setting, repeat this process but choose [Off].



- Red-eye correction may be applied to image areas other than eyes (if the camera misinterprets red eye makeup as red pupils, for example).



- You can also correct existing images (📖100).
- You can also access the screen in step 2 by pressing the <▶> button and then the <MENU> button.



## Changing Movie Image Quality

3 image quality settings are available. For guidelines on the maximum movie length at each level of image quality that will fit on a memory card, see “Recording Time per Memory Card” (📖148).



- Press the <FUNC SET> button, choose [1920] in the menu, and choose the desired option (📖25).
- The option you configured is now displayed.
- To restore the original setting, repeat this process but choose [1920].



Image Quality	Resolution	Frame Rate	Details
1920	1920 x 1080	24 fps	For shooting in Full HD
1280	1280 x 720	30 fps	For shooting in HD
640	640 x 480	30 fps	For shooting in standard definition



- In [1920] and [1280] modes, black bars displayed on the top and bottom edges of the screen indicate image areas not recorded.

## Using the Wind Filter

Distorted audio caused by recording when the wind is strong can be reduced. However, the recording may sound unnatural when this option is used when there is no wind.

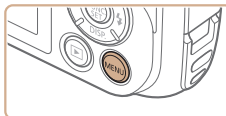

- Press the <MENU> button, choose [Wind Filter] on the [📷] tab, and then choose [On] (📖26).
- To restore the original setting, repeat this process but choose [Off].



# Helpful Shooting Features

Still Images

Movies

## Displaying Grid Lines

Grid lines can be displayed on the screen for vertical and horizontal reference while shooting.

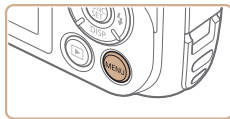

- Press the <MENU> button, choose [Grid Lines] on the [📷] tab, and then choose [On] (📖26).
- Once the setting is complete, grid lines are displayed on the screen.
- To restore the original setting, repeat this process but choose [Off].

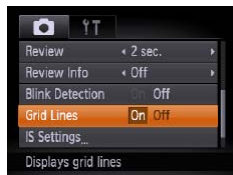

- Grid lines are not recorded in your shots.

Still Images

## Magnifying the Area in Focus

You can check the focus by pressing the shutter button halfway, which will enlarge the portion of the image in focus in the AF frame.

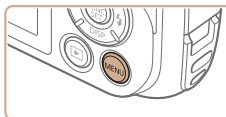

### 1 Configure the setting.

- Press the <MENU> button, choose [AF-Point Zoom] on the [📷] tab, and then choose [On] (📖26).

### 2 Check the focus.

- Press the shutter button halfway. The face detected as the main subject is now magnified.
- To restore the original setting, choose [Off] in step 1.



- The area in focus will not be magnified when you press the shutter button halfway if a face was not detected, if the person is too close to the camera and their face is too large for the screen, or if the camera detects subject movement.

Before Use

Basic Guide

Advanced Guide

Camera Basics

Using GPS Functions

Auto Mode

Other Shooting Modes

P Mode

Playback Mode

Setting Menu

Accessories

Appendix

Index





- The area in focus is not magnified in the following cases when the shutter button is pressed halfway.
  - When digital zoom is used (📖40)
  - When Tracking AF is used (📖75)
  - When a TV is used as a display (📖115)

Still Images

## Checking for Closed Eyes

is displayed when the camera detects that people may have closed their eyes.

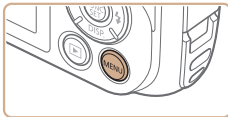

### 1 Configure the setting.

- Press the <MENU> button, choose [Blink Detection] on the [📷] tab, and then choose [On] (📖26).



### 2 Shoot.

- flashes when the camera detects a person whose eyes are closed.
- To restore the original setting, choose [Off] in step 1.



- When you have specified multiple shots in [📷] mode, this function is only available for the final shot.

## Customizing Camera Operation

Customize shooting functions on the MENU [📷] tab as follows. For instructions on menu functions, see “Using Menus” (📖26).

Still Images

### Deactivating the AF-Assist Beam

You can deactivate the lamp that normally lights up to help you focus when you press the shutter button halfway in low-light conditions.



- Press the <MENU> button, choose [AF-assist Beam] on the [📷] tab, and then choose [Off] (📖26).
- To restore the original setting, repeat this process but choose [On].

Before Use

Basic Guide

Advanced Guide

Camera Basics

Using GPS Functions

Auto Mode

Other Shooting Modes

P Mode

Playback Mode

Setting Menu

Accessories

Appendix

Index



## Deactivating the Red-Eye Reduction Lamp

You can deactivate the red-eye reduction lamp that lights up to reduce red-eye when the flash is used in low-light shots.

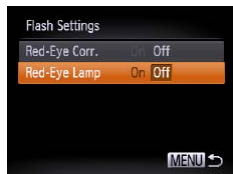

### 1 Access the [Flash Settings] screen.

- Press the <MENU> button, choose [Flash Settings] on the [CAMERA] tab, and then press the <FUNC/SET> button (📖26).

### 2 Configure the setting.

- Choose [Red-Eye Lamp], and then choose [Off] (📖26).
- To restore the original setting, repeat this process but choose [On].

## Changing the Image Display Period after Shots

Change how long images are displayed after shots as follows.



### Configure the setting.

- Press the <MENU> button, choose [Review] on the [CAMERA] tab, and then choose the desired option (📖26).
- To restore the original setting, repeat this process but choose [2 sec.].

2 – 10 sec.	Displays images for the specified time.
Hold	Displays images until you press the shutter button halfway.
Off	No image display after shots.





## Changing the Image Display Style after Shots

Change the way images are displayed after shots as follows.



### Configure the setting.

- Press the <MENU> button, choose [Review Info] on the [CAMERA] tab, and then choose the desired option (📖26).
- To restore the original setting, repeat this process but choose [Off].

Off	Displays only the image.
Detailed	Displays shooting details (📖138).
Focus Check	Shows the area in the AF frame magnified, enabling you to check the focus. Follow the steps in "Checking the Focus" (📖83).

Before Use

Basic Guide

Advanced Guide

Camera Basics

Using GPS  
Functions

Auto Mode

Other Shooting  
Modes

P Mode

Playback Mode

Setting Menu

Accessories

Appendix

Index



# Other Shooting Modes

Shoot more effectively in various scenes, and take shots enhanced with unique image effects or captured using special functions

<b>Specific Scenes</b> .....	<b>51</b>	<b>Special Modes for Other Purposes</b> .....	<b>59</b>
<b>Applying Special Effects</b> .....	<b>54</b>	Auto Clip Recording (Movie Digest) .....	59
Shooting with a Fish-Eye Lens Effect (Fish-Eye Effect) .....	54	Auto Shooting after Face Detection (Smart Shutter).....	60
Shots Resembling Miniature Models (Miniature Effect).....	55	Shooting Long Exposures (Long Shutter).....	62
Shooting with a Toy Camera Effect (Toy Camera Effect) .....	56	Shooting Stitch Assist Images.....	63
Shooting in Monochrome .....	56	<b>Shooting Various Movies</b> .....	<b>64</b>
Shooting with Color Accent .....	57	Shooting iFrame Movies .....	64
Shooting with Color Swap.....	58	Shooting Super Slow Motion Movies .....	64

Before Use

Basic Guide

Advanced Guide

Camera Basics

Using GPS  
Functions

Auto Mode

Other Shooting  
Modes

P Mode

Playback Mode

Setting Menu

Accessories

Appendix

Index



## Specific Scenes

Choose a mode matching the shooting scene, and the camera will automatically configure the settings for optimal shots.



### 1 Choose a shooting mode.

- Press the <▲> button, and then press the <▲><▼> buttons to choose a shooting mode.
- When multiple icons are displayed in the middle of the screen, press the <◀><▶> buttons to choose a shooting mode.
- Press the <FUNC/SET> button.

### 2 Shoot.



Still Images

Movies

### Shoot underwater (Underwater)

- Take natural-colored shots of sea life and underwater scenery.
- This mode can correct white balance and match the effect of using a commercially available color-compensating filter (p.53).



Still Images

Movies

### Shoot close-up subjects under water (Underwater Macro)

- Take natural-colored, close-up shots of sea life. Use the digital zoom to get even closer shots of subjects.

However, use of digital zoom may cause images to appear grainy at some resolutions (p.44).

Still Images

Movies

### Shoot with snowy backgrounds (Snow)

- Bright, natural-colored shots of people against snowy backgrounds.



Still Images

Movies

### Shoot portraits (Portrait)

- Take shots of people with a softening effect.



Before Use

Basic Guide

Advanced Guide

Camera Basics

Using GPS Functions

Auto Mode

Other Shooting Modes

P Mode

Playback Mode

Setting Menu

Accessories

Appendix

Index



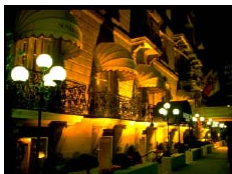

Still Images

### Shoot evening scenes without using a tripod (Handheld NightScene)

- Beautiful shots of evening scenes without the need to hold the camera very still, as with a tripod.
- A single image is created by combining consecutive shots, reducing camera shake and image noise.



Still Images

### Shoot under low light (Low Light)

- Shoot with minimal camera and subject shake even in low-light conditions.









Still Images

Movies





### Shoot fireworks (Fireworks)

- Vivid shots of fireworks.



- In  mode, shots may look grainy because the ISO speed (69) is increased to suit the shooting conditions.
- Because the camera will shoot continuously in  mode, hold it steady while shooting.
- In  mode, excessive motion blur or certain shooting conditions may prevent you from obtaining the desired results.
- In  mode, mount the camera on a tripod or take other measures to keep it still and prevent camera shake. Additionally, you should set [IS Mode] to [Off] when using a tripod or other means to secure the camera (78).



- When you use a tripod for evening scenes, shooting in  mode instead of  mode will give better results (35).
-  mode resolution is [M] (1984 x 1488) and cannot be changed.
- In  mode, optical zoom is set to maximum wide angle and cannot be used.

Before Use

Basic Guide

Advanced Guide

Camera Basics

Using GPS Functions

Auto Mode

Other Shooting Modes

P Mode

Playback Mode

Setting Menu

Accessories

Appendix

Index



## Shooting Quickly Underwater

To avoid missing unexpected underwater shooting opportunities with subjects about 3 m (9.8 ft.) away from you, try switching to [i] mode (51) and setting the focusing range to [MF]. These settings are especially effective when shooting subjects that are moving around.

### 1 Choose [i].

- Follow step 1 in “Specific Scenes” (51) and choose [i].

### 2 Choose the focusing range.

- Press the <> button, press the <<>> buttons to choose [MF], and then press the <FUNC SET> button.

### 3 Shoot.

- Aim the camera so that the subject is in the center frame, and then press the shutter button halfway.
- As soon as you notice a good shooting opportunity, press the shutter button all the way down.



- For closer subjects that are not in sharp focus, try setting the focusing range to [AF].



- The AF frame will remain white while the shutter button is pressed halfway.
- These settings are not available when using Tracking AF (75).



## Correcting White Balance

White balance can be manually corrected in [i] and [s] modes (51). This adjustment can match the effect of using a commercially available color-compensating filter.

### 1 Choose [i] or [s].

- Follow steps 1 – 2 in “Specific Scenes” (51) and choose [i] or [s].

### 2 Choose white balance.

- Press the <FUNC SET> button, choose [AWB] in the menu, and press the <FUNC SET> button again.



### 3 Adjust the setting.

- Press the zoom buttons to adjust the correction level for B and A, and then press the <FUNC SET> button.
- Once the setting is complete, [WB] is displayed.



- The camera will retain white balance correction levels even if you switch to another white balance option in step 2, but correction levels will be reset if you record custom white balance data.



- B represents blue and A, amber.
- White balance can also be manually corrected by recording custom white balance data (70) before following the preceding steps.



## Applying Special Effects

Add a variety of effects to images when shooting.

### 1 Choose a shooting mode.

- Follow step 1 in “Specific Scenes” (p.51) to choose a shooting mode.

### 2 Shoot.



Still Images

Movies

### Shoot in vivid colors (Super Vivid)

- Shots in rich, vivid colors.





Still Images

Movies

### Posterized shots (Poster Effect)

- Shots that resemble an old poster or illustration.

- ! In [] and [] modes, try taking some test shots first, to make sure you obtain the desired results.

Still Images

## Shooting with a Fish-Eye Lens Effect (Fish-Eye Effect)

Shoot with the distorting effect of a fish-eye lens.

### 1 Choose [].

- Follow step 1 in “Specific Scenes” (p.51) and choose [].

### 2 Choose an effect level.

- Press the <▼> button, press the <◀▶> buttons to choose an effect level, and then press the <FUNC SET> button.
- A preview is shown of how your shot will look with the effect applied.

### 3 Shoot.



- ! Try taking some test shots first, to make sure you obtain the desired results.

Before Use

Basic Guide

Advanced Guide

Camera Basics

Using GPS Functions

Auto Mode

Other Shooting Modes

P Mode

Playback Mode

Setting Menu

Accessories

Appendix

Index



## Shots Resembling Miniature Models (Miniature Effect)

Creates the effect of a miniature model, by blurring image areas above and below your selected area.

You can also make movies that look like scenes in miniature models by choosing the playback speed before the movie is recorded. People and objects in the scene will move quickly during playback. Note that sound is not recorded.

### 1 Choose [F].

- Follow step 1 in “Specific Scenes” (p. 51) and choose [F].
- A white frame is displayed, indicating the image area that will not be blurred.

### 2 Choose the area to keep in focus.

- Press the <▼> button.
- Press a zoom button to resize the frame, and press the <▲><▼> buttons to move it.



### 3 For movies, choose the movie playback speed.

- Press the <MENU> button, and then press the <◀><▶> buttons to choose the speed.

### 4 Return to the shooting screen and shoot.

- Press the <MENU> button to return to the shooting screen, and then shoot.

## Playback Speed and Estimated Playback Time (for One-Minute Clips)

Speed	Playback Time
5x	Approx. 12 sec.
10x	Approx. 6 sec.
20x	Approx. 3 sec.

- The zoom is not available when shooting movies. Be sure to set the zoom before shooting.
- Try taking some test shots first, to make sure you obtain the desired results.



- To switch the orientation of the frame to vertical, press the <◀><▶> buttons in step 2. To move the frame, press the <◀><▶> buttons again. To return the frame to horizontal orientation, press the <▲><▼> buttons.
- Holding the camera vertically will change the orientation of the frame.
- Movie image quality is [640] at an aspect ratio of [4:3] and [1280] at an aspect ratio of [16:9] (p. 43). These quality settings cannot be changed.



## Shooting with a Toy Camera Effect (Toy Camera Effect)

This effect makes images resemble shots from a toy camera by vignetting (darker, blurred image corners) and changing the overall color.

### 1 Choose [📷].

- Follow step 1 in “Specific Scenes” (📖51) and choose [📷].

### 2 Choose a color tone.

- Press the <▼> button, press the <◀><▶> buttons to choose a color tone, and then press the <FUNC SET> button.
- A preview is shown of how your shot will look with the effect applied.

### 3 Shoot.



Standard	Shots resemble toy camera images.
Warm	Images have a warmer tone than with [Standard].
Cool	Images have a cooler tone than with [Standard].



- Try taking some test shots first, to make sure you obtain the desired results.

## Shooting in Monochrome

Shoot images in black and white, sepia, or blue and white.

### 1 Choose [📷].

- Follow step 1 in “Specific Scenes” (📖51) and choose [📷].

### 2 Choose a color tone.

- Press the <▼> button, press the <◀><▶> buttons to choose a color tone, and then press the <FUNC SET> button.
- A preview is shown of how your shot will look with the effect applied.

### 3 Shoot.



B/W	Black and white shots.
Sepia	Sepia tone shots.
Blue	Blue and white shots.





## Shooting with Color Accent

Choose a single image color to keep and change other colors to black and white.

### 1 Choose [A].

- Follow step 1 in “Specific Scenes” (p.51) and choose [A].

### 2 Access the setting screen.

- Press the <▼> button.
- The original image and the Color Accent image are displayed one after another.
- By default, green is the color that will be kept.

### 3 Specify the color.

- Position the center frame over the color to keep, and then press the <◀> button.
- The specified color is recorded.

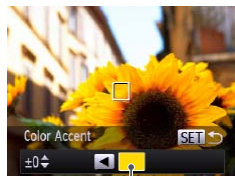

Recorded Color

### 4 Specify the range of colors to keep.

- Press the <▲><▼> buttons to adjust the range.
- To keep only your specified color, choose a large negative value. To keep colors similar to your specified color as well, choose a large positive value.
- Press the <◀<sup>FUNC</sup>SET> button to return to the shooting screen.

### 5 Shoot.

- ! Using the flash in this mode may cause unexpected results.
- ! In some shooting scenes, images may look grainy and colors may not look as expected.

Before Use

Basic Guide

Advanced Guide

Camera Basics

Using GPS  
Functions

Auto Mode

Other Shooting  
Modes

P Mode

Playback Mode

Setting Menu

Accessories

Appendix

Index



## Shooting with Color Swap

You can replace one image color with another before shooting. Note that only one color can be replaced.

### 1 Choose [1/s].

- Follow step 1 in “Specific Scenes” (p.51) and choose [1/s].

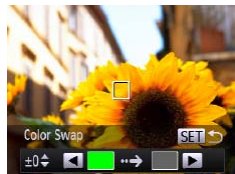

### 2 Access the setting screen.

- Press the <▼> button.
- The original image and the Color Swap image are displayed one after another.
- By default, green will be replaced with gray.



### 3 Specify the color to replace.

- Position the center frame over the color to replace, and then press the <◀> button.
- The specified color is recorded.

### 4 Specify the new color.

- Position the center frame over the new color, and then press the <▶> button.
- The specified color is recorded.



### 5 Specify the range of colors to replace.

- Press the <▲><▼> buttons to adjust the range.
- To replace only your specified color, choose a large negative value. To replace colors similar to your specified color as well, choose a large positive value.
- Press the <FUNC/SET> button to return to the shooting screen.

### 6 Shoot.



- Using the flash in this mode may cause unexpected results.
- In some shooting scenes, images may look grainy and colors may not look as expected.

Before Use

Basic Guide

Advanced Guide

Camera Basics

Using GPS  
Functions

Auto Mode

Other Shooting  
Modes

P Mode

Playback Mode

Setting Menu

Accessories

Appendix

Index



## Special Modes for Other Purposes

Still Images

Movies

### Auto Clip Recording (Movie Digest)

You can make a short movie of a day just by shooting still images. Before each shot, the camera will automatically record a movie clip of the scene. Each clip recorded that day is combined into a single file.



#### 1 Choose [M].

- Follow step 1 in “Specific Scenes” (p.51) and choose [M].

#### 2 Shoot.

- To shoot a still image, press the shutter button all the way down.
- Before shooting, the camera will automatically record a clip about 2 – 4 seconds long.



- Clips may not be recorded if you shoot a still image immediately after turning the camera on, choosing [M] mode, or operating the camera in other ways.
- Battery life is shorter in this mode than in [AUTO] mode, because clips are recorded for each shot.
- Any sounds from camera operations during movie recording will be included in the movie.



- [M] mode movie quality is [640] and cannot be changed.
- Clips are saved as separate movie files in the following cases even if they were recorded on the same day in [M] mode.
  - The movie file size reaches about 4 GB or the total recording time reaches approx. 1 hour.
  - The movie is protected (p.87).
  - Daylight saving time (p.16) or time zone (p.109) settings are changed.
  - A new folder is created (p.108).
- Sounds are not played when you press the shutter button halfway, use camera controls, or trigger the self-timer (p.104).
- Movies created in [M] mode can be viewed by date (p.85).

Before Use

Basic Guide

Advanced Guide

Camera Basics

Using GPS  
Functions

Auto Mode

Other Shooting  
Modes

P Mode

Playback Mode

Setting Menu

Accessories

Appendix

Index



## Auto Shooting after Face Detection (Smart Shutter)

### Auto Shooting after Smile Detection

The camera shoots automatically after detecting a smile, even without you pressing the shutter button.

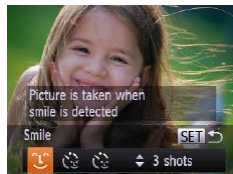

#### 1 Choose [☺].

- Follow step 1 in “Specific Scenes” (📖51) and choose [☺], and then press the <▼> button.
- Press the <◀><▶> buttons to choose [☺], and then press the <Ⓢ> button.
- The camera now enters shooting standby mode, and [Smile Detection on] is displayed.

#### 2 Aim the camera at a person.

- Each time the camera detects a smile, it will shoot after the lamp lights up.
- To pause smile detection, press the <◀> button. Press the <▶> button again to resume detection.



- Switch to another mode when you finish shooting, or the camera will continue shooting each time a smile is detected.



- You can also shoot as usual by pressing the shutter button.
- The camera can detect smiles more easily when subjects face the camera and open their mouth wide enough so that teeth are visible.
- To change the number of shots, press the <▲><▼> buttons after choosing [☺] in step 1. [Blink Detection] (👁47) is only available for the final shot.

Before Use

Basic Guide

Advanced Guide

Camera Basics

Using GPS  
Functions

Auto Mode

Other Shooting  
Modes

P Mode

Playback Mode

Setting Menu

Accessories

Appendix

Index



## Using the Wink Self-Timer

Aim the camera at a person and press the shutter button all the way down. The camera will shoot about two seconds after a wink is detected.

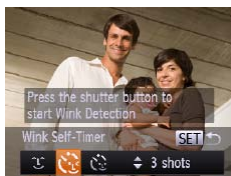

### 1 Choose [WINK].

- Follow step 1 in “Specific Scenes” (📖51) and choose [WINK], and then press the <▼> button.
- Press the <◀><▶> buttons to choose [WINK], and then press the <WINK SET> button.

### 2 Compose the shot and press the shutter button halfway.

- Make sure a green frame is displayed around the face of the person who will wink.

### 3 Press the shutter button all the way down.

- The camera now enters shooting standby mode, and [Wink to take picture] is displayed.
- The lamp blinks and the self-timer sound is played.

### 4 Face the camera and wink.

- The camera will shoot about two seconds after detecting a wink by the person whose face is inside the frame.
- To cancel shooting after you have triggered the self-timer, press the <MENU> button.



- If the wink is not detected, wink again slowly and deliberately.
- Winking may not be detected if eyes are obscured by hair, a hat, or glasses.
- Closing and opening both eyes at once will also be detected as a wink.
- If winking is not detected, the camera will shoot about 15 seconds later.
- To change the number of shots, press the <▲><▼> buttons after choosing [WINK] in step 1. [Blink Detection] (📖47) is only available for the final shot.
- If no one is in the shooting area when the shutter button is pressed all the way down, the camera will shoot after a person enters the shooting area and winks.

## Using the Face Self-Timer

The camera will shoot about two seconds after detecting that the face of another person (such as the photographer) has entered the shooting area (📖74). This is useful when including yourself in group photos or similar shots.



### 1 Choose [FACE].

- Follow step 1 in “Specific Scenes” (📖51) and choose [FACE], and then press the <▼> button.
- Press the <◀><▶> buttons to choose [FACE], and then press the <FACE SET> button.

### 2 Compose the shot and press the shutter button halfway.

- Make sure a green frame is displayed around the face you focus on and white frames around other faces.



### 3 Press the shutter button all the way down.

- The camera now enters shooting standby mode, and [Look straight at camera to start count down] is displayed.
- The lamp blinks and the self-timer sound is played.



### 4 Join the subjects in the shooting area and look at the camera.

- After the camera detects a new face, the lamp blinking and self-timer sound will speed up. (When the flash fires, the lamp will remain lit.) About two seconds later, the camera will shoot.
- To cancel shooting after you have triggered the self-timer, press the <MENU> button.



- Even if your face is not detected after you join the others in the shooting area, the camera will shoot about 15 seconds later.
- To change the number of shots, press the <▲><▼> buttons after choosing [ ] in step 1. [Blink Detection] ( ) is only available for the final shot.

## Shooting Long Exposures (Long Shutter)

Specify a shutter speed of 1 – 15 seconds to shoot long exposures. In this case, mount the camera on a tripod or take other measures to prevent camera shake.



### 1 Choose [ ].

- Follow step 1 in “Specific Scenes” ( ) and choose [ ].

### 2 Choose the shutter speed.

- Press the <FUNC/SET> button, choose [1"] in the menu, and choose the desired shutter speed ( ).

### 3 Check the exposure.

- Press the shutter button halfway to view the exposure for your selected shutter speed.

### 4 Shoot.



- On-screen image brightness in step 3, when you pressed the shutter button halfway, may not match the brightness of your shots.
- With shutter speeds of 1.3 seconds or slower, there will be a delay before you can shoot again, as the camera processes images to reduce noise.
- Set [IS Mode] to [Off] when using a tripod or other means to secure the camera (📖78).

- If the flash fires, your shot may be overexposed. In this case, set the flash to [🔚] and shoot again (📖77).

#### Still Images

## Shooting Stitch Assist Images

Shoot a large subject by taking multiple shots at various positions, and then use the software (📖119) to combine them into a panorama.

### 1 Choose [📷] or [📷].

- Follow step 1 in “Specific Scenes” (📖51) and choose [📷] or [📷].

### 2 Take the first shot.

- The first shot will determine the exposure and white balance.



### 3 Take additional shots.

- Compose the second shot so that it partially overlaps the image area of the first shot.
- Minor misalignment of overlapping portions will be corrected automatically when the images are combined.
- You can take up to 26 shots, the same way you took the second shot.

### 4 Finish shooting.

- Press the <[FUNC/SET]> button.

### 5 Use the software to combine the images.

- For instructions on merging images, refer to “Software Instruction Manual” (📖119).

Before Use

Basic Guide

Advanced Guide

Camera Basics

Using GPS  
Functions

Auto Mode

Other Shooting  
Modes

P Mode

Playback Mode

Setting Menu

Accessories

Appendix

Index



## Shooting Various Movies

### Shooting iFrame Movies

Shoot movies that can be edited with iFrame-compatible software or devices. You can quickly edit, save, and manage your iFrame movies using the software (📖119).

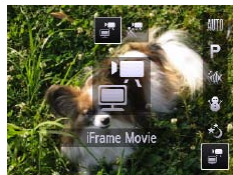

#### 1 Choose [📷].

- Follow step 1 in “Specific Scenes” (📖51) and choose [📷].
- Black bars displayed on the top and bottom edges of the screen indicate image areas not recorded.

#### 2 Shoot.

- Press the movie button.
- To stop movie recording, press the movie button again.



- The resolution is [1280] (📖45) and cannot be changed.
- iFrame is a video format developed by Apple Inc.

## Shooting Super Slow Motion Movies

You can shoot fast-moving subjects for playback later in slow motion. Note that sound is not recorded.

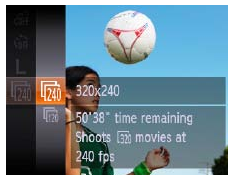

#### 1 Choose [📷].

- Follow step 1 in “Specific Scenes” (📖51) and choose [📷].

#### 2 Choose a frame rate.

- Press the <FUNC/SET> button, choose [📷] in the menu, and choose the desired frame rate (📖25).
- The option you configured is now displayed.

#### 3 Shoot.

- Press the movie button.
- A bar showing the elapsed time is displayed. Maximum clip length is approx. 30 sec.
- To stop movie recording, press the movie button again.

Frame Rate	Image Quality	Playback Time (For a 30-sec. Clip)
📷 240 fps	📷 (320 x 240)	Approx. 4 min.
📷 120 fps	📷 (640 x 480)	Approx. 2 min.









- Zooming is not available during recording, even if you press the zoom button.
- Focus, exposure, and color are determined when you press the movie button.



- When you play the movie (, 80), it will be played back in slow motion.
- You can change the playback speed of movies by using the software (, 119).

Before Use

Basic Guide

Advanced Guide

Camera Basics

Using GPS  
Functions

Auto Mode

Other Shooting  
Modes

P Mode

Playback Mode

Setting Menu

Accessories

Appendix

Index



# P Mode

More discerning shots, in your preferred shooting style

- Instructions in this chapter apply to the camera when set to **[P]** mode.
- **[P]**: Program AE; AE: Auto Exposure
- Before using a function introduced in this chapter in modes other than **[P]**, make sure the function is available in that mode (📖140 – 144).

<b>Shooting in Program AE ([P] Mode) .....</b>	<b>67</b>	<b>Color and Continuous Shooting.....</b>	<b>69</b>	<b>Flash.....</b>	<b>77</b>
<b>Image Brightness (Exposure) .....</b>	<b>67</b>	Adjusting White Balance .....	69	Changing the Flash Mode.....	77
Adjusting Image Brightness (Exposure Compensation) .....	67	Changing Image Color Tones (My Colors) .....	70	Shooting with the FE Lock .....	77
Locking Image Brightness / Exposure (AE Lock) .....	68	Continuous Shooting.....	71	Changing the IS Mode Settings .....	78
Changing the Metering Method.....	68	Shooting Close-Ups (Macro).....	72		
Changing the ISO Speed .....	69	Shooting in Manual Focus Mode.....	72		
Correcting Image Brightness (i-Contrast).....	69	Digital Tele-Converter.....	73		
		Changing the AF Frame Mode .....	74		
		Shooting with the AF Lock.....	76		

Before Use

Basic Guide

Advanced Guide

Camera Basics

Using GPS  
Functions

Auto Mode

Other Shooting  
Modes

P Mode

Playback Mode

Setting Menu

Accessories

Appendix

Index



## Shooting in Program AE ([P] Mode)

You can customize many function settings to suit your preferred shooting style.



### 1 Enter [P] mode.

- Follow step 1 in “Specific Scenes” (📖51) and choose [P].

### 2 Customize the settings as desired (📖67 – 78), and then shoot.



- If adequate exposure cannot be obtained when you press the shutter button halfway, shutter speeds and aperture values are displayed in orange. In this case, try adjusting the ISO speed (📖69) or activating the flash (if subjects are dark, 📖77), which may enable adequate exposure.
- Movies can be recorded in [P] mode as well, by pressing the movie button. However, some FUNC. (📖25) and MENU (📖26) settings may be automatically adjusted for movie recording.
- For details on the shooting range in [P] mode, see “Shooting Range” (📖148).

## Image Brightness (Exposure)

### Adjusting Image Brightness (Exposure Compensation)

The standard exposure set by the camera can be adjusted in 1/3-stop increments, in a range of -2 to +2.

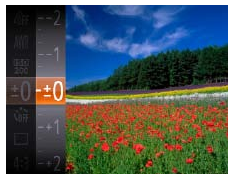

- Press the <FUNC SET> button and choose [ $\pm$ 0] in the menu. As you watch the screen, press the <▲><▼> buttons to adjust brightness (📖25).
- The correction level you specified is now displayed.

Before Use

Basic Guide

Advanced Guide

Camera Basics

Using GPS Functions

Auto Mode

Other Shooting Modes

P Mode

Playback Mode

Setting Menu

Accessories

Appendix

Index



## Locking Image Brightness / Exposure (AE Lock)

Before shooting, you can lock the exposure, or you can specify focus and exposure separately.

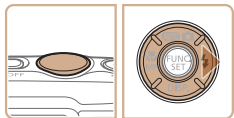

### 1 Deactivate the flash (📖 42).

### 2 Lock the exposure.

- Aim the camera at the subject to shoot with the exposure locked. With the shutter button pressed halfway, press the <▶> button.
- [AEL] is displayed, and the exposure is locked.
- To unlock AE, release the shutter button and press the <▶> button again. In this case, [AEL] is no longer displayed.

### 3 Compose the shot and shoot.



- AE: Auto Exposure

## Changing the Metering Method

Adjust the metering method (how brightness is measured) to suit shooting conditions as follows.



- Press the <Fn/SET> button, choose [☉] in the menu, and choose the desired option (📖 25).
- The option you configured is now displayed.

Evaluative	For typical shooting conditions, including backlit shots. Automatically adjusts exposure to match the shooting conditions.
Center Weighted Avg.	Determines the average brightness of light across the entire image area, calculated by treating brightness in the central area as more important.
Spot	Metering restricted to within the [ ] (Spot AE Point frame), displayed in the center of the screen.



## Changing the ISO Speed



- Press the **<FUNC/SET>** button, choose **[ISO]** in the menu, and choose the desired option (📖25).
- The option you configured is now displayed.

## Correcting Image Brightness (i-Contrast)

Before shooting, excessively bright or dark image areas (such as faces or backgrounds) can be detected and automatically adjusted to the optimal brightness. Insufficient overall image contrast can also be automatically corrected before shooting to make subjects stand out better.



- Press the **<MENU>** button, choose [i-Contrast] on the **[CAMERA]** tab, and then choose [Auto] (📖26).
- Once the setting is complete, **[Ci]** is displayed.

- ⚠ Under some shooting conditions, correction may be inaccurate or may cause images to appear grainy.

- ✎ You can also correct existing images (📖100).

## Color and Continuous Shooting

### Adjusting White Balance

By adjusting white balance (WB), you can make image colors look more natural for the scene you are shooting.



- Press the **<FUNC/SET>** button, choose **[WB]** in the menu, and choose the desired option (📖25).
- The option you configured is now displayed.

<b>AWB</b> Auto	Automatically sets the optimal white balance for the shooting conditions.
Day Light	For shooting outdoors in fair weather.
Cloudy	For shooting in cloudy conditions, in the shade, or at twilight.
Tungsten	For shooting under ordinary incandescent (tungsten) lighting and similarly colored fluorescent lighting.
Fluorescent	For shooting under warm-white (or similarly colored) or cool-white fluorescent lighting.
Fluorescent H	For shooting under daylight fluorescent and similarly colored fluorescent lighting.
Underwater	For shooting underwater (📖53).
Custom	For manually setting a custom white balance.



## Custom White Balance

For image colors that look natural under the light in your shot, adjust white balance to suit the light source where you are shooting. Set the white balance under the same light source that will illuminate your shot.

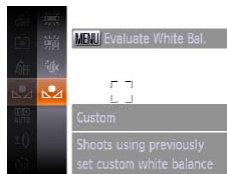

- Follow the steps in “Adjusting White Balance” (69) to choose [Custom].
- Aim the camera at a plain white subject, so that the entire screen is white. Press the <MENU> button.
- The tint of the screen changes once the white balance data has been recorded.



- Colors may look unnatural if you change camera settings after recording white balance data.

## Changing Image Color Tones (My Colors)

Change image color tones as desired, such as converting images to sepia or black and white.

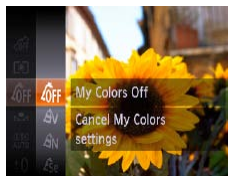

- Press the <FUNC/SET> button, choose [OFF] in the menu, and choose the desired option (25).
- The option you configured is now displayed.

My Colors Off	—
Vivid	Emphasizes contrast and color saturation, making images sharper.
Neutral	Tones down contrast and color saturation for subdued images.
Sepia	Creates sepia tone images.
B/W	Creates black and white images.
Positive Film	Combines the effects of Vivid Blue, Vivid Green, and Vivid Red to produce intense yet natural-looking colors resembling images on positive film.
Lighter Skin Tone	Lightens skin tones.
Darker Skin Tone	Darkens skin tones.
Vivid Blue	Emphasizes blues in images. Makes the sky, ocean, and other blue subjects more vivid.
Vivid Green	Emphasizes greens in images. Makes mountains, foliage, and other green subjects more vivid.
Vivid Red	Emphasizes reds in images. Makes red subjects more vivid.
Custom Color	Adjust contrast, sharpness, color saturation, and other qualities as desired.





- White balance (📖69) cannot be set in [A<sub>S</sub>] or [A<sub>SW</sub>] modes.
- With [A<sub>L</sub>] and [A<sub>D</sub>] modes, colors other than people's skin tone may change. These settings may not produce the expected results with some skin tones.

Still Images

Movies

## Custom Color

Choose the desired level of image contrast, sharpness, color saturation, red, green, blue, and skin tones in a range of 1 – 5.

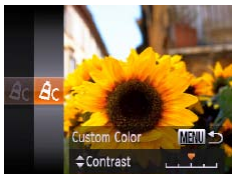

### 1 Access the setting screen.

- Follow the steps in “Changing Image Color Tones (My Colors)” (📖70) to choose [A<sub>C</sub>], and then press the <MENU> button.

### 2 Configure the setting.

- Press the <▲><▼> buttons to choose an option, and then specify the value by pressing the <◀><▶> buttons.
- For stronger/more intense effects (or darker skin tones), adjust the value to the right, and for weaker/lighter effects (or lighter skin tones), adjust the value to the left.
- Press the <MENU> button to complete the setting.

Still Images

## Continuous Shooting

Hold the shutter button all the way down to shoot continuously. For details on the continuous shooting speed, see “Continuous Shooting Speed” (📖149).



### 1 Configure the setting.

- Press the <FRM SET> button, choose [ ] in the menu, and then choose [ ] (📖25).
- Once the setting is complete, [ ] is displayed.

### 2 Shoot.

- Hold the shutter button all the way down to shoot continuously.



- Cannot be used with the self-timer (📖40) or [Blink Detection] (📖47).
- During continuous shooting, focus and exposure are locked at the position/level determined when you pressed the shutter button halfway.
- Shooting may stop momentarily or continuous shooting may slow down depending on shooting conditions, camera settings, and the zoom position.
- As more shots are taken, shooting may slow down.
- Shooting may slow down if the flash fires.

Before Use

Basic Guide

Advanced Guide

Camera Basics

Using GPS Functions

Auto Mode

Other Shooting Modes

P Mode

Playback Mode

Setting Menu

Accessories

Appendix

Index



## Shooting Close-Ups (Macro)

To restrict the focus to subjects at close range, set the camera to [M]. For details on the focusing range, see “Shooting Range” (148).

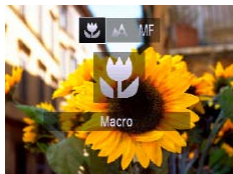

- Press the <<> button, press the <<><>> buttons to choose [M], and then press the <FUNC/SET> button.
- Once the setting is complete, [M] is displayed.



- In the yellow bar display area below the zoom bar, [M] will turn gray and the camera will not focus.



- To prevent camera shake, try mounting the camera on a tripod and shooting with the camera set to [M] (41).

## Shooting in Manual Focus Mode

When focusing is not possible in AF mode, use manual focus. You can specify the general focal position and then press the shutter button halfway to have the camera determine the optimal focal position near the position you specified. For details on the focusing range, see “Shooting Range” (148).



MF Indicator

### 1 Choose [MF].

- Press the <<> button, press the <<><>> buttons to choose [MF], and then immediately press the <>><> buttons.

### 2 Specify the general focal position.

- Referring to the on-screen MF indicator bar (which shows the distance and focal position) and the magnified display area, press the <>><> buttons to specify the general focal position, and then press the <FUNC/SET> button.

### 3 Fine-tune the focus.

- Press the shutter button halfway to have the camera fine-tune the focal position (Safety MF).







- When you focus manually, the AF frame mode (📖74) is [Center] and AF frame size (📖74) is [Normal], and these settings cannot be changed.
- Focusing is possible when using the digital zoom (📖40) or digital tele-converter (📖73), or when using a TV as a display (📖118), but the magnified display will not appear.



- To focus more accurately, try attaching the camera to a tripod to stabilize it.
- To hide the magnified display area, choose MENU (📖26) > [📷] tab > [MF-Point Zoom] > [Off].
- To deactivate automatic focus fine-tuning when the shutter button is pressed halfway, choose MENU (📖26) > [📷] tab > [Safety MF] > [Off].



## Digital Tele-Converter

The focal length of the lens can be increased by approximately 1.5x or 2.0x. This can reduce camera shake because the shutter speed is faster than it would be if you zoomed (including using digital zoom) in to the same zoom factor.



- Press the <MENU> button, choose [Digital Zoom] on the [📷] tab, and then choose the desired option (📖26).
- The view is enlarged and the zoom factor is displayed on the screen.



- Images will look grainy at a resolution (📖44) of [L] or [M1]. In this case, the zoom factor is shown in blue.
- The digital tele-converter cannot be used with digital zoom (📖40) or AF-point zoom (📖46).
- The digital tele-converter is only available when the aspect ratio is [4:3].



- The shutter speed may be equivalent whether you press the <[📷]> zoom button for maximum telephoto or you zoom in to enlarge the subject to the same size following step 2 in "Zooming In Closer on Subjects (Digital Zoom)" (📖40).



## Changing the AF Frame Mode

Change the AF (auto focus) frame mode to suit the shooting conditions as follows.



- Press the <MENU> button, choose [AF Frame] on the [CAMERA] tab, and then choose the desired option (📖26).

## Face AiAF

- Detects people's faces, and then sets the focus, exposure (evaluative metering only), and white balance ([AWB] only).
- After you aim the camera at the subject, a white frame is displayed around the person's face determined by the camera to be the main subject, and up to two gray frames are displayed around other detected faces.
- When the camera detects movement, frames will follow moving subjects, within a certain range.
- After you press the shutter button halfway, up to nine green frames are displayed around faces in focus.



- If faces are not detected, or when only gray frames are displayed (without a white frame), up to nine green frames are displayed in the areas in focus when you press the shutter button halfway.
- If faces are not detected when Servo AF (📖76) is set to [On], the AF frame is displayed in the center of the screen when you press the shutter button halfway.
- Examples of faces that cannot be detected:
  - Subjects that are distant or extremely close
  - Subjects that are dark or light
  - Faces in profile, at an angle, or partly hidden
- The camera may misinterpret non-human subjects as faces.
- No AF frames are displayed if the camera cannot focus when you press the shutter button halfway.

## Center

One AF frame is displayed in the center. Effective for reliable focusing.



- A yellow AF frame is displayed with [❗] if the camera cannot focus when you press the shutter button halfway.



- To reduce the AF frame size, press the <MENU> button and set [AF Frame Size] on the [CAMERA] tab to [Small] (📖26).
- The AF frame size is set to [Normal] when you use the digital zoom (📖40) or digital tele-converter (📖73), and in manual focus mode (📖72).
- To compose shots so that subjects are positioned at the edge or in a corner, first aim the camera to capture the subject in an AF frame, and then hold the shutter button halfway down. As you continue to hold the shutter button halfway, recompose the shot as desired, and then press the shutter button all the way down (Focus Lock).
- The AF frame position is enlarged when you press the shutter button halfway and [AF-Point Zoom] (📖46) is set to [On].



## Choosing Subjects to Focus On (Tracking AF)

Shoot after choosing a subject to focus on as follows.

### 1 Choose [Tracking AF].

- Follow the steps in “Changing the AF Frame Mode” (74) to choose [Tracking AF].
- [ ] is displayed in the center of the screen.



### 2 Choose a subject to focus on.

- Aim the camera so that [ ] is on the desired subject, and then press the <<> button.
- When the subject is detected, the camera beeps and [ ] is displayed. Even if the subject moves, the camera will continue to track the subject within a certain range.
- If no subject is detected, [ ] is displayed.
- To cancel tracking, press the <<> button again.



### 3 Shoot.

- Press the shutter button halfway. [ ] changes to a blue [ ], which follows the subject as the camera continues to adjust the focus and exposure (Servo AF) (76).
- Press the shutter button all the way down to shoot.
- Even after your shot, [ ] is still displayed and the camera continues to track the subject.



- [Servo AF] (76) is set to [On] and cannot be changed.
- Tracking may not be possible when subjects are too small or move too rapidly, or when subject color or brightness matches that of the background too closely.
- [AF-Point Zoom] on the [ ] tab is not available.
- [ ] is not available.



- The camera can detect subjects even if you press the shutter button halfway without pressing the <<> button. After your shot, [ ] is displayed in the center of the screen.
- When shooting in [MF] mode (72), press and hold the <<> button for at least one second.

Before Use

Basic Guide

Advanced Guide

Camera Basics

Using GPS  
Functions

Auto Mode

Other Shooting  
Modes

P Mode

Playback Mode

Setting Menu

Accessories

Appendix

Index



## Shooting with Servo AF

This mode helps avoid missing shots of subjects in motion, because the camera continues to focus on the subject and adjust the exposure as long as you press the shutter button halfway.

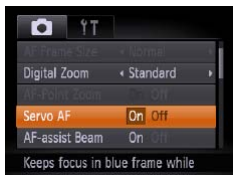

### 1 Configure the setting.

- Press the <MENU> button, choose [Servo AF] on the [CAMERA] tab, and then choose [On] (📖26).

### 2 Focus.

- The focus and exposure are maintained where the blue AF frame is displayed while you are pressing the shutter button halfway.



- Focusing may not be possible in some shooting conditions.
- In low-light conditions, Servo AF may not be activated (AF frames may not turn blue) when you press the shutter button halfway. In this case, the focus and exposure are set according to the specified AF frame mode.
- If adequate exposure cannot be obtained, shutter speeds and aperture values are displayed in orange. Release the shutter button, and then press it halfway again.
- AF lock shooting is not available.
- [AF-Point Zoom] on the [CAMERA] tab is not available.
- Not available when using the self-timer (📖40).

## Shooting with the AF Lock

The focus can be locked. After you lock the focus, the focal position will not change even when you release your finger from the shutter button.

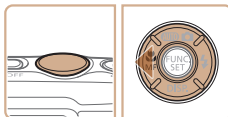

### 1 Lock the focus.

- With the shutter button pressed halfway, press the <L/AF-ON> button.
- The focus is now locked, and [AFL] is displayed.
- To unlock the focus, release the shutter button and press the <L/AF-ON> button again. In this case, [AFL] is no longer displayed.

### 2 Compose the shot and shoot.



## Changing the Flash Mode

You can change the flash mode to match the shooting scene. For details on the flash range, see “Flash Range” (📖148).



### 1 Configure the setting.

- Press the <▶> button, press the <<▶><<▶> buttons to choose a flash mode, and then press the <FUNC SET> button.
- The option you configured is now displayed.

### [4A] Auto

Fires automatically in low-light conditions.

### [On] On

Fires for each shot.

### [Slow Synchro] Slow Synchro

Fires to illuminate the main subject (such as people) while shooting at a slower shutter speed to illuminate backgrounds out of flash range.



- In [4A] mode, mount the camera on a tripod or take other measures to keep it still and prevent camera shake. Additionally, you should set [IS Mode] to [Off] when using a tripod or other means to secure the camera (📖78).
- In [Slow Synchro] mode, even after the flash fires, ensure that the main subject does not move until the shutter sound is finished playing.

### [Off] Off

For shooting without the flash.



- If a blinking [On] icon is displayed when you press the shutter button halfway in camera-shake inducing, low-light conditions, mount the camera on a tripod or take other measures to keep it still.

## Shooting with the FE Lock

Just as with the AE lock (📖68), you can lock the exposure for the flash shots.

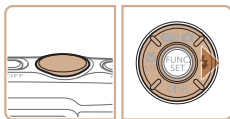

### 1 Set the flash to [4A] (📖77).

### 2 Lock the flash exposure.

- Aim the camera at the subject to shoot with the exposure locked. With the shutter button pressed halfway, press the <▶> button.
- The flash fires, and when [FEL] is displayed, the flash output level is retained.
- To unlock FE, release the shutter button and press the <▶> button again. In this case, [FEL] is no longer displayed.

### 3 Compose the shot and shoot.





• FE: Flash Exposure

Still Images

Movies

## Changing the IS Mode Settings



### 1 Access the setting screen.

- Press the <MENU> button, choose [IS Settings] on the [CAMERA] tab, and then press the <FUNC SET> button (📖26).

### 2 Configure the setting.

- Choose [IS Mode], and then choose the desired option (📖26).

Continuous	Optimal image stabilization for the shooting conditions is automatically applied (Intelligent IS) (📖39).
Shoot Only*	Image stabilization is active only at the moment of shooting.
Off	Deactivates image stabilization.

\* The setting is changed to [Continuous] for movie recording.



- If image stabilization cannot prevent camera shake, mount the camera on a tripod or take other measures to hold it still. In this case, set [IS Mode] to [Off].

Movies

## Deactivating Powered IS

Powered IS reduces slow camera shake that may occur when recording telephoto movies. However, this option may not produce the expected results when used for the stronger camera shake that may occur when shooting while walking or when moving the camera to match subject movement. In this case, set Powered IS to [Off].



- Follow the steps in “Changing the IS Mode Settings” (📖78) to access the [IS Settings] screen.
- Choose [Powered IS], and then choose [Off] (📖39).



- [Powered IS] settings are not applied when [IS Mode] is set to [Off].

Before Use

Basic Guide

Advanced Guide

Camera Basics

Using GPS  
Functions

Auto Mode

Other Shooting  
Modes

P Mode

Playback Mode

Setting Menu

Accessories

Appendix

Index



# Playback Mode

Have fun reviewing your shots, and browse or edit them in many ways

- To prepare the camera for these operations, press the <▶> button to enter Playback mode.



- It may not be possible to play back or edit images that were renamed or already edited on a computer, or images from other cameras.

<b>Viewing</b> .....	<b>80</b>	<b>Protecting Images</b> .....	<b>87</b>	<b>Editing Still Images</b> .....	<b>97</b>
Active Display.....	81	Using the Menu.....	88	Resizing Images.....	97
Switching Display Modes.....	82	Choosing Images Individually.....	88	Cropping.....	98
Checking the Focus.....	83	Selecting a Range.....	89	Changing Image Color Tones (My Colors).....	99
<b>Browsing and Filtering Images</b> .....	<b>83</b>	Specifying All Images at Once.....	90	Correcting Image Brightness (i-Contrast).....	100
Navigating through Images in an Index.....	83	<b>Erasing Images</b> .....	<b>90</b>	Correcting Red-Eye.....	100
Finding Images Matching Specified Conditions.....	84	Erasing Multiple Images at Once.....	91	<b>Editing Movies</b> .....	<b>101</b>
Viewing Movie Digest Short Movies.....	85	<b>Rotating Images</b> .....	<b>93</b>		
<b>Image Viewing Options</b> .....	<b>85</b>	Using the Menu.....	93		
Magnifying Images.....	85	Deactivating Auto Rotation.....	94		
Viewing Slideshows.....	86	<b>Image Categories</b> .....	<b>94</b>		
Auto Playback of Related Images		Tagging Images as Favorites.....	94		
(Smart Shuffle).....	87	Organizing Images by Category (My Category)....	95		

Before Use

Basic Guide

Advanced Guide

Camera Basics

Using GPS  
Functions

Auto Mode

Other Shooting  
Modes

P Mode

Playback Mode

Setting Menu

Accessories

Appendix

Index



# Viewing

After shooting images or movies, you can view them on the screen as follows.

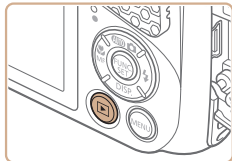

## 1 Enter Playback mode.

- Press the button.
- Your last shot is displayed.



## 2 Browse through your images.

- To view the previous image, press the button. To view the next image, press the button.

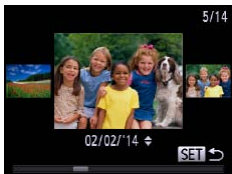

- To access Scroll Display mode, press and hold the buttons for at least one second. In this mode, press the buttons to browse through images.
- To return to single-image display, press the button.
- To browse images grouped by shooting date, press the buttons in Scroll Display mode.

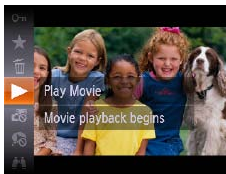

- Movies are identified by a icon. To play movies, go to step 3.

## 3 Play movies.

- To start playback, press the button, press the buttons to choose , and then press the button again.

## 4 Adjust the volume.

- Press the buttons to adjust the volume.

## 5 Pause playback.

- To pause or resume playback, press the button.
- After the movie is finished, is displayed.

Before Use

Basic Guide

Advanced Guide

Camera Basics

Using GPS  
Functions

Auto Mode

Other Shooting  
Modes

P Mode

Playback Mode

Setting Menu

Accessories

Appendix

Index







- To switch to Shooting mode from Playback mode, press the shutter button halfway.
- To deactivate Scroll Display, choose MENU (📖26) > [▶] tab > [Scroll Display] > [Off].
- To have the most recent shot displayed when you enter Playback mode, choose MENU (📖26) > [▶] tab > [Resume] > [Last shot].
- To change the transition shown between images, access MENU (📖26) and choose your desired effect in [▶] tab > [Transition].

## Active Display

To switch images during image display, you can tap the camera gently on the side, as shown below.

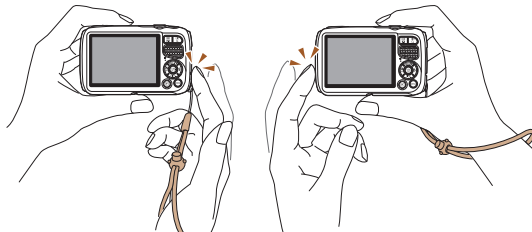

Switch to next image

Switch to previous image



- Always keep the strap around your wrist and hold the camera securely to avoid dropping it.
- Images may not be switched in some cases, depending on how the camera is tapped.



- To switch images quickly while images are selected as described in step 2 of “Viewing” (📖80) (after you press the <MENU> button and deactivate [Scroll Display] on the [▶] tab), hold down the <◀> button and tilt the camera. Note that images appear grainy at this time.
- To deactivate Active Display, press the <MENU> button, choose [Active Display] on the [▶] tab, and then choose [Off] (📖26).



## Switching Display Modes

Press the <▼> button to view other information on the screen, or to hide the information. For details on the information displayed, see “Playback (Detailed Information Display)” (📖138).

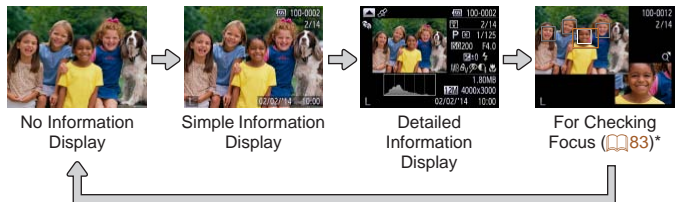

\* Not shown for movies.



- Switching display modes by pressing the <▼> button is also possible immediately after you shoot, while your shot is displayed. However, simple information display is not available. To change the initial display mode, press the <MENU> button and choose [Review Info] on the [📷] tab (📖49).

## Overexposure Warning (for Image Highlights)

Washed-out highlights in the image flash on the screen in detailed information display (📖82).

## Histogram

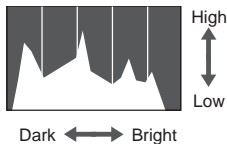

- The graph in detailed information display (📖82) is a histogram showing the distribution of brightness in the image. The horizontal axis represents the degree of brightness, and the vertical axis, how much of the image is at each level of brightness. Viewing the histogram is a way to check exposure.

## GPS Information Display

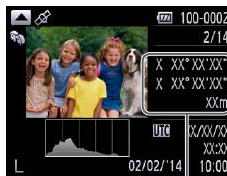

GPS Information

- To view still image and movie location information (latitude, longitude, and elevation recorded when [GPS] was set to [On] (📖30)) and the shooting date and time, press the <▲> button in detailed information display.
- Latitude, longitude, elevation, and UTC (shooting date and time) are listed from top to bottom.
- Press the <▲> button again to return to detailed information display.



- [--] shown instead of numerical values indicates that the information was not received from GPS satellites, or that accurate positioning was not possible.



- UTC: Coordinated Universal Time, essentially the same as Greenwich Mean Time



## Checking the Focus

To check the focus of your shots, you can magnify the area of the image that was in the AF frame at the time of shooting.

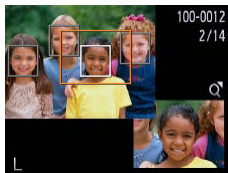

### 1 Access Focus Check.

- Press the <▼> button (82).
- A white frame is displayed where the AF frame was when the focus was set.
- Gray frames are displayed over faces detected later, in Playback mode.
- The portion of the image in the orange frame is magnified.

### 2 Switch frames.

- Press the <Q> zoom button once.
- The screen at left is displayed.
- To switch to a different frame when there are multiple frames, press the <FUNC SET> button.



### 3 Zoom in or out, or view other image areas.

- As you examine the focus, press the zoom buttons to zoom in or out. Press the <▲><▼><◀><▶> buttons to adjust the display position.
- Press the <MENU> button to restore the original display in step 1.

## Browsing and Filtering Images

### Navigating through Images in an Index

By displaying multiple images in an index, you can quickly find the images you are looking for.

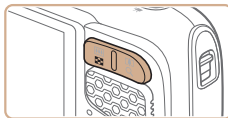

### 1 Display images in an index.

- Press the <☒> zoom button to display images in an index. Pressing the button again will increase the number of images shown.
- To display fewer images, press the <Q> zoom button. Fewer images are shown each time you press the button.

### 2 Choose an image.

- Press the <▲><▼><◀><▶> buttons to choose an image.
- An orange frame is displayed around the selected image.
- Press the <FUNC SET> button to view the selected image in single-image display.



## Finding Images Matching Specified Conditions

Find desired images quickly on a memory card full of images by filtering image display according to your specified conditions. You can also protect (📖87) or delete (📖90) these images all at once.

★ Favorites	Displays images tagged as favorites (📖94).
🕒 Shot Date	Displays the images shot on a specific date.
📁 My Category	Displays the images of a specific category (📖95).
📷 Still image/Movie	Displays still images, movies, or movies shot in [📷] mode (📖59).



### 1 Choose a search condition.

- Press the <FUNC/SET> button, choose [📷] in the menu, and choose a condition (📖25).
- When you have selected [🕒], [📁], or [📷], choose the condition by pressing the <▲><▼><◀><▶> buttons on the screen displayed, and then press the <FUNC/SET> button.



### 2 View the filtered images.

- Images matching your conditions are displayed in yellow frames. To view only these images, press the <◀><▶> buttons.
- To cancel filtered display, choose [📷] in step 1.



- To show or hide information, press the <▼> button in step 2.
- Options for viewing the images found (in step 2) include “Navigating through Images in an Index” (📖83), “Magnifying Images” (📖85), and “Viewing Slideshows” (📖86). You can protect, erase, or print all images found or add them to a photobook by choosing [Select All Images in Search] in “Protecting Images” (📖87), “Erasing Multiple Images at Once” (📖91), “Adding Images to the Print List (DPOF)” (📖126), or “Adding Images to a Photobook” (📖128).
- If you recategorize images (📖95) or edit them and save them as new images (📖98 – 101), a message is displayed, and the images that were found are no longer shown.



- When the camera has found no corresponding images for some conditions, those conditions will not be available.

Before Use

Basic Guide

Advanced Guide

Camera Basics

Using GPS Functions

Auto Mode

Other Shooting Modes

P Mode

Playback Mode

Setting Menu

Accessories

Appendix

Index



## Viewing Movie Digest Short Movies

Short movies created in [M] mode (859) can be viewed by date.

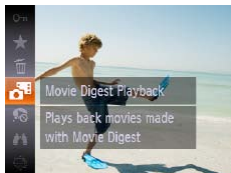

### 1 Choose a movie.

- Press the <FUNC/SET> button, choose [M] in the menu, and choose the date (825).

### 2 Play the movie.

- Press the <FUNC/SET> button to start playback.

## Image Viewing Options

### Magnifying Images

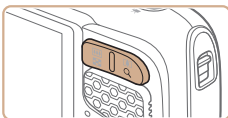

Approximate Position of Displayed Area

### 1 Magnify an image.

- Pressing the <Q> zoom button will zoom in and magnify the image. You can magnify images up to about 10x by continuing to hold the button down.
- To zoom out, press the <Q> zoom button. You can return to single-image display by continuing to hold it.

### 2 Move the display position and switch images as needed.

- To move the display position, press the <▲><▼><◀><▶> buttons.
- While [SET] is displayed, you can switch to [SET] by pressing the <FUNC/SET> button. To switch to other images while zoomed, press the <◀><▶> buttons. Press the <FUNC/SET> button again to restore the original setting.
- You can also switch images while zoomed by tapping the side of the camera gently (881, Active Display).



- You can return to single-image display from magnified display by pressing the <MENU> button.



## Viewing Slideshows

Automatically play back images from a memory card as follows. Each image is displayed for about three seconds.



- Press the button, choose in the menu, and choose the desired option ([25](#)).
- The slideshow will start after [Loading image] is displayed for a few seconds.
- Press the button to stop the slideshow.



- The camera's power-saving functions ([23](#)) are deactivated during slideshows.



- To pause or resume slideshows, press the button.
- You can switch to other images during playback by pressing the buttons. For fast-forward or fast-rewind, hold the buttons down.
- In image search mode ([84](#)), only images matching search conditions are played.
- You can switch images during slideshows by tapping the side of the camera gently ([81](#), Active Display).

## Changing Slideshow Settings

You can set up slideshows to repeat, and you can change the transitions between images and the display duration of each image.



### 1 Access the setting screen.

- Press the button, and then choose [Slideshow] on the tab ([26](#)).

### 2 Configure the settings.

- Choose a menu item to configure, and then choose the desired option ([26](#)).
- To start the slideshow with your settings, choose [Start] and press the .
- To return to the menu screen, press the .



- [Play Time] cannot be modified when [Bubble] is chosen in [Effect].

Before Use

Basic Guide

Advanced Guide

Camera Basics

Using GPS  
Functions

Auto Mode

Other Shooting  
Modes

P Mode

Playback Mode

Setting Menu

Accessories

Appendix

Index



## Auto Playback of Related Images (Smart Shuffle)

Based on the current image, the camera offers four images that you may wish to view. After you choose to view one of those images, the camera offers four more images. This is an enjoyable way to play back images in an unexpected order. Try this feature after you have taken many shots, in many kinds of scenes.

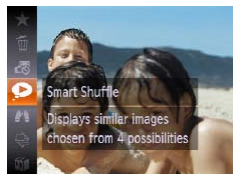

### 1 Choose Smart Shuffle.

- Press the button, and then choose in the menu (📖25).
- Four candidate images are displayed.

### 2 Choose an image.

- Press the buttons to choose the image you want to view next.
- Your chosen image is displayed in the center, surrounded by the next four candidate images.
- For full-screen display of the center image, press the button. To restore the original display, press the button again.
- Press the button to restore single-image display.

- Only still images shot with this camera are played back using Smart Shuffle.
- Smart Shuffle is not available in the following cases:
    - There are less than 50 shots taken with this camera
    - An unsupported image is currently displayed
    - Images are shown in filtered display (📖84)

## Protecting Images

Protect important images to prevent accidental erasure by the camera (📖90).



- Press the button, and then choose in the menu (📖25). [Protected] is displayed.
- To cancel protection, repeat this process and choose again, and then press the button.

- Protected images on a memory card will be erased if you format the card (📖106, 107).
- Protected images cannot be erased using the camera's erasure function. To erase them this way, first cancel protection.



## Using the Menu

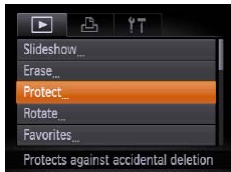

### 1 Access the setting screen.

- Press the <MENU> button and choose [Protect] on the [MENU] tab (📖26).



### 2 Choose a selection method.

- Choose a menu item and an option as desired (📖26).
- To return to the menu screen, press the <MENU> button.

## Choosing Images Individually



### 1 Choose [Select].

- Following step 2 in “Using the Menu” (📖88), choose [Select] and press the <FUNC/SET> button.

### 2 Choose an image.

- Press the <◀><▶> buttons to choose an image, and then press the <FUNC/SET> button. [OK] is displayed.
- To cancel selection, press the <FUNC/SET> button again. [OK] is no longer displayed.
- Repeat this process to specify other images.

### 3 Protect the image.

- Press the <MENU> button. A confirmation message is displayed.
- Press the <◀><▶> buttons to choose [OK], and then press the <FUNC/SET> button.



- Images will not be protected if you switch to Shooting mode or turn the camera off before finishing the setup process in step 3.

Before Use

Basic Guide

Advanced Guide

Camera Basics

Using GPS  
Functions

Auto Mode

Other Shooting  
Modes

P Mode

Playback Mode

Setting Menu

Accessories

Appendix

Index









## Selecting a Range

### 1 Choose [Select Range].





- Following step 2 in “Using the Menu” (p. 88), choose [Select Range] and press the  button.

### 2 Choose a starting image.



- Press the  button.
  
- Press the   buttons to choose an image, and then press the  button.



### 3 Choose an ending image.

- Press the  button to choose [Last image], and then press the  button.
  
- Press the   buttons to choose an image, and then press the  button.
- Images before the first image cannot be selected as the last image.

### 4 Protect the images.

- Press the  button to choose [Protect], and then press the  button.

Before Use

Basic Guide

Advanced Guide

Camera Basics

Using GPS  
Functions

Auto Mode

Other Shooting  
Modes

P Mode

Playback Mode

Setting Menu

Accessories

Appendix

Index





## Specifying All Images at Once

### 1 Choose [Select All Images].

- Following step 2 in “Using the Menu” (📖88), choose [Select All Images] and press the  button.

### 2 Protect the images.

- Press the  buttons to choose [Protect], and then press the  button.



- To cancel protection for groups of images, choose [Unlock] in step 4 of “Selecting a Range” or in step 2 of “Specifying All Images at Once”.



## Erasing Images

Still Images







Movies

You can choose and erase unneeded images one by one. Be careful when erasing images, because they cannot be recovered. However, protected images (📖87) cannot be erased.

### 1 Choose an image to erase.

- Press the  buttons to choose an image.

### 2 Erase the image.

- Press the  button, and then choose [Erase] in the menu (📖25).
- After [Erase?] is displayed, press the  buttons to choose [Erase], and then press the  button.
- The current image is now erased.
- To cancel erasure, press the  buttons to choose [Cancel], and then press the  button.



Before Use

Basic Guide

Advanced Guide

Camera Basics

Using GPS Functions

Auto Mode

Other Shooting Modes

P Mode

Playback Mode

Setting Menu

Accessories

Appendix

Index



## Erasing Multiple Images at Once

You can choose multiple images to erase at once. Be careful when erasing images, because they cannot be recovered. However, protected images (📖87) cannot be erased.

### Choosing a Selection Method

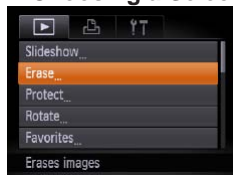

#### 1 Access the setting screen.

- Press the <MENU> button, and then choose [Erase] on the [📺] tab (📖26).

#### 2 Choose a selection method.

- Choose a menu item and an option as desired (📖26).
- Press the <▲><▼> buttons to choose a selection method, and then press the <FUNC SET> button.
- To return to the menu screen, press the <MENU> button.

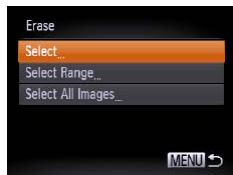

### Choosing Images Individually

#### 1 Choose [Select].

- Following step 2 in “Choosing a Selection Method” (📖91), choose [Select] and press the <FUNC SET> button.



#### 2 Choose an image.

- Once you choose an image following step 2 in “Choosing Images Individually” (📖88), [✓] is displayed.
- To cancel selection, press the <FUNC SET> button again. [✓] is no longer displayed.
- Repeat this process to specify other images.

#### 3 Erase the image.

- Press the <MENU> button. A confirmation message is displayed.
- Press the <◀><▶> buttons to choose [OK], and then press the <FUNC SET> button.



Before Use

Basic Guide

Advanced Guide

Camera Basics

Using GPS Functions

Auto Mode

Other Shooting Modes

P Mode

Playback Mode

Setting Menu

Accessories

Appendix

Index



## ■ Selecting a Range



### 1 Choose [Select Range].

- Following step 2 in “Choosing a Selection Method” (📖91), choose [Select Range] and press the  button.

### 2 Choose images.

- Follow steps 2 – 3 in “Selecting a Range” (📖89) to specify images.

### 3 Erase the images.

- Press the  button to choose [Erase], and then press the  button.



## ■ Specifying All Images at Once

### 1 Choose [Select All Images].

- Following step 2 in “Choosing a Selection Method” (📖91), choose [Select All Images] and press the  button.

### 2 Erase the images.

- Press the  < >  buttons to choose [OK], and then press the  button.



Before Use

Basic Guide

Advanced Guide

Camera Basics

Using GPS  
Functions

Auto Mode

Other Shooting  
Modes

P Mode

Playback Mode

Setting Menu

Accessories

Appendix

Index



## Rotating Images

Change the orientation of images and save them as follows.

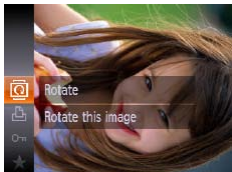

### 1 Choose [Q].

- Press the <FUNC SET> button, and then choose [Q] in the menu (📖25).

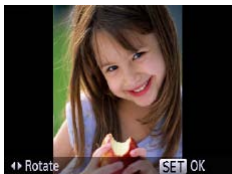

### 2 Rotate the image.

- Press the <◀> or <▶> button, depending on the desired direction. Each time you press the button, the image is rotated 90°. Press the <FUNC SET> button to complete the setting.

## Using the Menu



### 1 Choose [Rotate].

- Press the <MENU> button and choose [Rotate] on the [▶] tab (📖26).



### 2 Rotate the image.

- Press the <◀> buttons to choose an image.
- The image is rotated 90° each time you press the <FUNC SET> button.
- To return to the menu screen, press the <MENU> button.

- ⚠ Movies with an image quality of [F1920] or [F1280] cannot be rotated.
- Rotation is not possible when [Auto Rotate] is set to [Off] (📖94).

Before Use

Basic Guide

Advanced Guide

Camera Basics

Using GPS  
Functions

Auto Mode

Other Shooting  
Modes

P Mode

Playback Mode

Setting Menu

Accessories

Appendix

Index



## Deactivating Auto Rotation

Follow these steps to deactivate automatic image rotation, which rotates images based on the current camera orientation.

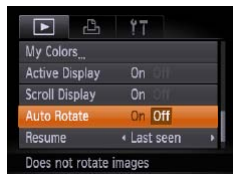

- Press the <MENU> button, choose [Auto Rotate] on the [▶] tab, and then choose [Off] (📖26).



- Images cannot be rotated (📖93) when you set [Auto Rotate] to [Off]. Additionally, images already rotated will be displayed in the original orientation.
- In Smart Shuffle (📖87) mode, even if [Auto Rotate] is set to [Off], images shot vertically will be displayed vertically, and rotated images will be displayed in the rotated orientation.

## Image Categories

Still Images

Movies

You can tag images as favorites or assign them to My Category groups. By choosing a category in filtered playback, you can restrict the following operations to all of those images.

- Viewing (📖80), Viewing Slideshows (📖86), Protecting Images (📖87), Erasing Images (📖90), Adding Images to the Print List (DPOF) (📖126), Adding Images to a Photobook (📖128)

## Tagging Images as Favorites



- Press the <FUNC SET> button, and then choose [★] in the menu (📖25).
- [Tagged as Favorite] is displayed.
- To untag the image, repeat this process and choose [★] again, and then press the <FUNC SET> button.

Before Use

Basic Guide

Advanced Guide

Camera Basics

Using GPS Functions

Auto Mode

Other Shooting Modes

P Mode

Playback Mode

Setting Menu

Accessories

Appendix

Index



## Using the Menu

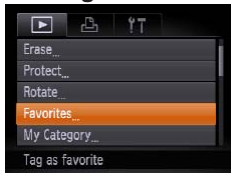

### 1 Choose [Favorites].

- Press the <MENU> button and choose [Favorites] on the [ ] tab (📖26).

### 2 Choose an image.

- Press the <◀>> buttons to choose an image, and then press the <FUNC SET> button. [★] is displayed.
- To untag the image, press the <FUNC SET> button again. [★] is no longer displayed.
- Repeat this process to choose additional images.

### 3 Finish the setup process.

- Press the <MENU> button. A confirmation message is displayed.
- Press the <◀>> buttons to choose [OK], and then press the <FUNC SET> button.



- Images will not be tagged as favorites if you switch to Shooting mode or turn the camera off before finishing the setup process in step 3.



- Favorite images will have a three-star rating (★★★☆☆) when transferred to computers running Windows 8, Windows 7, or Windows Vista. (Does not apply to movies.)

## Organizing Images by Category (My Category)

You can organize images into categories. Note that images are automatically categorized at the time of shooting, according to shooting conditions.

👤: Images with detected faces, or images shot in [ ] mode.

🌙: Images detected as [ ], [ ], or [ ] in [AUTO] mode, or images shot in [ ] mode.

📶: Images shot in [ ], [ ], [ ], or [ ] mode.



### 1 Choose a category.

- Press the <FUNC SET> button, and then choose [ ] in the menu (📖25).

### 2 Choose images.

- Press the <◀>> buttons to choose an image, press the <▲>>> buttons to choose a category, and then press the <FUNC SET> button. [✓] is displayed.
- To cancel selection, press the <FUNC SET> button again. [✓] is no longer displayed.
- Repeat this process to specify other images.

### 3 Finish the setup process.

- Press the <MENU> button. A confirmation message is displayed.
- Press the <◀>> buttons to choose [OK], and then press the <FUNC SET> button.

Before Use

Basic Guide

Advanced Guide

Camera Basics

Using GPS Functions

Auto Mode

Other Shooting Modes

P Mode

Playback Mode

Setting Menu

Accessories

Appendix

Index





- Images will not be assigned to a category if you switch to Shooting mode or turn the camera off before finishing the setup process in step 3.

## Using the Menu

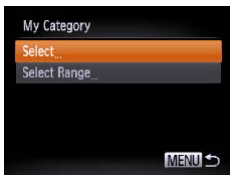

### 1 Access the setting screen.

- Press the <MENU> button, and then choose [My Category] on the [ ] tab (📖26).

### 2 Choose a selection method.

- Choose a menu item and an option as desired (📖26).
- To return to the menu screen, press the <MENU> button.

## Choosing Images Individually

### 1 Choose [Select].

- Following step 2 in “Using the Menu” (📖96), choose [Select] and press the <FUNC SET> button.

### 2 Choose an image.

- Press the <◀><▶> buttons to choose an image.



- Images will not be assigned to a category if you switch to Shooting mode or turn the camera off before finishing the setup process in step 4.

## Selecting a Range

### 3 Choose a category.

- Press the <▲><▼> buttons to choose a category and then press the <FUNC SET> button. [✓] is displayed.
- To cancel selection, press the <FUNC SET> button again. [✓] is no longer displayed.
- Repeat this process to choose additional images.

### 4 Finish the setup process.

- Press the <MENU> button. A confirmation message is displayed. Press the <◀><▶> buttons to choose [OK], and then press the <FUNC SET> button.

### 1 Choose [Select Range].

- Following step 2 in “Using the Menu” (📖96), choose [Select Range] and press the <FUNC SET> button.

### 2 Choose images.

- Follow steps 2 – 3 in “Selecting a Range” (📖89) to specify images.

Before Use

Basic Guide

Advanced Guide

Camera Basics

Using GPS  
Functions

Auto Mode

Other Shooting  
Modes

P Mode

Playback Mode

Setting Menu

Accessories

Appendix

Index







### 3 Choose a category.

- Press the <▼> button to choose the category options, and then press the <◀><▶> buttons to choose a category.

### 4 Finish the setup process.

- Press the <▼> button to choose [Select], and then press the <FUNC/SET> button.



- You can clear the selection of all images in the [Select Range] category by choosing [Deselect] in step 4.

## Editing Still Images



- Image editing (📖97 – 101) is only available when the memory card has sufficient free space.

Still Images

## Resizing Images

Save a copy of images at a lower resolution.

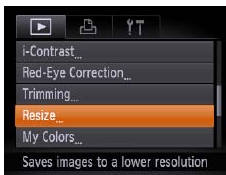

### 1 Choose [Resize].

- Press the <MENU> button and choose [Resize] on the [▶] tab (📖26).

### 2 Choose an image.

- Press the <◀><▶> buttons to choose an image, and then press the <FUNC/SET> button.

### 3 Choose an image size.

- Press the <◀><▶> buttons to choose the size, and then press the <FUNC/SET> button.
- [Save new image?] is displayed.



Before Use

Basic Guide

Advanced Guide

Camera Basics

Using GPS  
Functions

Auto Mode

Other Shooting  
Modes

P Mode

Playback Mode

Setting Menu

Accessories

Appendix

Index





#### 4 Save the new image.

- Press the <◀><▶> buttons to choose [OK], and then press the <FUNC SET> button.
- The image is now saved as a new file.



#### 5 Review the new image.

- Press the <MENU> button. [Display new image?] is displayed.
- Press the <◀><▶> buttons to choose [Yes], and then press the <FUNC SET> button.
- The saved image is now displayed.

! • Editing is not possible for images saved as [XS] in step 3.

✏ • Images cannot be resized to a higher resolution.

## Cropping

You can specify a portion of an image to save as a separate image file.

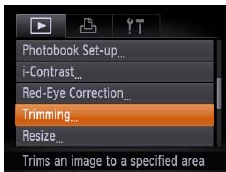

### 1 Choose [Trimming].

- Press the <MENU> button, and then choose [Trimming] on the [▶] tab (📖26).

### 2 Choose an image.

- Press the <◀><▶> buttons to choose an image, and then press the <FUNC SET> button.

### 3 Adjust the cropping area.

- A frame is displayed around the portion of the image to be cropped.
- The original image is shown in the upper left, and a preview of the image as cropped is shown in the lower right.
- To resize the frame, press the zoom buttons.
- To move the frame, press the <▲><▼><◀><▶> buttons.
- To change the frame orientation, press the <FUNC SET> button.
- Press the <MENU> button.

Cropping Area



Preview of Image  
After Cropping





#### 4 Save as a new image and review.

- Follow steps 4 – 5 in “Resizing Images” (📖98).

- ⚠ • Editing is not possible for images shot at a resolution of [S] (📖44) or resized to [XS] (📖97).

- ✎ • Images supported for cropping will have the same aspect ratio after cropping.
- Cropped images will have a lower resolution than uncropped images.

## Changing Image Color Tones (My Colors)

You can adjust image colors and then save the edited image as a separate file. For details on each option, see “Changing Image Color Tones (My Colors)” (📖70).



### 1 Choose [My Colors].

- Press the <MENU> button, and then choose [My Colors] on the [L] tab (📖26).

### 2 Choose an image.

- Press the <◀>>> buttons to choose an image, and then press the <FUNC/SET> button.

### 3 Choose an option.

- Press the <◀>>> buttons to choose an option, and then press the <FUNC/SET> button.

### 4 Save as a new image and review.

- Follow steps 4 – 5 in “Resizing Images” (📖98).

- ⚠ • Image quality of pictures you repeatedly edit this way will be a little lower each time, and you may not be able to obtain the desired color.





- The color of images edited using this function may vary slightly from the color of images shot using My Colors (📖70).

#### Still Images

## Correcting Image Brightness (i-Contrast)

Excessively dark image areas (such as faces or backgrounds) can be detected and automatically adjusted to the optimal brightness. Insufficient overall image contrast is also automatically corrected, to make subjects stand out better. Choose from four correction levels, and then save the image as a separate file.

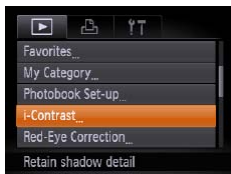

### 1 Choose [i-Contrast].

- Press the <MENU> button, and then choose [i-Contrast] on the [▶] tab (📖26).

### 2 Choose an image.

- Press the <<|>> buttons to choose an image, and then press the <FUNC SET> button.

### 3 Choose an option.

- Press the <<|>> buttons to choose an option, and then press the <FUNC SET> button.

### 4 Save as a new image and review.

- Follow steps 4 – 5 in “Resizing Images” (📖98).



- For some images, correction may be inaccurate or may cause images to appear grainy.
- Images may look grainy after repeated editing using this function.



- If [Auto] does not produce the expected results, try correcting images using [Low], [Medium], or [High].

#### Still Images

## Correcting Red-Eye

Automatically corrects images affected by red-eye. You can save the corrected image as a separate file.



### 1 Choose [Red-Eye Correction].

- Press the <MENU> button, and then choose [Red-Eye Correction] on the [▶] tab (📖26).

### 2 Choose an image.

- Press the <<|>> buttons to choose an image.

### 3 Correct the image.

- Press the <FUNC SET> button.
- Red-eye detected by the camera is now corrected, and frames are displayed around corrected image areas.
- Enlarge or reduce images as needed. Follow the steps in “Magnifying Images” (📖85).

Before Use

Basic Guide

Advanced Guide

Camera Basics

Using GPS Functions

Auto Mode

Other Shooting Modes

P Mode

Playback Mode

Setting Menu

Accessories

Appendix

Index





#### 4 Save as a new image and review.

- Press the <▲><▼><◀><▶> buttons to choose [New File], and then press the <FUNC/SET> button.
- The image is now saved as a new file.
- Follow step 5 in “Resizing Images” (p.98).



- Some images may not be corrected accurately.
- To overwrite the original image with the corrected image, choose [Overwrite] in step 4. In this case, the original image will be erased.
- Protected images cannot be overwritten.

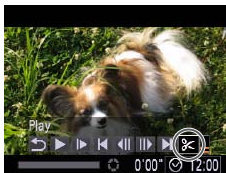

Movie Editing Panel



Movie Editing Bar

#### 1 Choose [⊗].

- Following steps 1 – 5 in “Viewing” (p.80), choose [⊗] and press the <FUNC/SET> button.
- The movie editing panel and editing bar are now displayed.

#### 2 Specify portions to cut.

- Press the <▲><▼> buttons to choose [⊗] or [⊗].
- To view the portions you can cut (identified by [⊗] on the screen), press the <◀><▶> buttons to move [⊗]. Cut the beginning of the movie (from [⊗]) by choosing [⊗], and cut the end of the movie by choosing [⊗].
- If you move [⊗] to a position other than a [⊗] mark, in [⊗] the portion before the nearest [⊗] mark on the left will be cut, while in [⊗] the portion after the nearest [⊗] mark on the right will be cut.

Before Use

Basic Guide

Advanced Guide

Camera Basics

Using GPS Functions

Auto Mode

Other Shooting Modes

P Mode

Playback Mode

Setting Menu

Accessories

Appendix

Index



### 3 Review the edited movie.

- Press the <▲><▼> buttons to choose [▶], and then press the <FUNC SET> button. The edited movie is now played.
- To edit the movie again, repeat step 2.
- To cancel editing, press the <▲><▼> buttons to choose [↶]. Press the <FUNC SET> button, press the <◀><▶> buttons to choose [OK], and then press the <FUNC SET> button again.

### 4 Save the edited movie.

- Press the <▲><▼> buttons to choose [▶], and then press the <FUNC SET> button.
- Press the <▲><▼><◀><▶> buttons to choose [New File], and then press the <FUNC SET> button.
- The movie is now saved as a new file.

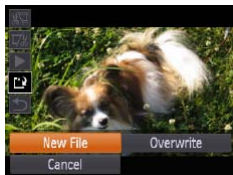

- To overwrite the original movie with the cut one, choose [Overwrite] in step 4. In this case, the original movie will be erased.
- If the memory card lacks sufficient space, only [Overwrite] will be available.
- Movies may not be saved if the battery pack runs out while saving is in progress.
- When editing movies, you should use a fully charged battery pack or an AC adapter kit (sold separately, 114).



# Setting Menu

Customize or adjust basic camera functions for greater convenience

<b>Adjusting Basic Camera Functions.....</b>	<b>104</b>	Date-Based Image Storage.....	108
Silencing Camera Operations .....	104	Power-Saving Adjustment.....	108
Adjusting the Volume .....	104	World Clock.....	109
Customizing Sounds .....	104	Date and Time.....	109
Hiding Hints and Tips .....	105	Activating GPS Features or Logging.....	109
Screen Brightness.....	105	Metric / Non-Metric Display .....	110
Start-up Screen .....	106	Display Language .....	110
Formatting Memory Cards .....	106	Restoring Defaults.....	110
File Numbering.....	108	Adjusting Other Settings .....	111

Before Use

Basic Guide

Advanced Guide

Camera Basics

Using GPS  
Functions

Auto Mode

Other Shooting  
Modes

P Mode

Playback Mode

Setting Menu

Accessories

Appendix

Index



## Adjusting Basic Camera Functions

MENU (📖26) functions on the [F/T] tab can be configured. Customize commonly used functions as desired, for greater convenience.

## Silencing Camera Operations

Silence camera sounds and movies as follows.



- Choose [Mute], and then choose [On].



- Operation can also be silenced by holding down the <◀> button as you turn the camera on.
- Sound is not played during movies (📖80) if you mute camera sounds. To restore sound during movies, press the <▶> button. Adjust volume with the <▲><▼> buttons, as needed.

## Adjusting the Volume

Adjust the volume of individual camera sounds as follows.



- Choose [Volume], and then press the <FUNC/SET> button.
- Choose an item, and then press the <◀><▶> buttons to adjust the volume.

## Customizing Sounds

Customize camera operating sounds as follows.



- Choose [Sound Options], and then press the <FUNC/SET> button.
- Choose an item, and then press the <◀><▶> buttons to choose an option.

Before Use

Basic Guide

Advanced Guide

Camera Basics

Using GPS  
Functions

Auto Mode

Other Shooting  
Modes

P Mode

Playback Mode

Setting Menu

Accessories

Appendix

Index





## Hiding Hints and Tips

Hints and tips are normally shown when you choose FUNC. (📖25) or MENU (📖26) items. If you prefer, you can deactivate this information.

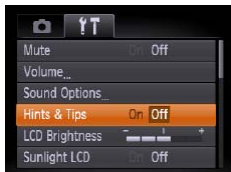

- Choose [Hints & Tips], and then choose [Off].

## Screen Brightness

Adjust screen brightness as follows.



- Choose [LCD Brightness], and then press the <◀> buttons to adjust the brightness.

## Increasing Screen Brightness

Screen brightness can be increased to a level even brighter than the highest level in [LCD Brightness].



- Choose [Sunlight LCD], and then choose [On].



- Activating [Sunlight LCD] mode overrides the [LCD Brightness] setting.
- You can also access [Sunlight LCD] mode by holding the <▼> button for at least one second when the shooting screen is displayed or when in single-image display. To restore the original brightness, press and hold the <▼> button again for at least one second.

Before Use

Basic Guide

Advanced Guide

Camera Basics

Using GPS Functions

Auto Mode

Other Shooting Modes

P Mode

Playback Mode

Setting Menu

Accessories

Appendix

Index



## Start-up Screen

Customize the start-up screen shown after you turn the camera on as follows.



- Choose [Start-up Image], and then press the  button.
- Press the   buttons to choose an option.

OFF	No start-up image
1	Preset image (Cannot be modified.)
2	Preset image Otherwise, you can assign a desired shot.





## Customizing the Start-up Screen



- 1 Access the [Start-up Image] screen in Playback mode.**
  - Press the  button.
  - Following the previous procedure, choose [2] and press the  button.



## 2 Choose one of your shots.

- Choose an image and press the  button. After [Register?] is displayed, press the   buttons to choose [OK], and then press the  button.

-  • The previous start-up option is overwritten when you assign a new start-up image.

## Formatting Memory Cards

Before using a new memory card or a card formatted in another device, you should format the card with this camera.

Formatting erases all data on a memory card. Before formatting, copy images on the memory card to a computer, or take other steps to back them up.

An Eye-Fi card ( 130) contains software on the card itself. Before formatting an Eye-Fi card, install the software on a computer.

## 1 Access the [Format] screen.

- Choose [Format], and then press the  button.

Before Use

Basic Guide

Advanced Guide

Camera Basics

Using GPS  
Functions

Auto Mode

Other Shooting  
Modes

P Mode

Playback Mode

Setting Menu

Accessories

Appendix

Index



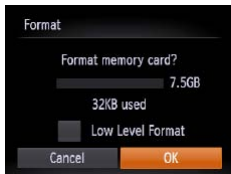

## 2 Choose [OK].

- Press the <▲><▼> buttons to choose [Cancel], press the <◀><▶> buttons to choose [OK], and then press the <FUNC SET> button.

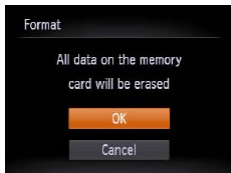

## 3 Format the memory card.

- To begin the formatting process, press the <▲><▼> buttons to choose [OK], and then press the <FUNC SET> button.
- When formatting is finished, [Memory card formatting complete] is displayed. Press the <FUNC SET> button.



- Formatting or erasing data on a memory card only changes file management information on the card and does not erase the data completely. When transferring or disposing of memory cards, take steps to protect personal information if necessary, as by physically destroying cards.



- The total card capacity indicated on the formatting screen may be less than the advertised capacity.

## Low-Level Formatting

Perform low-level formatting in the following cases: [Memory card error] is displayed, the camera is not working correctly, card image reading/writing is slower, continuous shooting is slower, or movie recording suddenly stops. Low-level formatting erases all data on a memory card. Before low-level formatting, copy images on the memory card to a computer, or take other steps to back them up.

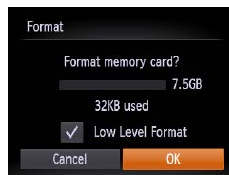

- On the screen in step 2 of “Formatting Memory Cards” (📖107), press the <▲><▼> buttons to choose [Low Level Format], and then press the <◀><▶> buttons to select this option. A [✓] icon is displayed.
- Follow steps 2 – 3 in “Formatting Memory Cards” (📖107) to continue with the formatting process.



- Low-level formatting takes longer than “Formatting Memory Cards” (📖106), because data is erased from all storage regions of the memory card.
- You can cancel low-level formatting in progress by choosing [Stop]. In this case, all data will be erased, but the memory card can be used normally.

Before Use

Basic Guide

Advanced Guide

Camera Basics

Using GPS Functions

Auto Mode

Other Shooting Modes

P Mode

Playback Mode

Setting Menu

Accessories

Appendix

Index



## File Numbering

Your shots are automatically numbered in sequential order (0001 – 9999) and saved in folders that store up to 2,000 images each. You can change how the camera assigns file numbers.



- Choose [File Numbering], and then choose an option.

Continuous	Images are numbered consecutively (until the 9999th shot is taken/saved) even if you switch memory cards.
Auto Reset	Image numbering is reset to 0001 if you switch memory cards, or when a new folder is created.



- Regardless of the option selected in this setting, shots may be numbered consecutively after the last number of existing images on newly inserted memory cards. To start saving shots from 0001, use an empty (or formatted (106)) memory card.
- Refer to “Software Instruction Manual” (119) for information on the card folder structure and image formats.

## Date-Based Image Storage

Instead of saving images in folders created each month, you can have the camera create folders each day you shoot to store shots taken that day.



- Choose [Create Folder], and then choose [Daily].
- Images will now be saved in folders created on the shooting date.

## Power-Saving Adjustment

Adjust the timing of automatic camera and screen deactivation (Auto Power Down and Display Off, respectively) as needed (23).



- Choose [Power Saving], and then press the <PUSH SET> button.
- After choosing an item, press the <◀>>> buttons to adjust it as needed.



- To conserve battery power, you should normally choose [On] for [Auto Power Down] and [1 min.] or less for [Display Off].



- The [Display Off] setting is applied even if you set [Auto Power Down] to [Off].

Before Use

Basic Guide

Advanced Guide

Camera Basics

Using GPS Functions

Auto Mode

Other Shooting Modes

P Mode

Playback Mode

Setting Menu

Accessories

Appendix

Index



## World Clock

To ensure that your shots will have the correct local date and time when you travel abroad, simply register the destination in advance and switch to that time zone. This convenient feature eliminates the need to change the Date/Time setting manually.

Before using the world clock, be sure to set the date and time and your home time zone, as described in “Setting the Date and Time” (📖15).

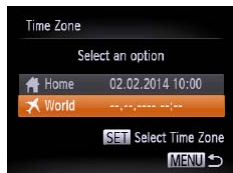

### 1 Specify your destination.

- Choose [Time Zone], and then press the  $\langle \text{FUNC SET} \rangle$  button.
- Press the  $\langle \blacktriangle \rangle \langle \blacktriangledown \rangle$  buttons to choose [ $\blacktriangle$  World], and then press the  $\langle \text{FUNC SET} \rangle$  button.
- Press the  $\langle \blacktriangle \rangle \langle \blacktriangledown \rangle$  buttons to choose the destination.
- To set daylight saving time (1 hour ahead), press the  $\langle \blacktriangle \rangle \langle \blacktriangledown \rangle$  buttons to choose [ $\blacktriangle$ ].
- Press the  $\langle \text{FUNC SET} \rangle$  button.

### 2 Switch to the destination time zone.

- Press the  $\langle \blacktriangle \rangle \langle \blacktriangledown \rangle$  buttons to choose [ $\blacktriangle$  World], and then press the  $\langle \text{MENU} \rangle$  button.
- [ $\blacktriangle$ ] is now shown on the shooting screen (📖137).

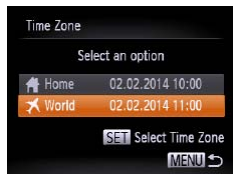

- Adjusting the date or time while in [ $\blacktriangle$ ] mode (📖16) will automatically update your [ $\blacktriangle$  Home] time and date.

## Date and Time

Adjust the date and time as follows.



- Choose [Date/Time], and then press the  $\langle \text{FUNC SET} \rangle$  button.
- Press the  $\langle \blacktriangle \rangle \langle \blacktriangledown \rangle$  buttons to choose an option, and then press the  $\langle \blacktriangle \rangle \langle \blacktriangledown \rangle$  buttons to adjust the setting.

## Activating GPS Features or Logging

GPS features and logging can be activated as follows. For instructions after activating these features, see “Using GPS Functions” (📖30).



- Choose [GPS Settings], and then press the  $\langle \text{FUNC SET} \rangle$  button.
- To activate GPS features, choose [GPS], and then choose [On].
- To activate logging, first activate GPS as described above, choose [GPS Logger], and then choose [On].
- When you press the  $\langle \text{MENU} \rangle$  button, a message about GPS and logging is displayed. Press the  $\langle \text{FUNC SET} \rangle$  button after reading the message.

Before Use

Basic Guide

Advanced Guide

Camera Basics

Using GPS Functions

Auto Mode

Other Shooting Modes

P Mode

Playback Mode

Setting Menu

Accessories

Appendix

Index



## Metric / Non-Metric Display

Change the unit of measurement shown in GPS elevation information (📖30), the zoom bar (📖35), the MF indicator (📖72), and elsewhere from m/cm to ft/in as needed.

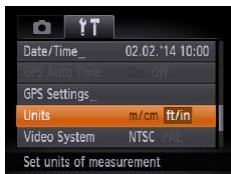

- Choose [Units], and then choose [ft/in].

## Display Language

Change the display language as needed.



- Choose [Language], and then press the <FUNC SET> button.
- Press the <▲><▼><◀><▶> buttons to choose a language, and then press the <FUNC SET> button.

- You can also access the [Language] screen in Playback mode by pressing and holding the <FUNC SET> button and immediately pressing the <MENU> button.

## Restoring Defaults

If you accidentally change a setting, you can restore default camera settings.



### 1 Access the [Reset All] screen.

- Choose [Reset All], and then press the <FUNC SET> button.

### 2 Restore default settings.

- Press the <◀><▶> buttons to choose [OK], and then press the <FUNC SET> button.
- Default settings are now restored.



- The following functions are not restored to default settings.
  - [↑↓] tab settings for the image assigned to [Start-up Image] (📖106), [Date/Time] (📖109), [Time Zone] (📖109), [Language] (📖110), and [Video System] (📖117).
  - Custom white balance data you have recorded (📖70)
  - Colors chosen in Color Accent (📖57) or Color Swap (📖58)
  - Shooting mode (📖51)

Before Use

Basic Guide

Advanced Guide

Camera Basics

Using GPS Functions

Auto Mode

Other Shooting Modes

P Mode

Playback Mode

Setting Menu

Accessories

Appendix

Index



## Adjusting Other Settings

The following settings can also be adjusted on the **[F1]** tab.

- [GPS Auto Time] (133)
- [GPS Settings] > [Display Log Files] (32)
- [Video System] (117)
- [Ctrl via HDMI] (116)
- [Eye-Fi Settings] (130)

Before Use

Basic Guide

Advanced Guide

Camera Basics

Using GPS  
Functions

Auto Mode

Other Shooting  
Modes

P Mode

Playback Mode

Setting Menu

Accessories

Appendix

Index



# Accessories

Enjoy the camera in more ways with optional Canon accessories and other compatible accessories sold separately

<b>System Map</b> .....	<b>113</b>	<b>Using the Software</b> .....	<b>119</b>	<b>Using an Eye-Fi Card</b> .....	<b>130</b>
<b>Optional Accessories</b> .....	<b>114</b>	Software .....	119	Checking Connection Information .....	130
Power Supplies .....	114	Checking Your Computer Environment .....	120	Disabling Eye-Fi Transfer .....	131
Flash Unit .....	114	Installing the Software .....	120		
Other Accessories .....	114	Saving Images to a Computer .....	121		
Printers .....	115	<b>Printing Images</b> .....	<b>122</b>		
<b>Using Optional Accessories</b> .....	<b>115</b>	Easy Print .....	122		
Playback on a TV .....	115	Configuring Print Settings .....	123		
Powering the Camera with Household Power.....	118	Printing Movie Scenes .....	125		
Using the Silicone Jacket .....	118	Adding Images to the Print List (DPOF) .....	126		
Using the Float .....	119	Adding Images to a Photobook .....	128		

Before Use

Basic Guide

Advanced Guide

Camera Basics

Using GPS  
Functions

Auto Mode

Other Shooting  
Modes

P Mode

Playback Mode

Setting Menu

Accessories

Appendix

Index





# System Map

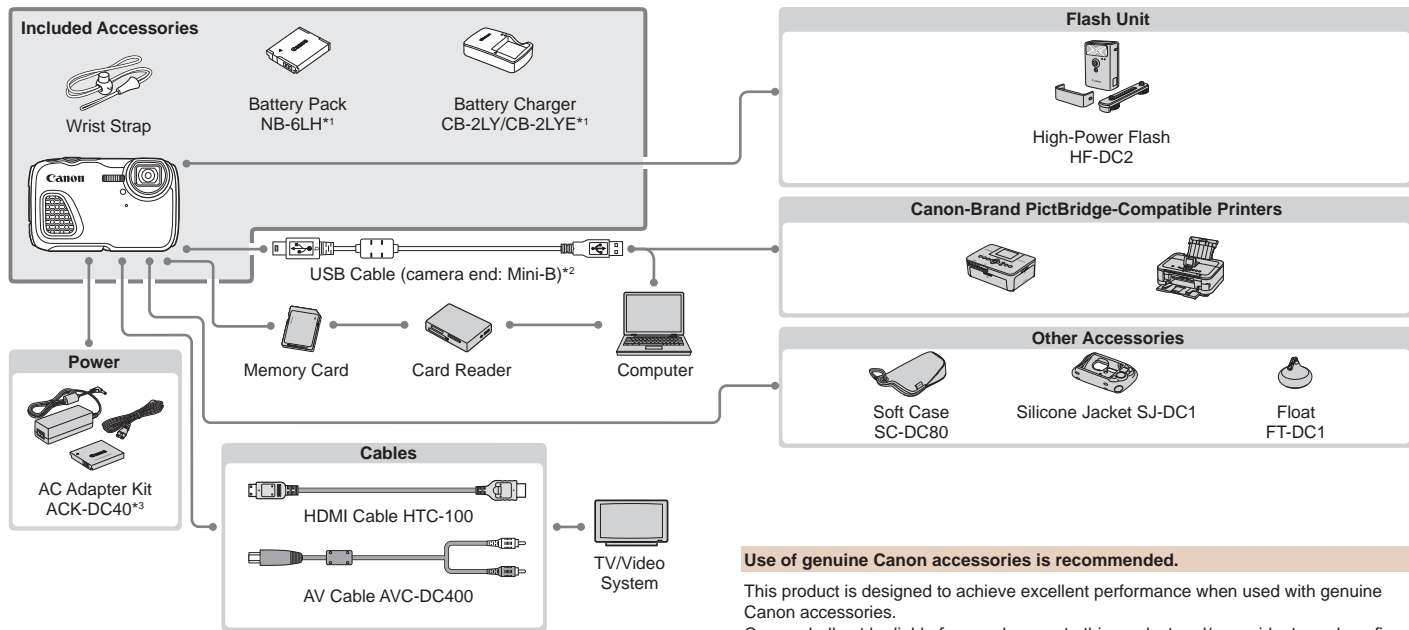

\*1 Also available for purchase separately.

\*2 A genuine Canon accessory is also available (Interface Cable IFC-400PCU).

\*3 The included DC coupler is not used.

## Use of genuine Canon accessories is recommended.

This product is designed to achieve excellent performance when used with genuine Canon accessories.

Canon shall not be liable for any damage to this product and/or accidents such as fire, etc., caused by the malfunction of non-genuine Canon accessories (e.g., a leakage and/or explosion of a battery pack). Please note that this warranty does not apply to repairs arising out of the malfunction of non-genuine Canon accessories, although you may request such repairs on a chargeable basis.

Note that availability varies by area, and some accessories may no longer be available.

Before Use

Basic Guide

Advanced Guide

Camera Basics

Using GPS Functions

Auto Mode

Other Shooting Modes

P Mode

Playback Mode

Setting Menu

Accessories

Appendix

Index



## Optional Accessories

The following camera accessories are sold separately. Note that availability varies by area, and some accessories may no longer be available.

### Power Supplies

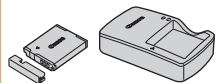

#### Battery Pack NB-6LH

- Rechargeable lithium-ion battery

#### Battery Charger CB-2LY/CB-2LYE

- Charger for Battery Pack NB-6LH



- The battery pack includes a convenient cover which you can attach to know the charging status at a glance. Attach the cover so that ▲ is visible on a charged battery pack, and attach it so that ▲ is not visible on an uncharged battery pack.
- Battery Pack NB-6L is also supported.

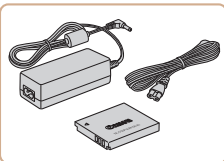

#### AC Adapter Kit ACK-DC40

- For powering the camera using household power. Recommended when using the camera over extended periods, or when connecting the camera to a printer or computer. Cannot be used to charge the battery pack in the camera.



- The DC coupler included with AC Adapter Kit ACK-DC40 is not used.
- In addition to AC Adapter Kit ACK-DC40, these accessories can also be used with the camera: ACK-DC10, ACK-DC30, ACK-DC60, ACK-DC70, ACK-DC80, and ACK-DC90.



- The battery charger and AC adapter kit can be used in areas with 100 – 240 V AC power (50/60 Hz).
- For power outlets in a different format, use a commercially available adapter for the plug. Never use an electrical transformer designed for traveling, which may damage the battery pack.

### Flash Unit



#### High-Power Flash HF-DC2

- External flash for illuminating subjects that are out of range of the built-in flash. High-Power Flash HF-DC1 can also be used.

### Other Accessories

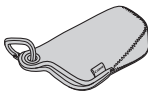

#### Soft Case SC-DC80

- Protects the camera from dust and scratches.

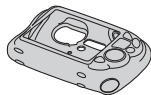

#### Silicone Jacket SJ-DC1

- The jacket protects the camera from scratches. It is also submersible and can be used in seawater.



#### Float FT-DC1

- Prevents the camera from sinking when used in water.
- Can be used at depths of up to 10 m (33 ft.).

Before Use

Basic Guide

Advanced Guide

Camera Basics

Using GPS Functions

Auto Mode

Other Shooting Modes

P Mode

Playback Mode

Setting Menu

Accessories

Appendix

Index



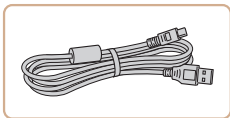

### Interface Cable IFC-400PCU

- For connecting the camera to a computer or printer.

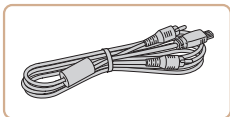

### AV Cable AVC-DC400

- Connect the camera to a TV to enjoy playback on the larger TV screen.

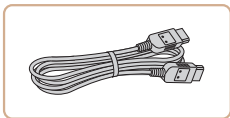

### HDMI Cable HTC-100

- For connecting the camera to an HDMI input of a high-definition TV.

## Printers

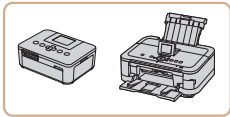

### Canon-Brand PictBridge-Compatible Printers

- Printing images without a computer is possible by connecting the camera to a Canon-brand PictBridge-compatible printer. For details, visit your nearest Canon retailer.

## Using Optional Accessories

Still Images

Movies

### Playback on a TV

Still Images

Movies

By connecting the camera to a TV, you can view your shots on the larger screen of the TV. For details on connection or how to switch inputs, refer to the TV manual.



- Some information may not be displayed on the TV (📖138).

Still Images

Movies

### Playback on a High-Definition TV

Connecting the camera to an HDTV with the HDMI Cable HTC-100 (sold separately) enables you to view your shots on the larger screen of the TV. Movies shot at a resolution of [1920] or [1080] can be viewed in high definition.

**1 Make sure the camera and TV are off.**

**2 Connect the camera to the TV.**

- On the TV, insert the cable plug fully into the HDMI input as shown.

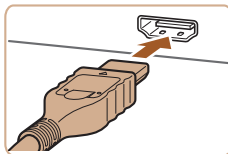

Before Use

Basic Guide

Advanced Guide

Camera Basics

Using GPS Functions

Auto Mode

Other Shooting Modes

P Mode

Playback Mode

Setting Menu

Accessories

Appendix

Index



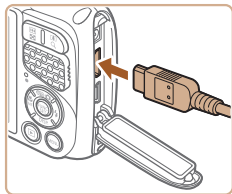

- On the camera, open the terminal cover and insert the cable plug fully into the camera terminal.

### 3 Turn the TV on and switch to video input.

- Switch the TV input to the video input you connected the cable to in step 2.

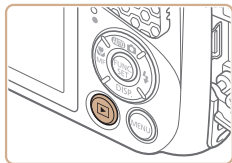

### 4 Turn the camera on.

- Press the <▶> button to turn the camera on.
- Images from the camera are now displayed on the TV. (Nothing is displayed on the camera screen.)
- When finished, turn off the camera and TV before disconnecting the cable.



- Camera operating sounds are not played while the camera is connected to an HDTV.

## ■ Controlling the Camera with a TV Remote

Connecting the camera to an HDMI CEC-compatible TV enables playback (including slideshow playback) using the TV remote control. Depending on the TV, you may need to adjust some TV settings. For details, refer to the TV manual.

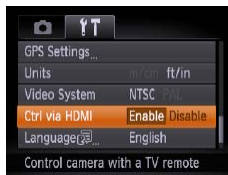

### 1 Configure the setting.

- Press the <MENU> button, choose [Ctrl via HDMI] on the [↑↑] tab, and then choose [Enable] (📖26).

### 2 Connect the camera to the TV.

- Follow steps 1 – 2 in “Playback on a High-Definition TV” (📖115) to connect the camera to the TV.

### 3 Display images.





- Turn on the TV. On the camera, press the <▶> button.
- Images from the camera are now displayed on the TV. (Nothing is displayed on the camera screen.)



#### 4 Control the camera with the TV remote.

- Press the <<|>> buttons on the remote to browse images.
- To display the camera control panel, press the OK/Select button. Select control panel options by pressing the <<|>> buttons to choose an option, and then pressing the OK/Select button again.

#### ■ Camera Control Panel Options Shown on the TV

	Return	Closes the menu.
	Play Movie	Starts movie playback. (Only displayed when a movie is selected.)
	Slideshow	Starts slideshow playback. To switch images during playback, press the << >> buttons on the remote control.
	Index Playback	Displays multiple images in an index.
DISP.	Change Display	Switches display modes (📖82).



- Pressing buttons, such as the <MENU> button, on the camera will switch control to the camera itself, which will prevent remote control until you return to single-image display.
- The camera may not always respond correctly even if the remote is for an HDMI CEC-compatible TV.

#### ■ Playback on a Standard-Definition TV

Connecting the camera to a TV with the AV Cable AVC-DC400 (sold separately) enables you to view your shots on the larger screen of the TV as you control the camera.

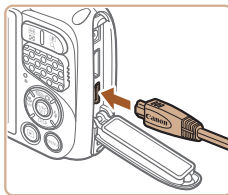
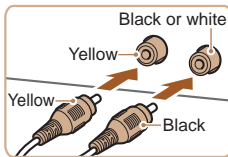

#### 1 Make sure the camera and TV are off.

#### 2 Connect the camera to the TV.

- On the TV, insert the cable plugs fully into the video inputs as shown.
- On the camera, open the terminal cover and insert the cable plug fully into the camera terminal.

#### 3 Display images.

- Follow steps 3 – 4 in “Playback on a High-Definition TV” (📖116) to display images.



- Correct display is not possible unless the camera video output format (NTSC or PAL) matches the TV format. To change the video output format, press the <MENU> button and choose [Video System] on the [↑↑] tab.





- When the camera and TV are connected, you can also shoot while previewing shots on the larger screen of the TV. To shoot, follow the same steps as when using the camera screen. However, AF-Point Zoom (📖46), Stitch Assist (📖63) and MF-Point Zoom (📖72) are not available.

Still Images

Movies

## Powering the Camera with Household Power

Powering the camera with AC Adapter Kit ACK-DC40 (sold separately) eliminates the need to monitor the remaining battery level.

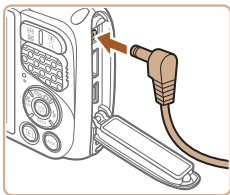

### 1 Make sure the camera is off.

### 2 Connect the adapter to the camera.

- Open the cover and insert the adapter plug fully into the camera.

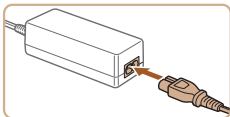

### 3 Connect the power cord.

- Insert one end of the power cord into the compact power adapter, and then plug the other end into a power outlet.
- Turn the camera on and use it as desired.
- When finished, turn the camera off and unplug the power cord from the outlet.



- Do not disconnect the adapter or unplug the power cord while the camera is still on. This may erase your shots or damage the camera.
- Do not attach the adapter or adapter cord to other objects. Doing so could result in malfunction or damage to the product.

## Using the Silicone Jacket

Putting the camera in Silicone Jacket SJ-DC1 (sold separately) protects it from scratches. The jacket is submersible and can be used in seawater.



- Insert the camera in the jacket in the direction of the arrow.
- To avoid scratching the camera, keep dust and sand out of the jacket.



- Be careful when inserting and removing the camera from the jacket. Do not force it open, which may tear or damage it.
- To avoid scratching the camera, always remove any dust or sand that gets in the jacket.
- After using the jacket in salt water or in dusty or sandy environments, rinse it thoroughly under fresh water (such as tap water) no warmer than 30 °C (86 °F) and dry it with a soft cloth.

Before Use

Basic Guide

Advanced Guide

Camera Basics

Using GPS  
Functions

Auto Mode

Other Shooting  
Modes

P Mode

Playback Mode

Setting Menu

Accessories

Appendix

Index



## Using the Float

Attaching Float FT-DC1 (sold separately) prevents the camera from sinking in water. Can be used at depths of up to 10 m (33 ft.).

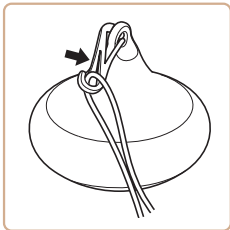

- Attach the float as shown to the end of the wrist strap included with the camera.



- Do not squeeze or scratch the float, which may reduce its buoyancy.



- After use, rinse the float thoroughly under fresh water (such as tap water) no warmer than 30 °C (86 °F) and dry it with a soft cloth.

## Using the Software

The software available for download from the Canon website is introduced below, with instructions for installation and saving images to a computer.

### Software

After downloading the software from the Canon website and installing it, you can do the following things on your computer.

#### CameraWindow

- Import images and change camera settings

#### ImageBrowser EX

- Manage images: view, search, and organize
- Print and edit images



- Internet access is required, and any ISP account charges and access fees must be paid separately.

#### Software Instruction Manual

Refer to the instruction manual when using the software. The manual can be accessed from the help system of software (some software excluded).

Before Use

Basic Guide

Advanced Guide

Camera Basics

Using GPS Functions

Auto Mode

Other Shooting Modes

P Mode

Playback Mode

Setting Menu

Accessories

Appendix

Index



## Checking Your Computer Environment

The software can be used on the following computers. For detailed system requirements and compatibility information, including support in new operating systems, visit the Canon website.

Operating System*	Windows	Mac OS
	Windows 8/8.1	Mac OS X 10.9
Windows 7 SP1	Mac OS X 10.8	
Windows Vista SP2	Mac OS X 10.7	
Windows XP SP3		



- Check the Canon website for the latest system requirements, including supported OS versions.

## Installing the Software

Windows 7 and Mac OS X 10.8 are used here for the sake of illustration.

### 1 Download the software.

- With a computer connected to the Internet, access <http://www.canon.com/icpd/>.
- Access the site for your country or region.
- Download the software.

### 2 Install the files.

- Click [Easy Installation] and follow the on-screen instructions to complete the installation process.
- Installation may take some time, depending on computer performance and the Internet connection.
- Click [Finish] or [Restart] on the screen after installation.



Before Use

Basic Guide

Advanced Guide

Camera Basics

Using GPS Functions

Auto Mode

Other Shooting Modes

P Mode

Playback Mode

Setting Menu

Accessories

Appendix

Index





## Saving Images to a Computer

Windows 7 and Mac OS X 10.8 are used here for the sake of illustration. For other functions, refer to the help system of the relevant software (some software excluded).

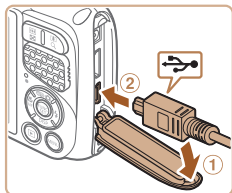

### 1 Connect the camera to the computer.

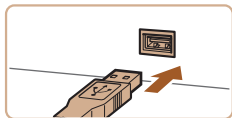

- With the camera turned off, open the cover (1). With the smaller plug of the USB cable in the orientation shown, insert the plug fully into the camera terminal (2).

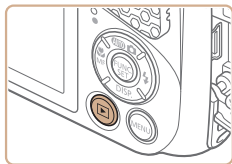

- Insert the larger plug of the USB cable in the computer's USB port. For details about USB connections on the computer, refer to the computer user manual.



### 2 Turn the camera on to access CameraWindow.

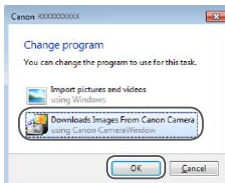

- Press the  button to turn the camera on.
- Mac OS: CameraWindow is displayed when a connection is established between the camera and computer.
- Windows: Follow the steps introduced below.
- In the screen that displays, click the  link to modify the program.



- Choose [Downloads Images From Canon Camera] and then click [OK].

- Double-click .

### 3 Save the images to the computer.

- Click [Import Images from Camera], and then click [Import Untransferred Images].
- Images are now saved to the Pictures folder on the computer, in separate folders named by date.
- After images are saved, close CameraWindow, press the  button to turn the camera off, and unplug the cable.
- For instructions on viewing images on a computer, refer to "Software Instruction Manual" ( 119).

Before Use

Basic Guide

Advanced Guide

Camera Basics

Using GPS Functions

Auto Mode

Other Shooting Modes

P Mode

Playback Mode

Setting Menu

Accessories

Appendix

Index





- Windows 7: If the screen in step 2 is not displayed, click the [ ] icon in the taskbar.
- Windows Vista or XP: To start CameraWindow, click [Downloads Images From Canon Camera] on the screen displayed when you turn the camera on in step 2. If CameraWindow is not displayed, click the [Start] menu and choose [All Programs] ► [Canon Utilities] ► [CameraWindow] ► [CameraWindow].
- Mac OS: If CameraWindow is not displayed after step 2, click the [CameraWindow] icon in the Dock.
- Although you can save images to a computer simply by connecting your camera to the computer without using the software, the following limitations apply.
  - It may take a few minutes after you connect the camera to the computer until camera images are accessible.
  - Images shot in vertical orientation may be saved in horizontal orientation.
  - Image protection settings may be cleared from images saved to a computer.
  - Some problems may occur when saving images or image information, depending on the operating system version, the software in use, or image file sizes.
  - GPS log files ( [ ] 31 ) may not be saved correctly.
  - Some functions provided by the software may not be available, such as movie editing.

## Printing Images

Your shots can easily be printed by connecting the camera to a printer. On the camera, you can specify images to set up batch printing, prepare orders for photo development services, and prepare orders or print images for photobooks.

A Canon SELPHY CP series compact photo printer is used here for the sake of illustration. Screens displayed and available functions vary by printer. Also refer to the printer manual for additional information.

### Easy Print

Easily print your shots by connecting the camera to a PictBridge-compatible printer (sold separately) with the USB cable.

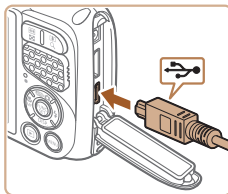

#### 1 Make sure the camera and printer are off.

#### 2 Connect the camera to the printer.

- Open the cover. Holding the smaller cable plug in the orientation shown, insert the plug fully into the camera terminal.
- Connect the larger cable plug to the printer. For other connection details, refer to the printer manual.

Still Images

Movies

Before Use

Basic Guide

Advanced Guide

Camera Basics

Using GPS Functions

Auto Mode

Other Shooting Modes

P Mode

Playback Mode

Setting Menu

Accessories

Appendix

Index



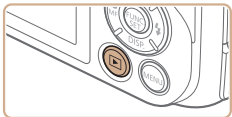

### 3 Turn the printer on.

### 4 Turn the camera on.

- Press the button to turn the camera on.

### 5 Choose an image.

- Press the buttons to choose an image.

### 6 Access the printing screen.

- Press the button, choose , and press the button again.

### 7 Print the image.

- Press the buttons to choose [Print], and then press the button.
- Printing now begins.
- To print other images, repeat the above procedures starting from step 5 after printing is finished.
- When you are finished printing, turn the camera and printer off and disconnect the cable.

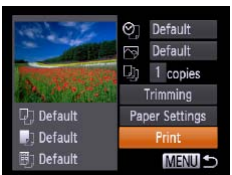
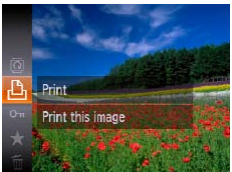

- For Canon-brand PictBridge-compatible printers (sold separately), see "Printers" (115).

## Configuring Print Settings



### 1 Access the printing screen.

- Follow steps 1 – 6 in "Easy Print" (122 – 123) to access the screen at left.

### 2 Configure the settings.

- Press the buttons to choose an item, and then press the buttons to choose an option.

	Default	Matches current printer settings.
	Date	Prints images with the date added.
	File No.	Prints images with the file number added.
	Both	Prints images with both the date and file number added.
	Off	–
	Default	Matches current printer settings.
	Off	–
	On	Uses information from the time of shooting to print under optimal settings.
	Red-Eye 1	Corrects red-eye.
	No. of Copies	Choose the number of copies to print.
<b>Trimming</b>	–	Specify a desired image area to print (124).
<b>Paper Settings</b>	–	Specify the paper size, layout, and other details (124).



## Cropping Images before Printing

By cropping images before printing, you can print a desired image area instead of the entire image.



### 1 Choose [Trimming].

- After following step 1 in “Configuring Print Settings” (📖123) to access the printing screen, choose [Trimming] and press the  $\langle \text{FUNC SET} \rangle$  button.
- A cropping frame is now displayed, indicating the image area to print.

### 2 Adjust the cropping frame as needed.

- To resize the frame, press the zoom buttons.
- To move the frame, press the  $\langle \blacktriangle \rangle \langle \blacktriangledown \rangle \langle \blacktriangleleft \rangle \langle \blacktriangleright \rangle$  buttons.
- To rotate the frame, press the  $\langle \text{FUNC SET} \rangle$  button.
- Press the  $\langle \text{MENU} \rangle$  button, press the  $\langle \blacktriangle \rangle \langle \blacktriangledown \rangle$  buttons to choose [OK], and then press the  $\langle \text{FUNC SET} \rangle$  button.

### 3 Print the image.

- Follow step 7 in “Easy Print” (📖123) to print.



- Cropping may not be possible at small image sizes, or at some aspect ratios.
- Dates may not be printed correctly if you crop images shot with [Date Stamp] selected.



## Choosing Paper Size and Layout before Printing



### 1 Choose [Paper Settings].

- After following step 1 in “Configuring Print Settings” (📖123) to access the printing screen, choose [Paper Settings] and press the  $\langle \text{FUNC SET} \rangle$  button.

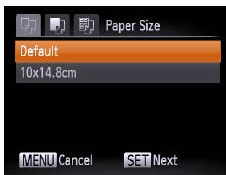

### 2 Choose a paper size.

- Press the  $\langle \blacktriangle \rangle \langle \blacktriangledown \rangle$  buttons to choose an option, and then press the  $\langle \text{FUNC SET} \rangle$  button.

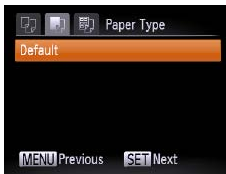

### 3 Choose a type of paper.

- Press the  $\langle \blacktriangle \rangle \langle \blacktriangledown \rangle$  buttons to choose an option, and then press the  $\langle \text{FUNC SET} \rangle$  button.



### 4 Choose a layout.

- Press the  $\langle \blacktriangle \rangle \langle \blacktriangledown \rangle$  buttons to choose an option.
- When choosing [N-up], press the  $\langle \blacktriangleleft \rangle \langle \blacktriangleright \rangle$  buttons to specify the number of images per sheet.
- Press the  $\langle \text{FUNC SET} \rangle$  button.

### 5 Print the image.



## Available Layout Options

Default	Matches current printer settings.
Bordered	Prints with blank space around the image.
Borderless	Borderless, edge-to-edge printing.
N-up	Choose how many images to print per sheet.
ID Photo	Prints images for identification purposes. Only available for images with a resolution of L and an aspect ratio of 4:3.
Fixed Size	Choose the print size. Choose from 3.5 x 5 in., postcard, or wide-format prints.

## Printing ID Photos

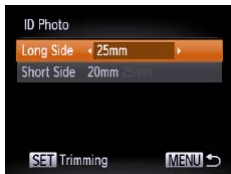

### 1 Choose [ID Photo].

- Following steps 1 – 4 in “Choosing Paper Size and Layout before Printing” (124), choose [ID Photo] and press the **FUNC/SET** button.

### 2 Choose the long and short side length.

- Press the **<▲>**/**<▼>** buttons to choose an item. Choose the length by pressing the **<◀>**/**<▶>** buttons, and then press the **FUNC/SET** button.

Still Images



### 3 Choose the printing area.

- Follow step 2 in “Cropping Images before Printing” (124) to choose the printing area.

### 4 Print the image.

## Printing Movie Scenes

Movies

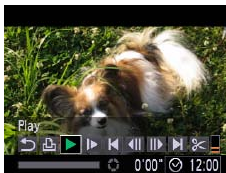

### 1 Access the printing screen.

- Follow steps 1 – 6 in “Easy Print” (122 – 123) to choose a movie. The screen at left is displayed.

### 2 Choose a printing method.

- Press the **<▲>**/**<▼>** buttons to choose [**Print**], and then press the **<◀>**/**<▶>** buttons to choose the printing method.

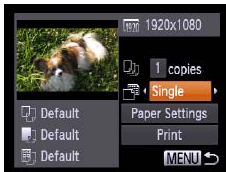

### 3 Print the image.

Before Use

Basic Guide

Advanced Guide

Camera Basics

Using GPS Functions

Auto Mode

Other Shooting Modes

P Mode

Playback Mode

Setting Menu

Accessories

Appendix

Index



## Movie Printing Options

Single	Prints the current scene as a still image.
Sequence	Prints a series of scenes, a certain interval apart, on a single sheet of paper. You can also print the folder number, file number, and elapsed time for the frame by setting [Caption] to [On].



- To cancel printing in progress, press the  $\langle \text{FUNC SET} \rangle$  button.
- [ID Photo] and [Sequence] cannot be chosen on Canon-brand PictBridge-compatible printers from CP720/CP730 and earlier models.

### Still Images

## Adding Images to the Print List (DPOF)

Batch printing (📖 128) and ordering prints from a photo development service can be set up on the camera. Choose up to 998 images on a memory card and configure relevant settings, such as the number of copies, as follows. The printing information you prepare this way will conform to DPOF (Digital Print Order Format) standards.

### Adding Images to the Print List via the FUNC. Menu

You can add images to the print list (DPOF) after your shot or later during playback via the FUNC. menu.

#### 1 Choose an image.

- Press the  $\langle \blacktriangleleft \blacktriangleright \rangle$  buttons to choose an image.

#### 2 Add the image to the print list.

- Press the  $\langle \text{FUNC SET} \rangle$  button, choose [D] in the menu, and press the  $\langle \text{FUNC SET} \rangle$  button again.
- Press the  $\langle \blacktriangle \blacktriangledown \rangle$  buttons to specify the number of prints. Choose [Add] by pressing the  $\langle \blacktriangleleft \blacktriangleright \rangle$  buttons, and then press the  $\langle \text{FUNC SET} \rangle$  button.



## Configuring Print Settings

Specify the printing format, whether to add the date or file number, and other settings as follows. These settings apply to all images in the print list.



- Press the  $\langle \text{MENU} \rangle$  button, and then choose [Print Settings] on the [D] tab. Choose and configure items as desired (📖 26).

Print Type	Standard	One image is printed per sheet.
	Index	Smaller versions of multiple images are printed per sheet.
	Both	Both standard and index formats are printed.
Date	On	Images are printed with the shooting date.
	Off	–
File No.	On	Images are printed with the file number.
	Off	–
Clear DPOF data	On	All image print list settings are cleared after printing.
	Off	–



- Not all of your DPOF settings may be applied in printing by the printer or photo development service, in some cases.
- [!] may be displayed on the camera to warn you that the memory card has print settings that were configured on another camera. Changing the print settings using this camera may overwrite all previous settings.
- Setting [Date] to [On] may cause some printers to print the date twice.





- Specifying [Index] will prevent you from choosing [On] for both [Date] and [File No.] at the same time.
- Index printing is not available on some Canon-brand PictBridge-compatible printers (sold separately).
- The date is printed in a format matching setting details in [Date/Time] on the [↑↑] tab (15).

#### Still Images



## Setting Up Printing for Individual Images

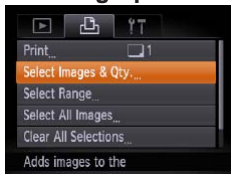

### 1 Choose [Select Images & Qty.].

- Press the <MENU> button, choose [Select Images & Qty.] on the [↑↑] tab, and then press the <FUNC SET> button.

### 2 Choose an image.

- Press the <◀>>>> buttons to choose an image, and then press the <FUNC SET> button.
- You can now specify the number of copies.
- If you specify index printing for the image, it is labeled with a [✓] icon. To cancel index printing for the image, press the <FUNC SET> button again. [✓] is no longer displayed.

## Setting Up Printing for a Range of Images



### 3 Specify the number of prints.

- Press the <▲><▼> buttons to specify the number of prints (up to 99).
- To set up printing for other images and specify the number of prints, repeat steps 2 – 3.
- Printing quantity cannot be specified for index prints. You can only choose which images to print, by following step 2.
- When finished, press the <MENU> button to return to the menu screen.

#### Still Images

- Following step 1 in “Setting Up Printing for Individual Images” (127), choose [Select Range] and press the <FUNC SET> button.
- Follow steps 2 – 3 in “Selecting a Range” (89) to specify images.
- Press the <▲><▼> buttons to choose [Order], and then press the <FUNC SET> button.

Before Use

Basic Guide

Advanced Guide

Camera Basics

Using GPS  
Functions

Auto Mode

Other Shooting  
Modes

P Mode

Playback Mode

Setting Menu

Accessories

Appendix

Index



## Setting Up Printing for All Images

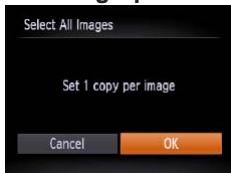

- Following step 1 in “Setting Up Printing for Individual Images” (127), choose [Select All Images] and press the button.
- Press the buttons to choose [OK], and then press the button.

## Clearing All Images from the Print List

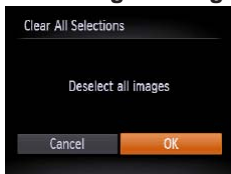

- Following step 1 in “Setting Up Printing for Individual Images” (127), choose [Clear All Selections] and press the button.
- Press the buttons to choose [OK], and then press the button.

## Printing Images Added to the Print List (DPOF)



- When images have been added to the print list (126 – 128), the screen at left is displayed after you connect the camera to a PictBridge-compatible printer. Press the buttons to choose [Print now], and then simply press the button to print the images in the print list.
- Any DPOF print job that you temporarily stop will be resumed from the next image.

## Adding Images to a Photobook

Photobooks can be set up on the camera by choosing up to 998 images on a memory card and importing them into the software on your computer, where they are stored in their own folder. This is convenient when ordering printed photobooks online or printing photobooks with your own printer.

## Choosing a Selection Method



- Press the button, choose [Photobook Set-up] on the tab, and then choose how you will select images.







- [!] may be displayed on the camera to warn you that the memory card has print settings that were configured on another camera. Changing the print settings using this camera may overwrite all previous settings.



- After importing images to your computer, also refer to "Software Instruction Manual" (119) and the printer manual for further information.

Still Images

## Adding Images Individually



### 1 Choose [Select].

- Following the procedure in "Choosing a Selection Method" (128), choose [Select] and press the <FUNC SET> button.



### 2 Choose an image.

- Press the <◀>>> buttons to choose an image, and then press the <FUNC SET> button.
- [✓] is displayed.
- To remove the image from the photobook, press the <FUNC SET> button again. [✓] is no longer displayed.
- Repeat this process to specify other images.
- When finished, press the <MENU> button to return to the menu screen.

## Adding All Images to a Photobook



- Following the procedure in "Choosing a Selection Method" (128), choose [Select All Images] and press the <FUNC SET> button.
- Press the <◀>>> buttons to choose [OK], and then press the <FUNC SET> button.

Still Images

## Removing All Images from a Photobook



- Following the procedure in "Choosing a Selection Method" (128), choose [Clear All Selections] and press the <FUNC SET> button.
- Press the <◀>>> buttons to choose [OK], and then press the <FUNC SET> button.

Still Images

Before Use

Basic Guide

Advanced Guide

Camera Basics

Using GPS Functions

Auto Mode

Other Shooting Modes

P Mode

Playback Mode

Setting Menu

Accessories

Appendix

Index



## Using an Eye-Fi Card

Before using an Eye-Fi card, always confirm that local use is permitted (📖2).

Inserting a prepared Eye-Fi card enables automatic wireless transfer of images to a computer or uploading to a photo-sharing website. Images are transferred by the Eye-Fi card. Refer to the card's user manual or contact the manufacturer for instructions on preparing and using cards or resolving transfer problems.



- When using an Eye-Fi card, keep the following points in mind.
  - Cards may continue to transmit radio waves even when [Eye-Fi trans.] is set to [Disable] (📖131). Remove the Eye-Fi card before entering hospitals, aircraft, or other areas where transmission is prohibited.
  - When troubleshooting image transfer issues, check the card and computer settings. For details, refer to the card's user manual.
  - Poor Eye-Fi connections may cause image transfer to take a long time, and transfer may be interrupted in some cases.
  - Eye-Fi cards may become hot, due to their transfer functions.
  - Battery power will be consumed faster than in normal use.
  - Camera operation may become sluggish. To resolve this, try setting [Eye-Fi trans.] to [Disable].

Connection status of Eye-Fi cards in the camera can be checked on the shooting screen (in regular information display mode) or playback screen (in simple information display mode).

(Gray)	Not connected	Interrupted
(Blinking white)	Connecting	Not communicating
(White)	Connected	Error acquiring Eye-Fi card information*2
(Animated)	Transfer in progress*1	

\*1 Power saving (📖23) on the camera is temporarily disabled during image transfer.

\*2 Restart the camera. Repeated display of this icon may indicate a problem with the card.

Images labeled with a icon have been transferred.



- Choosing [📷] mode will interrupt the Eye-Fi connection. Although the Eye-Fi connection will be restored after you choose another shooting mode or enter Playback mode, the camera may transfer any movies made in [📷] mode again.

## Checking Connection Information

Check the access point SSID used by the Eye-Fi card or the connection status, as needed.

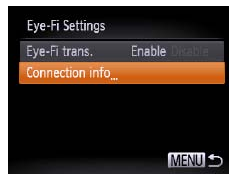

- Press the <MENU> button, choose [Eye-Fi Settings] on the [🔑] tab, and then press the <FUNC SET> button.
- Choose [Connection info], and then press the <FUNC SET> button.
- The connection information screen is displayed.

Before Use

Basic Guide

Advanced Guide

Camera Basics

Using GPS  
Functions

Auto Mode

Other Shooting  
Modes

P Mode

Playback Mode

Setting Menu

Accessories

Appendix

Index



## Disabling Eye-Fi Transfer

Configure the setting as follows to disable Eye-Fi transfer by the card, if necessary.

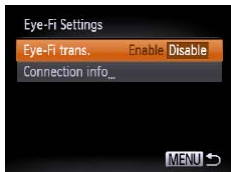

- Press the <MENU> button, choose [Eye-Fi Settings] on the [↑↑] tab, and then press the <Ⓜ> button.
- Choose [Eye-Fi trans.], and then choose [Disable].

- ! [Eye-Fi Settings] is not shown unless an Eye-Fi card is in the camera with its write-protect tab in the unlocked position. For this reason, you cannot change settings for an inserted Eye-Fi card if the write-protect tab is in the locked position.

Before Use

Basic Guide

Advanced Guide

Camera Basics

Using GPS  
Functions

Auto Mode

Other Shooting  
Modes

P Mode

Playback Mode

Setting Menu

Accessories

Appendix

Index



# Appendix

Helpful information when using the camera

<b>Troubleshooting</b> .....	<b>133</b>	<b>Functions and Menu Tables</b> .....	<b>140</b>	<b>Handling Precautions</b> .....	<b>146</b>
<b>On-Screen Messages</b> .....	<b>135</b>	Functions Available in Each Shooting Mode .....	140	<b>Specifications</b> .....	<b>147</b>
<b>On-Screen Information</b> .....	<b>137</b>	FUNC. Menu .....	141		
Shooting (Information Display) .....	137	📷 Shooting Tab Menu .....	143		
Playback (Detailed Information Display) .....	138	⏪ Set Up Tab Menu .....	145		
		▶ Playback Tab Menu .....	145		
		🖨️ Print Tab Menu .....	145		
		Playback Mode FUNC. Menu .....	146		

Before Use

Basic Guide

Advanced Guide

Camera Basics

Using GPS  
Functions

Auto Mode

Other Shooting  
Modes

P Mode

Playback Mode

Setting Menu

Accessories

Appendix

Index



## Troubleshooting

If you think there is a problem with the camera, first check the following. If the items below do not solve your problem, contact a Canon Customer Support Help Desk.

### Power

#### Nothing happens when the power button is pressed.

- Confirm that the battery pack is charged (📖13).
- Confirm that the battery pack is inserted facing the correct way (📖14).
- Confirm that the memory card/battery cover is fully closed (📖15).
- Dirty battery terminals reduce battery performance. Try cleaning the terminals with a cotton swab and reinserting the battery pack a few times.

#### The battery pack runs out of power quickly.

- Battery performance decreases at low temperatures. Try warming the battery pack a little by putting it in your pocket, for example, ensuring that the terminals do not touch any metal objects.
- If these measures do not help and the battery pack still runs out of power soon after charging, it has reached the end of its life. Purchase a new battery pack.
- Dirty battery terminals reduce battery performance. Try cleaning the terminals with a cotton swab and reinserting the battery pack a few times.

#### The battery pack is swollen.

- Battery swelling is normal and does not pose any safety concerns. However, if battery swelling prevents the battery pack from fitting in the camera, contact a Canon Customer Support Help Desk.

### Display on a TV

#### Camera images look distorted or not displayed on a TV (📖117).

### Shooting

#### Cannot shoot.

- In Playback mode (📖79), press the shutter button halfway (📖24).

#### Strange display on the screen under low light (📖24).

#### Strange display on the screen when shooting.

Note that the following display problems are not recorded in still images but are recorded in movies.

- The screen may flicker and horizontal banding may appear under fluorescent or LED lighting.

#### No date stamp is added to images.

- Configure the [Date Stamp] setting (📖15). Note that date stamps are not added to images automatically, merely because you have configured the [Date/Time] setting (📖42).
- Date stamps are not added in shooting modes (📖143) in which this setting cannot be configured (📖42).

#### [⚡] flashes on the screen when the shutter button is pressed, and shooting is not possible (📖37).

#### [📷] is displayed when the shutter button is pressed halfway (📖37).

- Set [IS Mode] to [Continuous] (📖78).
- Set the flash mode to [⚡] (📖77).
- Increase the ISO speed (📖69).
- Mount the camera on a tripod or take other measures to keep it still. In this case, you should set [IS Mode] to [Off] (📖78).

#### Shots are out of focus.

- Press the shutter button halfway to focus on subjects before pressing it all the way down to shoot (📖24).
- Make sure subjects are within focusing range (📖148).
- Set [AF-assist Beam] to [On] (📖47).
- Confirm that unneeded functions such as macro are deactivated.
- Try shooting with focus lock or AF lock (📖74, 76).

#### No AF frames are displayed and the camera does not focus when the shutter button is pressed halfway.

- To have AF frames displayed and the camera focus correctly, try composing the shot with higher-contrast subject areas centered before you press the shutter button halfway. Otherwise, try pressing the shutter button halfway repeatedly.

Before Use

Basic Guide

Advanced Guide

Camera Basics

Using GPS  
Functions

Auto Mode

Other Shooting  
Modes

P Mode

Playback Mode

Setting Menu

Accessories

Appendix

Index



### Subjects in shots look too dark.

- Set the flash mode to [⚡] (📖77).
- Adjust brightness by using exposure compensation (📖67).
- Adjust contrast by using i-Contrast (📖69, 100).
- Use AE lock or spot metering (📖68).

### Subjects look too bright, highlights are washed-out.

- Set the flash mode to [☀] (📖42).
- Adjust brightness by using exposure compensation (📖67).
- Use AE lock or spot metering (📖68).
- Reduce the lighting on subjects.

### Shots look too dark despite the flash firing (📖37).

- Shoot within flash range (📖148).
- Increase the ISO speed (📖69).

### Subjects in flash shots look too bright, highlights are washed-out.

- Shoot within flash range (📖148).
- Set the flash mode to [☀] (📖42).

### White dots or similar image artifacts appear in flash shots.

- This is caused by light from the flash reflecting off dust or airborne particles.

### Shots look grainy.

- Lower the ISO speed (📖69).
- High ISO speeds in some shooting modes may cause grainy images (📖52).

### Subjects are affected by red-eye (📖44).

- Set [Red-Eye Lamp] to [On] (📖48) to activate the red-eye reduction lamp (📖4) in flash shots. Note that while the red-eye reduction lamp is on (for about one second), it is not possible to shoot, because the lamp is counteracting red-eye. For best results, have subjects look at the red-eye reduction lamp. Also try increasing the lighting in indoor scenes and shooting at closer range.
- Edit images using red-eye correction (📖100).

### Recording to the memory card takes too long, or continuous shooting is slower.

- Use the camera to perform low-level formatting of the memory card (📖107).

### Shooting settings or FUNC. menu settings are not available.

- Available setting items vary by shooting mode. Refer to “Functions Available in Each Shooting Mode”, “FUNC. Menu”, and “Shooting Tab Menu” (📖140 – 144).

## Shooting Movies

### The elapsed time shown is incorrect, or recording is interrupted.

- Use the camera to format the memory card, or switch to a card that supports high-speed recording. Note that even if the elapsed time display is incorrect, the length of movies on the memory card corresponds to the actual recording time (📖106, 148).

### [🔴] is displayed and shooting stops automatically.

The camera’s internal memory buffer filled up as the camera could not record to the memory card quickly enough. Try one of the following measures.

- Use the camera to perform low-level formatting of the memory card (📖107).
- Lower the image quality (📖45).
- Switch to a memory card that supports high-speed recording (📖148).

### Zooming is not possible.

- Zooming is not possible when shooting movies in [📷] (📖55) and [📷] (📖64) modes.

### Subjects look distorted.

- Subjects that pass in front of the camera quickly may look distorted. This is not a malfunction.

## Playback

### Playback is not possible.

- Image or movie playback may not be possible if a computer is used to rename files or alter the folder structure. Refer to “Software Instruction Manual” (📖119) for details on folder structure and file names.

### Playback stops, or audio skips.

- Switch to a memory card that you have performed low-level formatting on with the camera (📖107).
- There may be brief interruptions when playing movies copied to memory cards that have slow read speeds.
- When movies are played on a computer, frames may be dropped and audio may skip if computer performance is inadequate.

Before Use

Basic Guide

Advanced Guide

Camera Basics

Using GPS  
Functions

Auto Mode

Other Shooting  
Modes

P Mode

Playback Mode

Setting Menu

Accessories

Appendix

Index



## Sound is not played during movies.

- Adjust the volume (📖80) if you have activated [Mute] (📖104) or the sound in the movie is faint.
- No sound is played for movies shot in [📹] (📖55) or [📹] (📖64) mode because audio is not recorded in these modes.

## Memory Card

### The memory card is not recognized.

- Restart the camera, with the memory card in it (📖23).

## Computer

### Cannot transfer images to a computer.

When attempting to transfer images to the computer via a cable, try reducing the transfer speed as follows.

- Press the <▶> button to enter Playback mode. Hold the <MENU> button down as you press the <▲> and <📷> buttons at the same time. On the next screen, press the <◀><▶> buttons to choose [B], and then press the <📷> button.

## Eye-Fi Cards

### Cannot transfer images (📖130).

## On-Screen Messages

If an error message is displayed, respond as follows.

### No memory card

- The memory card may be inserted facing the wrong way. Reinsert the memory card facing the correct way (📖14).

### Memory card locked

- The write-protect tab of the memory card is set to the locked position. Switch the write-protect tab to the unlocked position (📖14).

### Cannot record!

- Shooting was attempted without a memory card in the camera. To shoot, insert a memory card facing the correct way (📖14).

### Memory card error (📖107)

- If the same error message is displayed even after you have formatted a supported memory card (📖2) and have inserted it facing the correct way (📖14), contact a Canon Customer Support Help Desk.

### Insufficient space on card

- There is not enough free space on the memory card to shoot (📖35, 50, 66) or edit images (📖97 – 101). Either erase unneeded images (📖90) or insert a memory card with enough free space (📖14).

### Change the battery pack. (📖14)

### No Image.

- The memory card does not contain any images that can be displayed.

### Protected! (📖87)

### Unidentified Image/Incompatible JPEG/Image too large./Cannot play back AVI/RAW

- Unsupported or corrupt images cannot be displayed.
- It may not be possible to display images that were edited or renamed on a computer, or images shot with another camera.

Before Use

Basic Guide

Advanced Guide

Camera Basics

Using GPS  
Functions

Auto Mode

Other Shooting  
Modes

P Mode

Playback Mode

Setting Menu

Accessories

Appendix

Index



### Cannot magnify!/Cannot play back this content in Smart Shuffle/ Cannot rotate/Cannot modify image/Cannot register this image!/ Cannot modify/Cannot assign to category/Unselectable image.

- The following functions may be unavailable for images that were renamed or already edited on a computer, or images shot with another camera. Note that starred (\*) functions are not available for movies.  
Magnify\* (📖85), Smart Shuffle\* (📖87), Rotate\* (📖93), Favorites (📖94), Edit\* (📖97 – 101), Print List\* (📖126), and Photobook Set-up\* (📖128).

### Invalid selection range

- When specifying a range for image selection (📖89, 92, 127), you attempted to choose an initial image that was after the final image, or vice-versa.

### Exceeded selection limit

- More than 998 images were selected for Print List (📖126) or Photobook Set-up (📖128). Choose 998 images or less.
- Print List (📖126) or Photobook Set-up (📖128) settings could not be saved correctly. Reduce the number of selected images and try again.
- You attempted to choose more than 500 images in Protect (📖87), Erase (📖90), Favorites (📖94), My Category (📖95), Print List (📖126), or Photobook Set-up (📖128).

### Communication error

- An excessive amount of images (approx. 1,000) on the memory card prevented printing or image transfer to a computer. To transfer the images, use a commercially available USB card reader. To print, insert the memory card directly into the printer card slot.

### Naming error!

- The folder could not be created or images could not be recorded, because the highest supported folder number (999) for storing images on the card has been reached and the highest supported image number (9999) for images in folders has been reached. On the [📁] tab, change [File Numbering] to [Auto Reset] (📖108), or format the memory card (📖106).

### Lens Error

- A lens error was detected. Press the power button to turn the camera off and on again (📖23).
- Frequent display of this error message may indicate camera damage. In this case, contact a Canon Customer Support Help Desk.

### A camera error was detected (error number)

- If this error message is displayed immediately after a shot, the image may not have been saved. Switch to Playback mode to check for the image.
- Frequent display of this error message may indicate camera damage. In this case, write down the error number (Exx) and contact a Canon Customer Support Help Desk.

### File Error

- Correct printing (📖122) may not be possible for photos from other cameras or images that have been altered using computer software, even if the camera is connected to the printer.

### Print error

- Check the paper size setting (📖124). If this error message is displayed when the setting is correct, restart the printer and complete the setting on the camera again.

### Ink absorber full

- Contact a Canon Customer Support Help Desk to request assistance with ink absorber replacement.

Before Use

Basic Guide

Advanced Guide

Camera Basics

Using GPS  
Functions

Auto Mode

Other Shooting  
Modes

P Mode

Playback Mode

Setting Menu

Accessories

Appendix

Index





# On-Screen Information

## Shooting (Information Display)

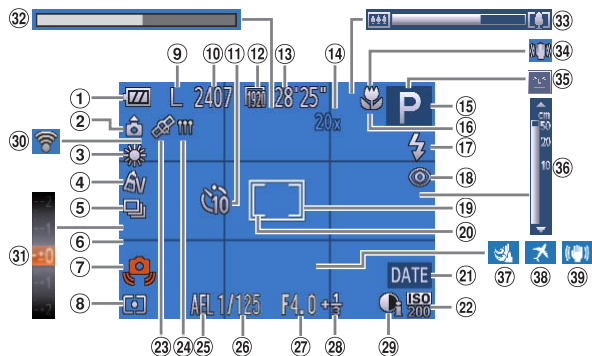

- ① Battery level (138)
- ② Camera orientation\*
- ③ White balance (69)
- ④ My Colors (70)
- ⑤ Drive mode (71)
- ⑥ Grid lines (46)
- ⑦ Camera shake warning (37)
- ⑧ Metering method (68)
- ⑨ Resolution (44)
- ⑩ Recordable shots (148)
- ⑪ Self-timer (40)
- ⑫ Movie quality (45)
- ⑬ Remaining time (148)
- ⑭ Digital zoom magnification (40), Digital tele-converter (73)
- ⑮ Shooting mode (140), Scene icon (38)
- ⑯ Focusing range (72), AF lock (76)
- ⑰ Flash mode (42, 77)

- ⑱ Red-eye correction (44)
- ⑲ AF frame (74)
- ⑳ Spot AE point frame (68)
- ㉑ Date stamp (42)
- ㉒ ISO speed (69)
- ㉓ GPS reception status (30)
- ㉔ GPS logging indicator (31)
- ㉕ AE lock (68), FE lock (77)
- ㉖ Shutter speed
- ㉗ Aperture value
- ㉘ Exposure compensation level (67)
- ㉙ i-Contrast (69)
- ㉚ Eye-Fi connection status (130)
- ㉛ Exposure compensation bar (67)
- ㉜ Super slow motion movie (shooting time) (64)
- ㉝ Zoom bar (35)
- ㉞ IS mode icon (39)
- ㉟ Blink detection (47)
- ㊱ MF indicator (72)
- ㊲ Wind filter (45)
- ㊳ Time zone (109)
- ㊴ Image stabilization (78)

\* : Regular orientation, : Held vertically

The camera detects the shooting orientation and adjusts settings for optimal shots. Orientation is also detected during playback, and in either orientation, the camera automatically rotates images as needed. However, the orientation may not be detected correctly when the camera is pointed straight up or down.

Before Use

Basic Guide

Advanced Guide

Camera Basics

Using GPS Functions

Auto Mode

Other Shooting Modes

P Mode

Playback Mode

Setting Menu

Accessories

Appendix

Index



## Battery Level

An on-screen icon or message indicates the battery charge level.

Display	Details
	Sufficient charge
	Slightly depleted, but sufficient
	Nearly depleted—charge the battery pack soon
[Change the battery pack.]	Depleted—charge the battery pack immediately

## Playback (Detailed Information Display)

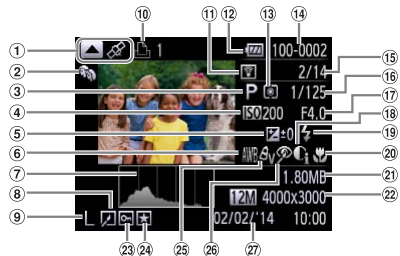

- ① Movies (📖35, 80), Switch display (GPS information) (📖82)
- ② My Category (📖95)
- ③ Shooting mode (📖140)
- ④ ISO speed (📖69), Playback speed (📖55)
- ⑤ Exposure compensation level (📖67)
- ⑥ White balance (📖69)
- ⑦ Histogram (📖82)
- ⑧ Image editing (📖97 – 101)
- ⑨ Resolution (📖44, 45, 64), MOV (movies)
- ⑩ Print list (📖122)
- ⑪ Transferred via Eye-Fi (📖130)
- ⑫ Battery level (📖138)
- ⑬ Metering method (📖68)
- ⑭ Folder number - File number (📖108)
- ⑮ Current image no. / Total no. of images
- ⑯ Shutter speed (still images), Image quality / Frame rate (movies) (📖44, 45, 64)
- ⑰ Aperture value
- ⑱ i-Contrast (📖69, 100)
- ⑲ Flash (📖77)
- ⑳ Focusing range (📖72)
- ㉑ File size
- ㉒ Still images: Resolution (📖148) Movies: Playback time (📖148)
- ㉓ Protection (📖87)
- ㉔ Favorites (📖94)
- ㉕ My Colors (📖70, 99), White balance correction (📖53)
- ㉖ Red-eye correction (📖44, 100)
- ㉗ Shooting date/time (📖15)

Before Use

Basic Guide

Advanced Guide

Camera Basics

Using GPS Functions

Auto Mode

Other Shooting Modes

P Mode

Playback Mode

Setting Menu

Accessories

Appendix









Index





- Some information may not be displayed when viewing images on a TV (📖115).

## Summary of Movie Control Panel in "Viewing" (📖80)

	Exit
	Play
	Slow Motion (Press the <◀><▶> buttons to adjust the playback speed. No sound is played.)
	Skip Backward* (To continue skipping backward, keep holding down the <⏮> button.)
	Previous Frame (For fast-rewind, keep holding down the <⏪> button.)
	Next Frame (For fast-forward, keep holding down the <⏩> button.)
	Skip Forward* (To continue skipping forward, keep holding down the <⏭> button.)
	Edit (📖101)
	Shown when the camera is connected to a PictBridge-compatible printer (📖122).

\* Displays the frame approx. 4 sec. before or after the current frame.



- To skip forward or back during movie playback, press the <◀><▶> buttons or gently tap the sides of the camera (Active Display) (📖81).

Before Use

Basic Guide

Advanced Guide

Camera Basics

Using GPS  
Functions

Auto Mode

Other Shooting  
Modes

P Mode

Playback Mode

Setting Menu

Accessories

Appendix

Index



# Functions and Menu Tables

## Functions Available in Each Shooting Mode

Function	Shooting Mode		Camera Modes																			
	AUTO		P																			
Flash ( <a href="#">42</a> , <a href="#">77</a> )																						
	O	O	O	O	O	O	O	O	O	O	O	O	O	O	O	O	O	O	O	O	O	O
	-	O	O	O	O	O	O	O	O	O	O	O	O	O	O	O	O	O	O	O	O	O
	*1	O	-	-	-	O	-	-	-	-	-	-	-	-	-	-	-	-	-	*2	O	-
	O	O	O	O	O	O	O	O	O	O	O	O	O	O	O	O	O	O	O	O	O	O
AE Lock/FE Lock ( <a href="#">68</a> , <a href="#">77</a> )*3	-	O	-	-	-	O	-	-	-	-	-	-	-	-	-	-	-	-	-	-	-	
AF Lock ( <a href="#">68</a> )	-	O	-	-	-	O	-	-	-	-	-	-	-	-	-	-	-	-	-	O	-	
Focusing Range ( <a href="#">72</a> , <a href="#">76</a> )																						
	-	O	-	O	O	O	O	-	-	-	O	O	O	O	O	O	O	O	O	O	O	
	O	O	O	-	O	O	O	O	O	O	O	O	O	O	O	O	O	O	O	O	O	
	-	-	O	-	-	-	-	-	-	-	-	-	-	-	-	-	-	-	-	-	-	
MF	-	O	O	O	O	O	O	-	-	-	O	O	O	O	O	O	O	O	O	O	-	
Tracking AF ( <a href="#">75</a> )	-	O	O	O	O	-	O	-	-	-	-	O	O	O	O	O	O	O	O	O	-	
Screen Display ( <a href="#">24</a> )																						
No Information Display	O	O	O	O	O	O	O	-	-	-	O	O	-	-	-	O	O	-	O	O	-	
Information Display	O	O	O	O	O	O	O	O	O	O	O	O	O	O	O	O	O	O	O	O	O	O

\*1 Not available, but switches to in some cases.

\*2 Not available, but switches to when the flash fires.

\*3 FE lock not available in flash mode.

O Available or set automatically. - Not available.

Before Use

Basic Guide

Advanced Guide

Camera Basics

Using GPS Functions

Auto Mode

Other Shooting Modes

P Mode

Playback Mode

Setting Menu

Accessories

Appendix

Index



# FUNC. Menu

Function	Shooting Mode																				
	AUTO	P																			
<b>GPS Settings (M30)</b>																					
Off/On	O	O	O	O	O	O	O	O	O	O	O	O	O	O	O	O	O	O	O	O	
<b>Metering Method (M68)</b>																					
	O	O	O	O	O	O	O	O	O	O	O	O	O	O	O	O	O	O	O	O	
	-	O	-	-	-	O	-	-	-	-	-	-	-	-	-	-	-	-	-	-	
<b>My Colors (M70)</b>																					
Off	O	O	O	O	O	O	O	O	O	O	O	O	O	O	O	O	O	O	O	O	
	-	O	-	-	-	O	-	O	O	O	-	-	-	-	-	-	-	-	O	O	-
<b>White Balance (M69)</b>																					
AWB	O	O	O	O	O	O	O	O	O	O	O	O	O	O	O	O	O	O	O	O	
	-	O	-	-	-	O	-	O	O	-	O	-	-	-	-	-	-	-	O	O	-
	-	O	O	O	-	O	-	O	O	-	O	-	-	-	-	-	-	-	O	O	-
<b>Underwater White Balance Correction (M53)</b>																					
	-	-	O	O	-	-	-	-	-	-	-	-	-	-	-	-	-	-	-	-	-
<b>ISO Speed (M69)</b>																					
Auto	O	O	O	O	O	O	O	O	O	O	O	O	O	O	O	O	O	O	O	O	
100 150 200 400 800 1600 3200	-	O	-	-	-	O	-	-	-	-	-	-	-	-	-	-	-	-	-	-	-
<b>Exposure Compensation (M67)</b>																					
	-	O	O	O	O	O	O	O	O	O	O	O	O	O	O	O	O	O	O	O	-
<b>Self-Timer (M40)</b>																					
	O	O	O	O	O	O	O	O	O	O	O	O	O	O	O	O	O	O	O	O	O
	O	O	O	O	O	O	-	-	-	O	O	O	O	O	O	O	O	O	O	O	O
<b>Self-Timer Settings (M41)</b>																					
Delay*4	O	O	O	O	O	O	O	-	-	-	O	O	O	O	O	O	O	O	O	O	O
Shots*5	O	O	O	O	O	-	O	-	-	-	O	O	O	O	O	O	O	O	O	O	-

\*1 White balance is not available.

\*2 Set in a range of 1 – 5: contrast, sharpness, color saturation, red, green, blue, and skin tone.

\*3 Not available in [C] or [L].

\*4 Cannot be set to 0 seconds in modes without selection of the number of shots.

\*5 One shot (cannot be modified) in modes without selection of the number of shots.

O Available or set automatically. – Not available.

Before Use

Basic Guide

Advanced Guide

Camera Basics

Using GPS Functions

Auto Mode

Other Shooting Modes

P Mode

Playback Mode

Setting Menu

Accessories

Appendix

Index





# Shooting Tab Menu

Function	Shooting Mode		AUTO																			
	AUTO		P	Sh	Av	Mv	TV	Bv	CC	CC	CC	CC	CC	CC	CC	CC	CC	CC	CC	CC	CC	CC
<b>AF Frame (74)</b>																						
Face AiAF*1	O	O	-	-	O	O	O	O	O	O	O	O	O	O	O	O	O	O	O	O	O	O
Tracking AF	-	O	O	O	O	-	O	-	-	-	-	O	-	-	-	O	O	O	O	-	O	-
Center	-	O	O	O	O	O	O	-	-	-	-	O	O	-	O	O	O	O	O	O	O	O
<b>AF Frame Size (74)*2</b>																						
Normal	-	O	O	O	O	O	O	-	-	-	-	O	O	-	O	O	O	O	O	O	O	O
Small	-	O	O	O	O	O	O	-	-	-	-	O	-	-	O	O	O	O	O	O	-	O
<b>Digital Zoom (40)</b>																						
Standard	O	O	O	O	O	O	O	O	O	O	-	-	-	-	-	-	-	-	-	O	O	-
Off	O	O	O	-	O	O	O	O	O	O	O	O	O	O	O	O	O	O	O	O	O	O
1.5x/2.0x	-	O	-	-	-	-	-	-	-	-	-	-	-	-	-	-	-	-	-	-	-	-
<b>AF-Point Zoom (46)</b>																						
On	O	O	O	O	O	-	O	O	O	O	-	O	-	-	-	O	O	O	O	-	O	-
Off	O	O	O	O	O	O	O	O	O	O	O	O	O	O	O	O	O	O	O	O	O	O
<b>Servo AF (76)</b>																						
On	-	O	O	O	O	-	O	-	-	-	-	O	-	-	-	O	O	O	O	-	-	-
Off*3	O	O	O	O	O	O	O	O	O	O	O	O	O	O	O	O	O	O	O	O	O	O
<b>AF-assist Beam (47)</b>																						
On	O	O	-	-	O	O	O	O	O	O	O	O	O	O	O	O	O	O	O	O	-	O
Off	O	O	O	O	O	O	O	-	O	O	O	O	O	O	O	O	O	O	O	O	O	O
<b>MF-Point Zoom (72)</b>																						
On	-	O	O	O	O	-	O	-	-	-	-	O	-	-	-	O	O	O	O	-	O	-
Off	O	O	O	O	O	O	O	O	O	O	O	O	O	O	O	O	O	O	O	O	O	O
<b>Safety MF (72)</b>																						
On	-	O	O	O	O	O	O	-	-	-	O	O	O	O	O	O	O	O	O	O	-	O
Off	O	O	O	O	O	O	O	O	O	O	O	O	O	O	O	O	O	O	O	O	O	O

\*1 Operation when no faces are detected varies by shooting mode.

\*2 Available when the AF frame is set to [Center].

\*3 [On] when subject movement is detected in [AUTO] mode.

O Available or set automatically. - Not available.

Before Use

Basic Guide

Advanced Guide

Camera Basics

Using GPS Functions

Auto Mode

Other Shooting Modes

P Mode

Playback Mode

























Setting Menu

Accessories

Appendix

Index



Shooting Mode		AUTO																								
		                        																								
Function																										
Flash Settings (📖44, 48)																										
Red-Eye Corr.	On	○	○	-	-	○	○	○	○	○	○	○	○	-	○	-	-	-	-	-	-	○	-	-	-	
	Off	○	○	○	○	○	○	○	○	○	○	○	○	-	○	○	○	○	○	○	○	○	-	○	○	-
Red-Eye Lamp	On	○	○	-	-	○	○	○	○	○	○	○	○	-	○	○	○	○	○	○	○	○	-	○	○	-
	Off	○	○	○	○	○	○	○	○	○	○	○	○	-	○	○	○	○	○	○	○	○	-	○	○	-
i-Contrast (📖69)																										
Auto	On	○	○	○	○	-	○	-	-	-	-	-	○	-	-	-	-	-	-	-	-	-	-	-	-	
	Off	-	○	-	-	○	○	○	○	○	○	○	○	-	○	○	○	○	○	○	○	○	○	○	○	○
Wind Filter (📖45)																										
On/Off		○	○	○	○	○	○	○	○	○	○	○	○	○	○	○	○	○	○	○	○	○	○	○	○	-
Review (📖48)																										
Off/2 – 10 sec./Hold		○	○	○	○	○	○	○	○	○	○	○	○	○	○	○	○	○	○	○	○	○	○	○	○	-
Review Info (📖49)																										
Off	On	○	○	○	○	○	○	○	○	○	○	○	○	○	○	○	○	○	○	○	○	○	○	○	○	-
	Detailed/Focus Check	○	○	○	○	○	○	○	○	○	○	○	○	○	○	○	○	○	○	○	○	○	○	○	○	-
Blink Detection (📖47)																										
On	On	○	○	-	-	○	○	○	○	○	○	○	-	○	-	-	-	-	○	○	○	-	-	-	-	-
	Off	○	○	○	○	○	○	○	○	○	○	○	○	○	○	○	○	○	○	○	○	○	○	○	○	○
Grid Lines (📖46)																										
On	On	○	○	○	○	○	○	○	○	○	○	○	○	○	○	○	○	○	○	○	○	○	○	○	○	-
	Off	○	○	○	○	○	○	○	○	○	○	○	○	○	○	○	○	○	○	○	○	○	○	○	○	○
IS Settings (📖78)																										
IS Mode	Off	○	○	○	○	○	○	○	○	○	○	○	-	○	○	○	○	○	○	○	○	○	○	○	○	○
	Continuous	○	○	○	○	○	○	○	○	○	○	○	○	○	○	○	○	○	○	○	○	○	○	○	○	○
	Shoot Only	-	○	○	○	○	-	○	○	○	○	-	○	○	○	○	○	○	○	○	○	○	○	○	○	-
Powered IS	On	○	○	○	○	○	○	○	○	○	○	○	○	○	○	○	○	○	○	○	○	○	○	○	○	○
	Off	○	○	○	○	○	○	○	○	○	○	○	-	○	○	○	○	○	○	○	○	○	○	○	○	○
Date Stamp (📖42)																										
Off	On	○	○	○	○	○	○	○	○	○	○	○	○	○	○	○	○	○	○	○	○	○	○	○	○	○
	Date/Date & Time	○	○	○	○	○	○	○	○	○	○	○	-	-	-	-	-	-	-	-	-	○	○	-	-	-

○ Available or set automatically. - Not available.

- Before Use
- Basic Guide
- Advanced Guide
- Camera Basics
- Using GPS Functions
- Auto Mode
- Other Shooting Modes
- P Mode
- Playback Mode
- Setting Menu
- Accessories
- Appendix
- Index





## ☰ Set Up Tab Menu

Item	Ref. Page	Item	Ref. Page
Mute	104	Time Zone	109
Volume	104	Date/Time	15
Sound Options	104	GPS Auto Time	33
Hints & Tips	105	GPS Settings	30, 109
LCD Brightness	105	Units	110
Sunlight LCD	105	Video System	117
Start-up Image	106	Ctrl via HDMI	116
Format	106, 107	Eye-Fi Settings	130
File Numbering	108	Language 	17
Create Folder	108	Reset All	110
Power Saving	23, 108		

## ▶ Playback Tab Menu

Item	Ref. Page	Item	Ref. Page
Slideshow	86	Trimming	98
Erase	90	Resize	97
Protect	87	My Colors	99
Rotate	93	Active Display	81
Favorites	94	Scroll Display	81
My Category	95	Auto Rotate	94
Photobook Set-up	128	Resume	81
i-Contrast	100	Transition	81
Red-Eye Correction	100		

## 🖨️ Print Tab Menu

Item	Ref. Page	Item	Ref. Page
Print	-	Select All Images	128
Select Images & Qty.	127	Clear All Selections	128
Select Range	127	Print Settings	126

Before Use

Basic Guide

Advanced Guide

Camera Basics

Using GPS  
Functions

Auto Mode

Other Shooting  
Modes

P Mode

Playback Mode

Setting Menu

Accessories

Appendix

Index



## Playback Mode FUNC. Menu

Item	Ref. Page	Item	Ref. Page
Rotate	93	Play Movie	80
Print List	126	Movie Digest Playback	85
Print	122	Smart Shuffle	87
Protect	87	Image Search	84
Favorites	94	Slideshow	86
Erase	90		

## Handling Precautions

- The camera is a high-precision electronic device. Avoid dropping it or subjecting it to strong impact.
- Never bring the camera near magnets, motors, or other devices that generate strong electromagnetic fields, which may cause malfunction or erase image data.
- If water droplets or dirt adheres to the camera or screen, wipe with a dry soft cloth, such as an eyeglass cloth. Do not rub hard or apply force.
- Never use cleaners containing organic solvents to clean the camera or screen.
- Use a blower brush to remove dust from the lens. If cleaning is difficult, contact a Canon Customer Support Help Desk.
- To prevent condensation from forming on the camera after sudden temperature changes (when the camera is transferred from cold to warm environments), put the camera in an airtight, resealable plastic bag and let it gradually adjust to the temperature before removing it from the bag.
- If condensation does form on the camera, stop using it immediately. Continuing to use the camera in this state may damage it. Remove the battery pack and memory card, and wait until the moisture has evaporated before resuming use.
- Before long-term battery storage, use up the battery pack's remaining charge, remove it from the camera, and store it in a plastic bag or similar container. Storing a partially charged battery pack over extended periods (about a year) may shorten its life or affect performance.

Before Use

Basic Guide

Advanced Guide

Camera Basics

Using GPS  
Functions

Auto Mode

Other Shooting  
Modes

P Mode

Playback Mode

Setting Menu

Accessories

Appendix

Index



## Specifications

<b>Camera Effective Pixels (Max.)</b>	Approx. 12.1 million pixels
<b>Lens Focal Length</b>	5x zoom: 5.0 (W) – 25.0 (T) mm (35mm film equivalent: 28 (W) – 140 (T) mm)
<b>Waterproof Capability</b>	IEC/JIS protection class "IPX8" equivalent*1 For use within a depth of 25 meters (82 ft.) up to 60 minutes.
<b>Dustproof Capability</b>	IEC/JIS protection class "IP6X" equivalent*1
<b>Shock Resistant Capability</b>	Canon standard based on MIL Standard 810F Method 516.5 Selecting Procedure IV (A US Defense Standard) *1*2 cleared
<b>LCD Monitor</b>	3.0-type color TFT LCD Effective Pixels: Approx. 461,000 dots
<b>File Format</b>	Design rule for Camera File system, DPOF (version 1.1) compliant
<b>Data Type</b>	Still Images: Exif 2.3 (JPEG) Movies: MOV (Video: MPEG-4 AVC/H.264; Audio: Linear PCM (monaural)) GPS log files: NMEA 0183 message format compliant
<b>Interface</b>	Hi-speed USB HDMI output Analog audio output (monaural) Analog video output (NTSC/PAL)
<b>Power Source</b>	Battery Pack NB-6LH AC Adapter Kit ACK-DC40
<b>Operating Temperature*3</b>	-10 – 40 °C (14 – 104 °F)
<b>Dimensions (Based on CIPA Guidelines)</b>	109.4 x 68.0 x 27.5 mm (4.31 x 2.68 x 1.08 in.)
<b>Weight (Based on CIPA Guidelines)</b>	Approx. 218 g (approx. 7.69 oz.; including the battery pack and memory card) Approx. 194 g (approx. 6.84 oz.; camera body only)

\*1 The camera is subjected to Canon standard testing conditions. However, it is not guaranteed that this camera will not be damaged or malfunction.

\*2 Testing conditions:

Drop height: 2.0 m (6.5 ft.)

Drop surface: Plywood

Drop direction: Each surface (6 surfaces), each angle (4 angles) for a total of 10

Number of drops: Each surface and each angle 3 times for a total of 30

\*3 Temperatures in the range -10 to 0 °C (14 to 32 °F) are below the recommended operating temperature range for Battery Pack NB-6LH. Although this may affect battery performance temporarily, operation is still possible.

### Digital Zoom Focal Length (35mm equivalent)

<b>Digital Zoom [Standard]</b>	28 – 560 mm (Represents the combined focal length of optical and digital zoom.)
<b>Digital Tele-Converter 1.5x</b>	42.0 – 210.0 mm
<b>Digital Tele-Converter 2.0x</b>	56.0 – 280.0 mm

### Number of Shots/Recording Time, Playback Time

<b>Number of Shots</b>	Approx. 300
<b>Movie Recording Time*1</b>	Approx. 1 hour
<b>Continuous Shooting*2</b>	Approx. 1 hour, 40 minutes
<b>Playback Time</b>	Approx. 6 hours

\*1 Time under default camera settings, when normal operations are performed, such as shooting, pausing, turning the camera on and off, and zooming.

\*2 Time available when shooting the maximum movie length (until recording stops automatically) repeatedly.

- The number of shots that can be taken is based on measurement guidelines of the Camera & Imaging Products Association (CIPA).
- Under some shooting conditions, the number of shots and recording time may be less than mentioned above.
- Number of shots/time with a fully charged battery pack.

Before Use

Basic Guide

Advanced Guide

Camera Basics

Using GPS Functions

Auto Mode

Other Shooting Modes

P Mode

Playback Mode

Setting Menu

Accessories

Appendix

Index







## Number of 4:3 Shots per Memory Card

Recording Pixels	Number of Shots per Memory Card (Approx. shots)	
	8 GB	32 GB
<b>L</b> (Large) 12M/4000x3000	2505	10115
<b>M1</b> (Medium 1) 2M/2816x2112	4723	19064
<b>M2</b> (Medium 2) 2M/1600x1200	12927	52176
<b>S</b> (Small) 0.3M/640x480	40937	165225

- The values in the table are based on Canon measurement conditions and may change depending on the subject, memory card and camera settings.
- The values in the table are based on 4:3 aspect ratio. The number of shots available varies by aspect ratio (📖43).

## Recording Time per Memory Card

Image Quality	Recording Time per Memory Card	
	8 GB	32 GB
	29 min. 39 sec.	1 hr. 59 min. 43 sec.
	42 min. 11 sec.*1	2 hr. 50 min. 19 sec.*2
	1 hr. 28 min. 59 sec.	5 hr. 59 min. 10 sec.
	26 min. 24 sec.	1 hr. 46 min. 35 sec.
	52 min. 28 sec.	3 hr. 31 min. 49 sec.

\*1 27 min. 39 sec. for iFrame movies (📖64).

\*2 1 hr. 51 min. 37 sec. for iFrame movies (📖64).



- The values in the table are based on Canon measurement conditions and may change depending on the subject, memory card and camera settings.
- Recording will automatically stop when the clip file size reaches 4 GB, or when the recording time reaches approximately 29 minutes and 59 seconds when shooting in [1920] or [1280], or approximately 1 hour when shooting in [640].

- Recording may stop even if the maximum clip length has not been reached on some memory cards. SD Speed Class 6 or higher memory cards are recommended.

## Flash Range

Maximum wide angle (📷)	30 cm – 3.5 m (12 in. – 11 ft.)
Maximum telephoto (📷)	1.0 – 3.0 m (3.3 – 9.8 ft.)

## Shooting Range

Shooting Mode	Focusing Range	Maximum Wide Angle (📷)	Maximum Telephoto (📷)
<b>AUTO</b>	–	1 cm (0.4 in.) – infinity	1 m (3.3 ft.) – infinity
Other modes	 MF	1 – 50 cm (0.4 in. – 1.6 ft.)	–
	 MF*	1 – 50 cm (0.4 in. – 1.6 ft.)	–
	 A	5 cm (2.0 in.) – infinity	1 m (3.3 ft.) – infinity
	<b>MF*</b>	1 cm (0.4 in.) – infinity	1 m (3.3 ft.) – infinity

\* Not available in some shooting modes.

- Approximately 1.3x for underwater shots.

Before Use

Basic Guide

Advanced Guide

Camera Basics

Using GPS Functions

Auto Mode

Other Shooting Modes

P Mode

Playback Mode

Setting Menu

Accessories

Appendix

Index



## Continuous Shooting Speed

Approx. 1.9 shots/sec.

## Shutter Speed

[AUTO] mode, automatically set range	1 – 1/1600 sec.
--------------------------------------	-----------------

## Aperture

f/number	f/3.9 / f/8.0 (W), f/4.8 / f/10 (T)
----------	-------------------------------------

## Battery Pack NB-6LH

Type:	Rechargeable lithium-ion battery
Nominal Voltage:	3.7 V DC
Nominal Capacity:	1060 mAh
Charging Cycles:	Approx. 300 times
Operating Temperatures:	0 – 40 °C (32 – 104 °F)
Dimensions:	34.4 x 41.8 x 6.9 mm (1.35 x 1.65 x 0.27 in.)
Weight:	Approx. 22 g (approx. 0.78 oz.)

## Battery Charger CB-2LY/CB-2LYE

Rated Input:	100 – 240 V AC (50/60 Hz), 0.085 A (100 V) – 0.05 A (240 V)
Rated Output:	4.2 V DC, 0.7 A
Charging Time:	Approx. 2 hr. (when using NB-6LH)
Charge Indicator:	Charging: orange / Fully charged: green (two-indicator system)
Operating Temperatures:	0 – 40 °C (32 – 104 °F)

Before Use

Basic Guide

Advanced Guide

Camera Basics

Using GPS  
Functions

Auto Mode

Other Shooting  
Modes

P Mode

Playback Mode

Setting Menu

Accessories

Appendix

Index



<b>A</b>	
AC adapter kit.....	114, 118
Accessories.....	114
Active Display.....	81
AE lock.....	68
AF frames.....	74
AF lock.....	76
Aspect ratio.....	43
AUTO mode (shooting mode).....	18, 35
AV cable.....	115, 117
<b>B</b>	
Batteries → Date/time (date/time battery)	
Power saving.....	23
Battery charger.....	2, 114
Battery pack	
Charging.....	13
Level.....	138
Power saving.....	23
Black and white images.....	70
Blink detection.....	47
<b>C</b>	
Camera	
Reset all.....	110
CameraWindow (computer).....	119
Center (AF frame mode).....	74
Clock.....	27
Color Accent (shooting mode).....	57
Color Swap (shooting mode).....	58
Color (white balance).....	69
Continuous shooting.....	71
Cropping.....	98, 124
Custom white balance.....	70
<b>D</b>	
Date/time	
Adding date stamps.....	42
Changing.....	16
Date/time battery.....	17
Settings.....	15
World clock.....	109
Defaults → Reset all	
Digital tele-converter.....	73
Digital zoom.....	40
Display language.....	17
DPOF.....	126
Drive mode.....	71
<b>E</b>	
Editing	
Cropping.....	98
i-Contrast.....	100
My Colors.....	99
Red-eye correction.....	100
Resizing images.....	97
Erasing.....	90
Error messages.....	135
Exposure	
AE lock.....	68
Compensation.....	67
FE lock.....	77

Eye-Fi cards.....	2, 130
-------------------	--------

## F

Face AiAF (AF frame mode).....	74
Face self-timer (shooting mode).....	61
Favorites.....	94
FE lock.....	77
File numbering.....	108
Fireworks (shooting mode).....	52
Fish-eye effect (shooting mode).....	54
Flash	
Deactivating flash.....	42, 77
On.....	77
Slow synchro.....	77
Focus check.....	83
Focusing	
AF frames.....	74
AF lock.....	76
AF-point zoom.....	46
Servo AF.....	76
Focusing range	
Macro.....	72
Manual focus.....	72
Focus lock.....	74
FUNC. menu	
Basic operations.....	25
Table.....	141, 146

## G

GPS.....	29, 82
Grid lines.....	46

## H

Handheld nightscene (shooting mode).....	52
HDMI cable.....	115
Household power.....	118

## I

i-Contrast.....	69, 100
iFrame movies (movie mode).....	64
Image quality → Compression ratio (image quality)	
Images	
Display period.....	48
Erasing.....	90
Playback → Viewing	
Protecting.....	87
Image stabilization.....	78
Indicator.....	27
ISO speed.....	69

## L

Lamp.....	47, 48
Long shutter (shooting mode).....	62
Low light (shooting mode).....	52

## M

Macro (focusing range).....	72
Magnified display.....	85
Manual focus (focusing range).....	72
Memory cards.....	2 → Memory cards
Recording time.....	148

Before Use

Basic Guide

Advanced Guide

Camera Basics

Using GPS Functions

Auto Mode

Other Shooting Modes

P Mode

Playback Mode

Setting Menu

Accessories

Appendix

Index



Menu	
Basic operations.....	26
Table.....	140
Metering method.....	68
Miniature effect (shooting mode).....	55
Monochrome (shooting mode).....	56
Movie Digest (shooting mode).....	59
Movies	
Editing.....	101
Image quality (resolution/frame rate).....	44, 45, 64
Recording time.....	148
My Category.....	95
My Colors.....	70, 99
<b>P</b>	
Package contents.....	2
Photobook set-up.....	128
PictBridge.....	115, 122
Playback → Viewing	
Portrait (shooting mode).....	51
Poster effect (shooting mode).....	54
Power.....	114
→ AC adapter kit	
→ Battery pack	
→ Battery charger	
Powered IS.....	78
Power saving.....	23
Printing.....	122 → Printing
Program AE.....	67
Protecting.....	87
P (shooting mode).....	67

<b>R</b>	
Red-eye correction.....	44, 100
Reset all.....	110
Resizing images.....	97
Resolution (image size).....	44
Rotating.....	93

<b>S</b>	
Saving images to a computer.....	121
Screen	
Display language.....	17
Icons.....	137, 138
Menu → FUNC. menu, Menu	
SD/SDHC/SDXC memory cards → Memory cards	
Searching.....	84
Self-timer.....	40
2-second self-timer.....	41
Customizing the self-timer.....	41
Face self-timer (shooting mode) ...	61
Wink self-timer (shooting mode) ...	61
Sepia tone images.....	70
Servo AF.....	76
Shooting	
Shooting date/time → Date/time	
Shooting information.....	137
Slideshow.....	86
Smart Shuffle.....	87
Smart Shutter (shooting mode).....	60
Smile (shooting mode).....	60
Snow (shooting mode).....	51

Software	
Installation.....	120
Saving images to a computer.....	121
Sounds.....	104
Stereo AV cable.....	115, 117
Stitch Assist (shooting mode).....	63
Strap.....	2, 12
Super slow motion movie (movie mode).....	64
Super vivid (shooting mode).....	54

<b>T</b>	
Terminal.....	116, 117, 122
Toy camera effect (shooting mode).....	56
Tracking AF.....	75
Traveling with the camera.....	109
Troubleshooting.....	133
TV display.....	115

<b>U</b>	
Underwater (shooting mode).....	51

<b>V</b>	
Viewing.....	20
Image search.....	84
Index display.....	83
Magnified display.....	85
Single-image display.....	20
Slideshow.....	86
Smart Shuffle.....	87
TV display.....	115

<b>W</b>	
White balance (color).....	69
Widescreen (resolution).....	44
Wink self-timer (shooting mode).....	61
World clock.....	109
Wrist strap → Strap	
<b>Z</b>	
Zoom.....	18, 35, 40

Before Use

Basic Guide

Advanced Guide

Camera Basics

Using GPS  
Functions

Auto Mode

Other Shooting  
Modes

P Mode

Playback Mode

Setting Menu

Accessories

Appendix

Index



### Use of genuine Canon accessories is recommended.

This product is designed to achieve excellent performance when used with genuine Canon accessories.

Canon shall not be liable for any damage to this product and/or accidents such as fire, etc., caused by the malfunction of non-genuine Canon accessories (e.g., a leakage and/or explosion of a battery pack). Please note that this warranty does not apply to repairs arising out of the malfunction of non-genuine Canon accessories, although you may request such repairs on a chargeable basis.

Note that availability varies by area, and some accessories may no longer be available.

#### CAUTION

RISK OF EXPLOSION IF BATTERY IS REPLACED BY AN INCORRECT TYPE.  
DISPOSE OF USED BATTERIES ACCORDING TO LOCAL REGULATION.

#### Battery Charger CB-2LY

**IMPORTANT SAFETY INSTRUCTIONS-  
SAVE THESE INSTRUCTIONS.  
DANGER-TO REDUCE THE RISK OF  
FIRE OR ELECTRIC SHOCK, CAREFULLY  
FOLLOW THESE INSTRUCTIONS.**

If the shape of the plug does not fit the power outlet, use an attachment plug adaptor of the proper configuration for the power outlet.



#### USA and Canada only:

The Lithium ion/polymer battery that powers the product is recyclable. Please call 1-800-8-BATTERY for information on how to recycle this battery.

#### FCC Notice

(Digital Camera, Model PC2063 systems)

This device complies with Part 15 of the FCC Rules. Operation is subject to the following two conditions;

- (1) this device may not cause harmful interference, and
- (2) this device must accept any interference received, including interference that may cause undesired operation.

Note: This equipment has been tested and found to comply with the limits for Class B digital devices, pursuant to Part 15 of the FCC rules. These limits are designed to provide reasonable protection against harmful interference in a residential installation.

This equipment generates, uses and can radiate radio frequency energy and, if not installed and used in accordance with the instructions, may cause harmful interference to radio communications. However, there is no guarantee that interference will not occur in a particular installation. If this equipment does cause harmful interference to radio or television reception, which can be determined by turning the equipment off and on, the user is encouraged to try to correct the interference by one or more of the following measures:

- Reorient or relocate the receiving antenna.
- Increase the separation between the equipment and receiver.
- Connect the equipment into an outlet on a circuit different from that to which the receiver is connected.
- Consult the dealer or an experienced radio/TV technician for help.

The cable with the ferrite core provided with the digital camera must be used with this equipment in order to comply with Class B limits in Subpart B of Part 15 of the FCC rules.

Do not make any changes or modifications to the equipment unless otherwise specified in the manual. If such changes or modifications should be made, you could be required to stop operation of the equipment.

Canon U.S.A., Inc.

One Canon Park, Melville, New York 11747, U.S.A.

Tel No. 1-800-OK-CANON (1-800-652-2666)

Before Use

Basic Guide

Advanced Guide

Camera Basics

Using GPS Functions

Auto Mode

Other Shooting Modes

P Mode

Playback Mode

Setting Menu

Accessories

Appendix

Index





## Canadian Radio Interference Regulations

CAN ICES-3 (B)/NMB-3 (B)

To ensure proper operation of this product, use of genuine Canon accessories is recommended.

### For CA, USA only

Included lithium battery contains Perchlorate Material - special handling may apply. See [www.dtsc.ca.gov/hazardouswaste/perchlorate/](http://www.dtsc.ca.gov/hazardouswaste/perchlorate/) for details.

## Trademarks and Licensing

- Microsoft and Windows are trademarks or registered trademarks of Microsoft Corporation in the United States and/or other countries.
- Macintosh and Mac OS are trademarks of Apple Inc., registered in the U.S. and other countries.
- The SDXC logo is a trademark of SD-3C, LLC.
- HDMI, the HDMI logo and High-Definition Multimedia Interface are trademarks or registered trademarks of HDMI Licensing, LLC.
- The iFrame logo and the iFrame symbol are trademarks of Apple Inc.
- All other trademarks are the property of their respective owners.
- This device incorporates exFAT technology licensed from Microsoft.
- This product is licensed under AT&T patents for the MPEG-4 standard and may be used for encoding MPEG-4 compliant video and/or decoding MPEG-4 compliant video that was encoded only (1) for a personal and non-commercial purpose or (2) by a video provider licensed under the AT&T patents to provide MPEG-4 compliant video. No license is granted or implied for any other use for MPEG-4 standard.

## Disclaimer

- Reprinting, transmitting, or storing in a retrieval system any part of this guide without the permission of Canon is prohibited.
- Canon reserves the right to change the contents of this guide at any time without prior notice.
- Illustrations and screenshots in this guide may differ slightly from the actual equipment.
- The above items notwithstanding, Canon accepts no liability for damages due to mistaken operation of the products.

Before Use

Basic Guide

Advanced Guide

Camera Basics

Using GPS Functions

Auto Mode

Other Shooting Modes

P Mode

Playback Mode

Setting Menu

Accessories

Appendix

Index

