

460/465

LED TV

Installation manual

imagine the possibilities

Thank you for purchasing this Samsung product.
To receive more complete service, please
register your product at

www.samsung.com/register

Model _____ Serial No. _____



Figures and illustrations in this User Manual are provided for reference only and may differ from actual product appearance. Product design and specifications may be changed without notice.

Still image warning

Avoid displaying still images (like jpeg picture files) or still image elements (like TV Programme such as TV Programmeme logos, the panorama or 4:3 image format, stock or news bars at the bottom of the screen etc.) on the screen. Constantly displaying still pictures can cause uneven wear of the screen phosphor, which will affect the image quality. To reduce risk of this effect, please follow the recommendations below:

- Avoid displaying the same TV channel for long periods.
- Always try to display any image over the full screen, use the TV set picture format menu for the best possible match.
- Reduce the brightness and contrast values to the minimum require values to achieve the desired picture quality. Exceeding these values may speed up the burnout process.
- Frequently use all TV features designed to reduce image retention and screen burnout, refer to the appropriate user manual section for more details.

Securing the Installation Space

Keep the required distances between the product and other objects (e.g. walls) to ensure proper ventilation. Failing to do so may result in fire or a problem with the product due to an increase in the internal temperature of the product.

- When using a stand or wall-mount, use parts provided by Samsung Electronics only.
 - If you use parts provided by other manufacturers, it may result in a problem with the product or an injury due to the product falling.
- The appearance may differ depending on the product.

Installation with a stand.

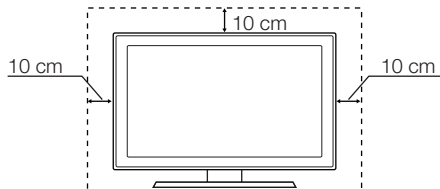

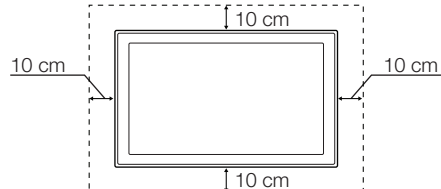

Installation with a wall-mount.



Contents

- Still image warning..... 2
- Securing the Installation Space..... 2
- Accessories..... 4
- Installing the LED TV Stand..... 4
- Viewing the Connection Panel 6
- Using the TV's Controller 9
- Viewing the Remote Control 10
- Connecting the MediaHub HD..... 12
- Connecting the RJP (Remote Jack Pack) 13
- Setting the Hotel Option Data 15
- Installing the Wall Mount 39
- Securing the TV to the Wall..... 40
- Anti-theft Kensington Lock 40
- Specifications 41

	<p>Correct Disposal of This Product (Waste Electrical & Electronic Equipment) (Applicable in the European Union and other European countries with separate collection systems)</p> <p>This marking on the product, accessories or literature indicates that the product and its electronic accessories (e.g. charger, headset, USB cable) should not be disposed of with other household waste at the end of their working life. To prevent possible harm to the environment or human health from uncontrolled waste disposal, please separate these items from other types of waste and recycle them responsibly to promote the sustainable reuse of material resources. Household users should contact either the retailer where they purchased this product, or their local government office, for details of where and how they can take these items for environmentally safe recycling. Business users should contact their supplier and check the terms and conditions of the purchase contract. This product and its electronic accessories should not be mixed with other commercial wastes for disposal.</p>
	<p>Correct disposal of batteries in this product (Applicable in the European Union and other European countries with separate battery return systems.)</p> <p>This marking on the battery, manual or packaging indicates that the batteries in this product should not be disposed of with other household waste at the end of their working life. Where marked, the chemical symbols Hg, Cd or Pb indicate that the battery contains mercury, cadmium or lead above the reference levels in EC Directive 2006/66. If batteries are not properly disposed of, these substances can cause harm to human health or the environment. To protect natural resources and to promote material reuse, please separate batteries from other types of waste and recycle them through your local, free battery return system.</p>

Accessories

- Please make sure the following items are included with your LED TV. If any items are missing, contact your dealer.
- The items' colours and shapes may vary depending on the model.
- The provided accessories may vary depending on the model.



- Remote Control & Batteries (AAA x 2)
- Power Cord
- Safety Guide (Not available in some locations)
- Holder-Wire stand
- Quick Setup Guide
- Guide Stand
- Screws
- Stand

- The stand and stand screws may not be included depending on the model.
- The Data Cable may not be included depending on the SI Vendor.

Installing the LED TV Stand

Stand Components

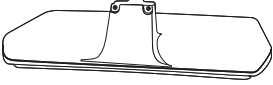
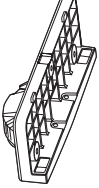
When installing the stand, use the provided components and parts.
The accessories may differ depending on the model.

<p>A 1 EA</p> 	<p>B 1 EA</p> 	<p>C</p>  <p>x8 (M4 X L14)</p>
Stand	Guide Stand	Screws

HG**EC460,HG**EC465

1

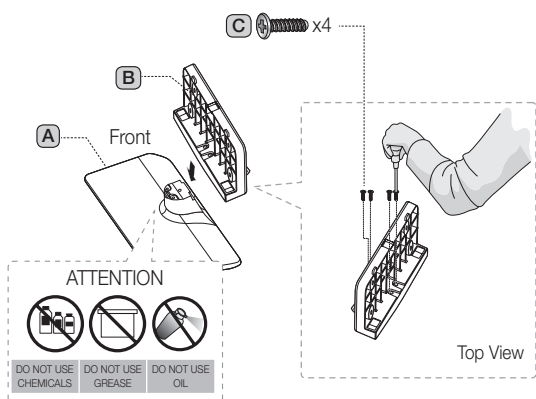

2

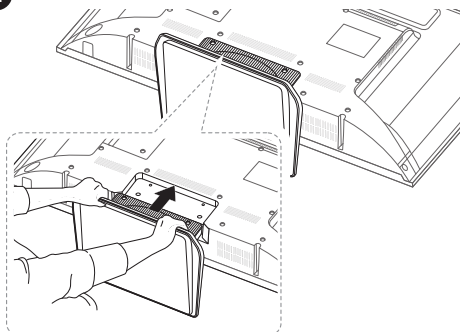

- Place a soft cloth over a table to protect the TV, and then place the TV on the cloth screen side down.
- Insert the Stand Guide into the slot on the bottom of the TV. (Stand differ depending on the model)

3

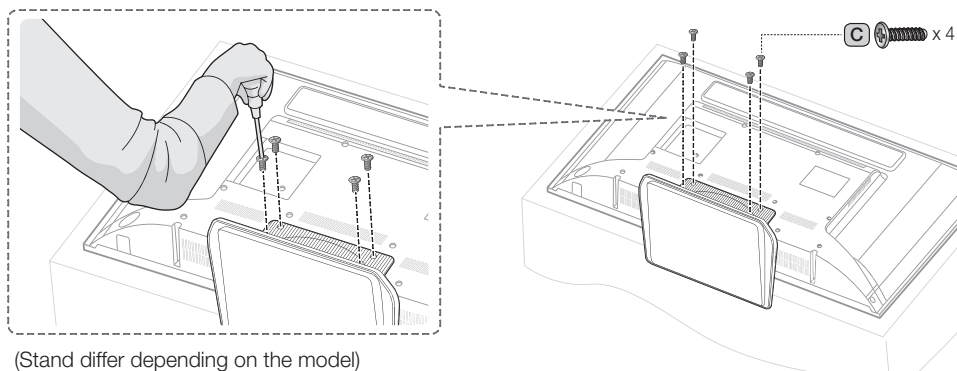

- Make sure to distinguish between the front and back of the Stand and Stand Guide when assembling them.
- Make sure that at least two people lift and move the TV.

Viewing the Connection Panel

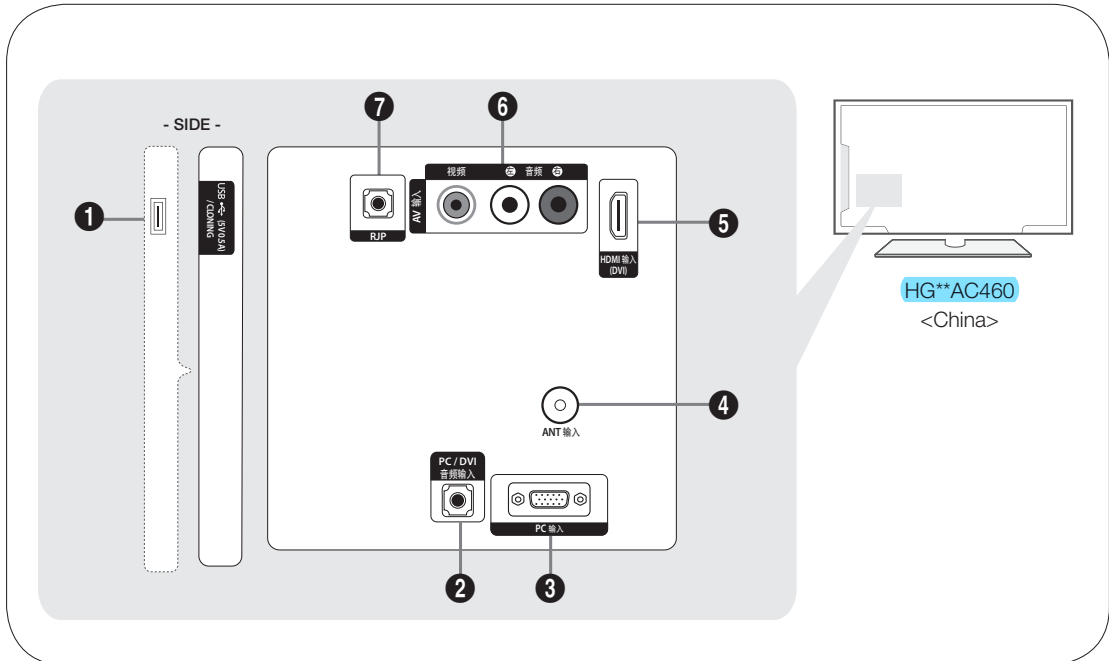
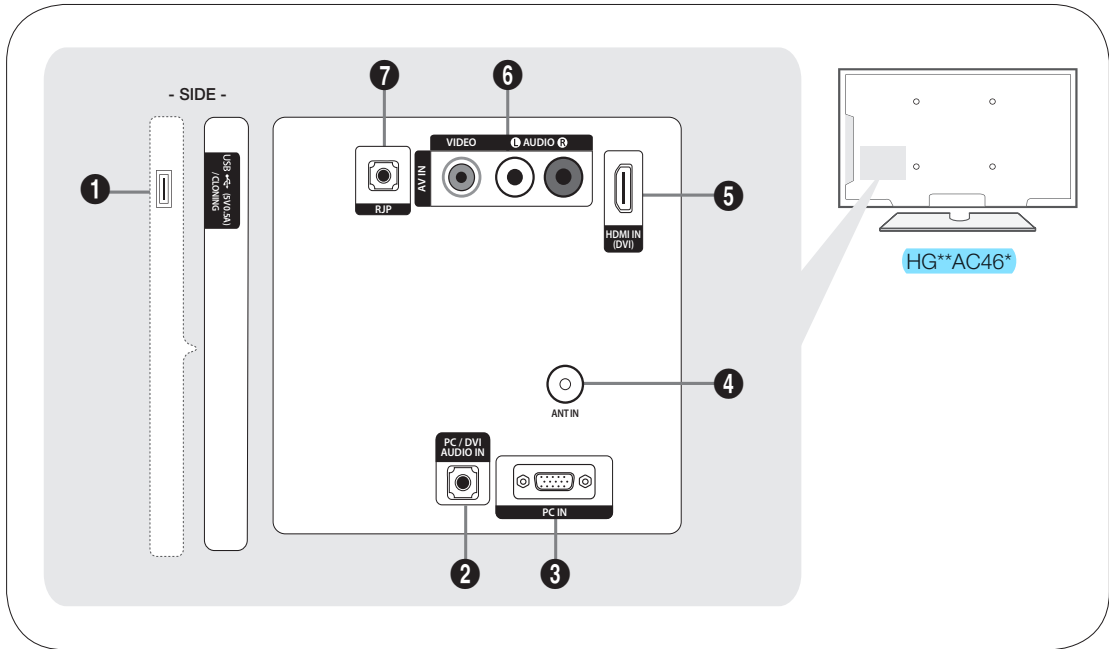

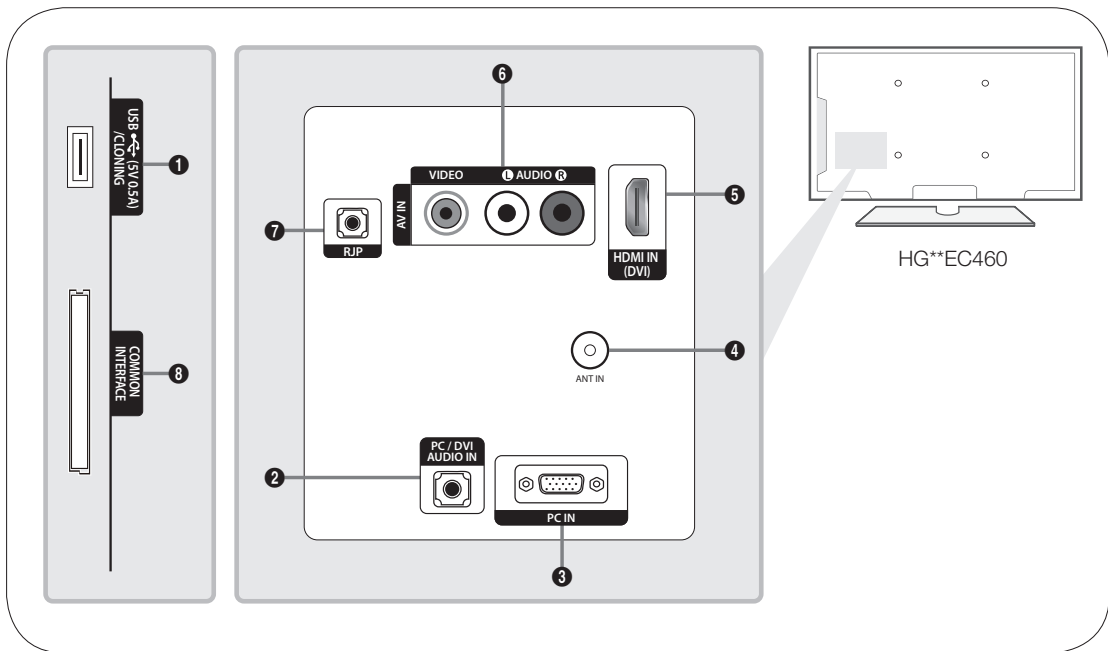

- ✎ Whenever you connect an external device to your TV, make sure that power on the unit is turned off.
- ✎ When connecting an external device, match the colour of the connection terminal to the cable.

1 USB (5V 0.5A) / CLONING

- Connector for software upgrades and Media Play, etc.
- Service connection.

2 PC/ DVI AUDIO IN: Connects to the audio input jacks on an Amplifier/Home Theater.

3 PC IN: Connect to the video output jack on your computer.

4 ANT IN, (AIR/CABLE)

- To view television channels correctly, the TV must receive a signal from one of the following sources:
- An outdoor antenna / A cable television system

5 HDMI IN: Connects to the HDMI jack of a device with an HDMI output.

- ✎ No sound connection is needed for an HDMI-HDMI connection. HDMI connections carry both audio and video.
- ✎ Use the HDMI IN (DVI) jack for a DVI connection to an external device. Use a DVI to HDMI cable or DVI-HDMI adapter (DVI to HDMI) for the video connection and the PC/DVI AUDIO IN jacks for audio.

6 AV IN

- Connect the RCA audio cables (optional) to [R - AUDIO - L] at the back of the TV set and the other ends to the corresponding audio out jacks on the DVD Player.

7 RJP: This port is an RJP (Remote Jack Pack) communication port that enables connecting different devices to additional modules to improve device use and convenience.

8 COMMON INTERFACE

Display Modes

You can also select one of the standard resolutions listed in the Resolution column. The TV will automatically adjust to the resolution you choose.

After connecting a computer to the TV, set the screen resolution for the TV on the computer. The optimal resolution is 1366 x 768 @ 60 Hz. If it is set to any other than in the table below, the TV may display nothing. Set the resolution properly, referring to the user guide of the computer or its graphic card.

The resolutions in the table are recommended.

🔗 Optimal resolution is 1366 X 768 @ 60 Hz.

Mode	Resolution	Horizontal Frequency (KHz)	Vertical Frequency (Hz)	Pixel Clock Frequency (MHz)	Sync Polarity (H / V)
IBM	720 x 400	31.469	70.087	28.322	-/+
MAC	640 x 480	35.000	66.667	30.240	-/-
	832 x 624	49.726	74.551	57.284	-/-
	1152 x 870	68.681	75.062	100,000	-/-
VESA CVT/DMT	640 x 480	31,469	59,940	25,175	-/-
	640 x 480	37,861	72,809	31,500	-/-
	640 x 480	37,500	75,000	31,500	-/-
	800 x 600	37,879	60,317	40,000	+/+
	800 x 600	48,077	72,188	50,000	+/+
	800 x 600	46,875	75,000	49,500	+/+
	1024 x 768	48,363	60,004	65,000	-/-
	1024 x 768	56,476	70,069	75,000	-/-
	1024 x 768	60,023	75,029	78,750	+/+
	1152 x 864	67,500	75,000	108,000	+/+
	1280 x 720	45,000	60,000	74,250	+/+
	1280 x 800	49,702	59,810	83,500	-/+
	1280 x 1024	63,981	60,020	108,000	+/+
	1280 x 1024	79,976	75,025	135,000	+/+
1366 x 768	47,712	59,790	85,500	+/+	

🔗 When using an HDMI/DVI cable connection, you must use the **HDMI IN (DVI)** jack.

🔗 The interlace mode is not supported.

🔗 The set might operate abnormally if a non-standard video format is selected.

🔗 Separate and Composite modes are supported. SOG is not supported.

Using the TV's Controller

The TV Controller, which is a small joystick like button at the right back of the TV, lets you control the TV without the remote control.

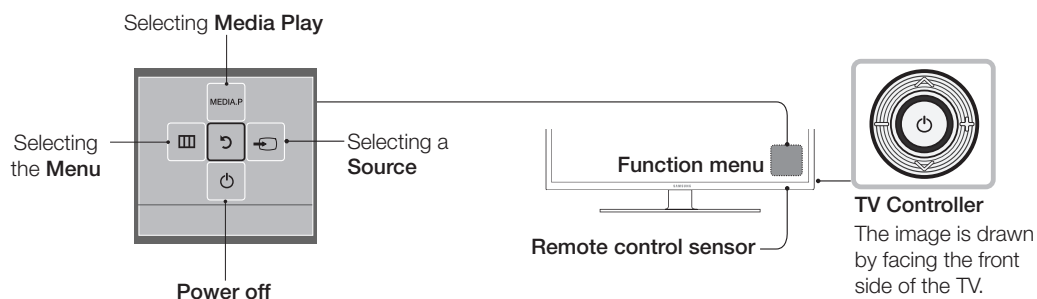

- Some functions which require a PIN code may not be available.
- The product colour and shape may vary depending on the model.
- Exits the menu when pressing the controller for longer than 1 second.
- When selecting the function by moving the controller in the up/down/left/ right directions, be sure not to press the controller. If you press it first, you cannot move it in the up/down/left/right directions.

Standby mode

Your TV enters Standby mode when you turn it off and continues to consume a small amount of electric power. To be safe and to decrease power consumption, do not leave your TV in standby mode for long periods of time (when you are away on vacation, for example). It is best to unplug the power cord.

Viewing the Remote Control

- This remote control has Braille points on the Power, Channel, and Volume buttons and can be used by visually impaired persons.

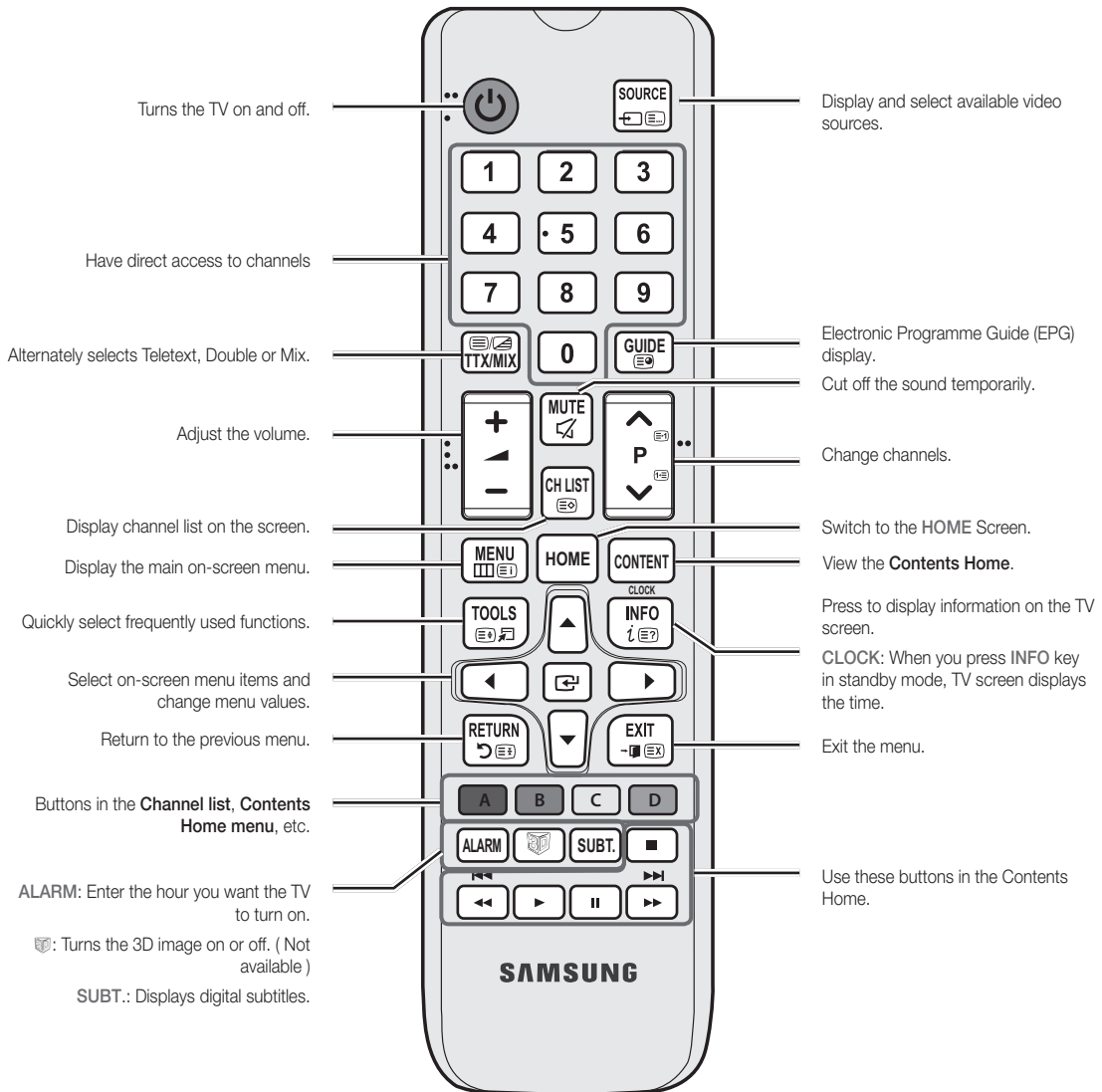

Installing batteries (Battery size: AAA)

Rear of the Remote

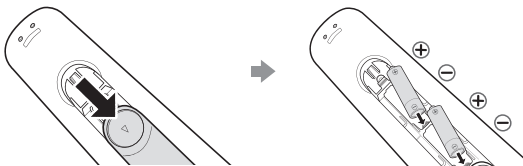

- After you have installed the batteries, use a screwdriver to screw in the screw that holds the battery cover closed.



NOTE

- Use the remote control within 23 feet of the TV.
- Bright light may affect the performance of the remote control. Avoid using nearby special fluorescent light or neon signs.
- The colour and shape may vary depending on the model.
- Remote control button 'HOME' & '3D' are not supported. When pressing these buttons, the TV unit does not respond.





10 English

Using the Football Mode (soccer mode)

Football Mode

 MENU  → Applications → Football Mode → ENTER 

This mode provides optimized condition for watching sports games.

-  (**Zoom**): Pause playback and divide the picture into 9 parts. Select a part to zoom it in. Press this button again to resume.
 -  When the Football Mode is on, the picture and sound modes are set to **Stadium** automatically.
 -  If you turn the TV off while watching **Football Mode**, the **Football Mode** will be disable.
 -  When the **Data Service** is running, the **Zoom** is not available.

Connecting the MediaHub HD

Output to any external source connected to MediaHub HD on the hotel desk.

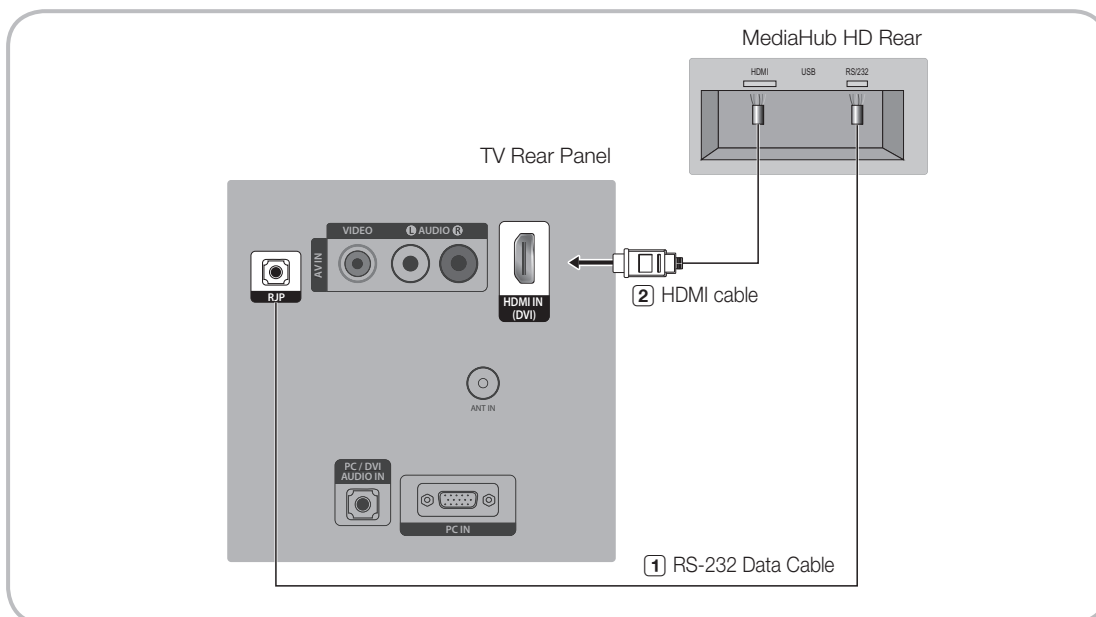

1. Connect the RJP port of the TV and the RS/232 port of the MediaHub HD.
2. Connect the HDMI IN port of the TV and the HDMI port of the MediaHub HD.

- MediaHub HD

- The MediaHub HD is a hardware module that has different Audio Video inputs (A/V, Audio, PC, HDMI and USB) and corresponding outputs. The corresponding output sources connect from MediaHub to the TV. MediaHub communicates with the TV via RS232. Hot Plug & Play is a function that allows hotel guests to connect an external source to the MediaHub. MediaHub communicates with the TV by sending messages regarding Active/Inactive sources. The TV switches to the Active external source.
- You have to connect the HDMI of the MediaHub to the HDMI IN port of the TV.
- When the TV is on, connect the TV and the RJP within 10 seconds.

- Special features

- PIP
- Auto Detection

Connecting the RJP (Remote Jack Pack)

Output to any external source connected to RJP on the hotel desk.

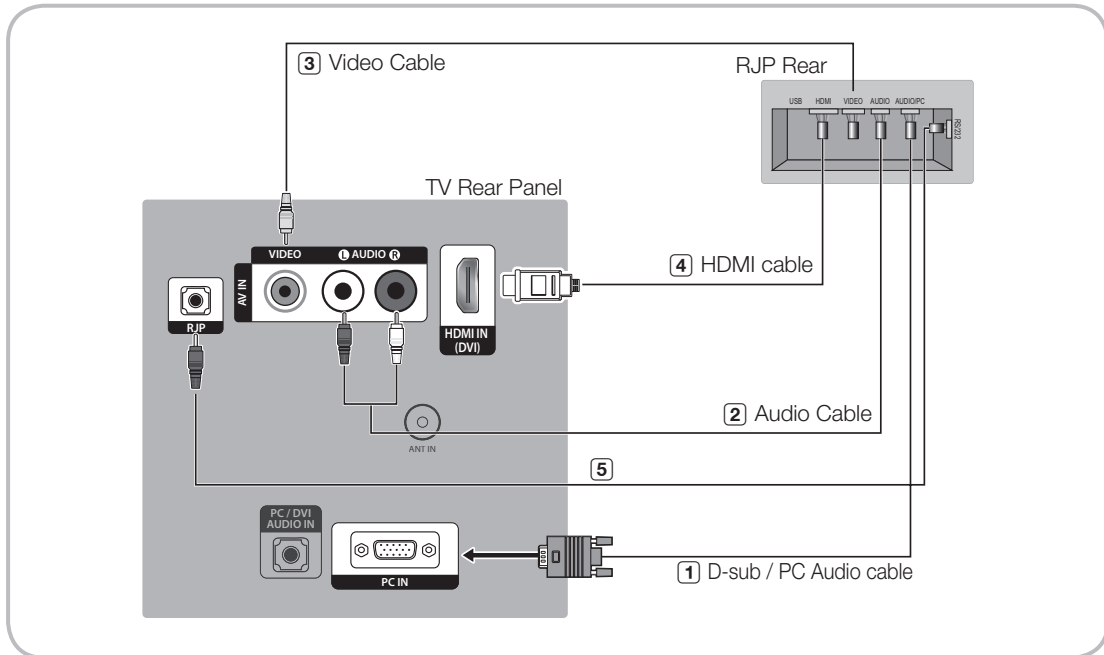

1. Connect the **PC IN / PC/DVI AUDIO IN** port of the TV to the **PC/AUDIO** port of the RJP.
2. Connect the **AV IN [VIDEO]/[L-AUDIO-R]** port of the TV to the **VIDEO** port of the RJP.
3. Connect the **AV IN [VIDEO]** port of the TV to the **VIDEO** port of the RJP.
4. Connect the **HDMI IN** port of the TV and the **HDMI** port of the RJP.
5. Connect the **RJP** port of the TV and the **RS/232** port of the RJP.
 - ✎ The RJP (Remote Jack Pack) compatible with this Samsung TV is TeleAdapt TA-7610, TA-7650 (HD) and TA-7660 (HD Plus).

- **RJP (Remote Jack Pack):** RJP stands for Remote Jack Pack. The RJP is a hardware module that has different Audio Video inputs (A/V, Audio, PC and HDMI) and corresponding outputs. The corresponding output sources are connected from the RJP to the TV. The RJP communicates with the TV via RS232. The Hot Plug & Play function allows hotel guests to connect an external source to the RJP. The RJP communicates with the TV by sending messages regarding Active/ Inactive sources. The TV will switch to the Active external source according to the priority set by the User.

- ✎ You can select **HDMI IN** and **AV IN** for connecting the RJP.
- ✎ When the TV is on, connect the TV and the RJP within 10 seconds.

- The RJP can be returned to the factory default settings by pressing the AV and HDMI buttons simultaneously for 10 seconds. All LEDs blink 5 times to acknowledge that this has been finished.
- The RJP will automatically turn off any LEDs after 5 minutes to avoid unnecessary light pollution in the hotel room. The LEDs that were turned off will turn on again if the guest touches any of the buttons and the 5 minute timer will restart. If the guest then touches another source button, the TV will change to the selected source and the corresponding LED will be lit.
- After an RJP Reset or a TV Power OFF/ON, it takes approx. 10 seconds to establish communications between the TV and the RJP.
- The following table shows the approximate time in seconds to switch from the TV to the input source, based on the priority.

✎ Scenario 1: When no inputs are connected.

Source	To Connect
AV	2 Sec
PC	0.7 Sec
HDMI	3.9 Sec

✎ Scenario 2: When two or more inputs are connected and an Input source is disconnected and then reconnected.

Source	Disconnect	To Connect	Total
AV	4.5 Sec	2 Sec	6.5 Sec
PC	0.7 Sec	0.7 Sec	1.4 Sec
HDMI	3.9 Sec	3.9 Sec	7.8 Sec

✎ E.g. If the RJP has all its live sources AV, PC and HDMI connected, AV is viewed as the highest priority. If the RJP is in HDMI mode, and a guest removes and reconnects the AV, the minimum time required to switch to the AV is 6.5 seconds.

- To connect audio (Ipod or Mp3), Music mode should be ON and Jack Ident detect should be OFF.
- AV, PC and HDMI input sources are supported.

Setting the Hotel Option Data

To Enter: Press the **MUTE** → 1 → 1 → 9 → **ENTER** buttons in order. (From the Hospitality mode, the Standalone mode is set.)

To Exit from this menu : power off and turn on again.

No	Hotel TV Function			Description
	Category	Item	initial value	
1	Hospitality Mode	Hospitality Mode	Standalone	Select Hospitality mode. • Stand-alone mode : TV works alone.
2	SI Vendor	SI Vendor	OFF	Standalone mode : OFF /Movielink/Swisscom/ Smooovie
3	Power On	Power On Channel	Last Saved	Set the default values that will be applied when the TV is turned on. • User Defined : Lets you set Power On Channel and Channel Type manually. See Power On Channel and Channel Type below. • Last Saved : If you select this item, when the TV is turned on, it displays the channel it was displaying when it was turned off.
		Power On Channel Num	...	When the TV is turned on, it switches automatically to this channel.
		Power On Channel Type	...	• Select channel band : AIR (analog air band), DTV (digital air band), CATV (analog cable band), CDTV (digital cable band)
		Power On Volume	Last Saved	• User Defined : Lets you set the Power On Volume manually. See Power On Volume below. • Last Saved : When the TV is turned on, it returns to the volume that had been set when the power had been turned off.
		Power On Volume Num	...	The TV turns on with this Volume Level in Stand Alone Hospitality mode.
		Min Volume	0	The minimum Volume Level the user can set in Stand Alone Hospitality mode.
		Max Volume	100	The maximum Volume Level the user can set in Stand Alone Hospitality mode.
		Power On Source	TV	Select the input source the TV displays when turns on.
		Power On Option	Last Option	Determines the TV's state when power returns after a power failure or after you have unplugged the TV and then plugged it in again. • LAST OPTION : Returns to its last Power state. If it was in Stand-by, it returns to Stand-by. If it was on, it turns on. • Power On : When the power returns, the TV turns on. • Standby : When the power returns, the TV enters the Standby mode.
4	Channel	Channel Setup	...	Gives you direct, immediate access to some of the Channel menu functions on the user Channel menu such as Auto Program, Antenna selection, etc.
		Channel Editor	...	The Channel Editor lets you edit the channels stored in the TV's memory. Using Channel Editor you can: • Change the channel numbers and names, and sort the channels in your desired channel number order. • Apply the video mute to channels you select. The video mute blanks out the video from a channel and outputs only the sound while displaying a speaker icon on the screen. The Channel Editor also lets you view information about each channel easily, without your having to display each channel directly.
		Mixed Channel Map	ON	This Feature enables showing/browsing all antenna type (Air/Cable or Satellite) channels at the same time. • On: When ON, guests can access the complete Channel Map irrespective of the selected antenna type. The Channel list will also populate Air as well Cable type channels. • Off: When OFF, guest can access the Channel Map corresponding to the selected antenna type [AIR/CABLE or Satellite] only. The Channel list/Editor will only show the selected antenna type channels.
		Dynamic SI	OFF	• On : Check the DTV Programme channel number. (the DTV channel editor is inaccessible) • Off: Do not check the DTV Programme channel number. (the DTV channel editor is accessible, but additional channel Programme number update is not supported)

No	Hotel TV Function			Description
	Category	Item	initial value	
4	Channel	Channel Rescan Message	ON	When there is a mismatch between the data in the channel map and the transmitted data , the TV autotunes the channels to restore the data/parameters in the channel map. <ul style="list-style-type: none"> On: When Channel Rescan Message is ON, The OSD showing that the channels are being rescanned will be displayed to Hotel Guests. Off: A Hotel Admin can turn the Channel Rescan Message OFF, if the rescan message OSD should not to be displayed to Hotel Guests.
		My Channel	OFF	Enable or disable the Mychannel feature.
		Genre Editor	...	Edit the genre for channels. (Available when Mychannel is On)
		Subtitle Auto On	OFF	This function turns the function On/Off that automatically turns on the subtitles in a specific country. This function is supported for Hotel TVs that are ready to receive DVB broadcasts that is heading to Europe. This function is related to France's subtitle specification. The rest of the countries' subtitles function according to the appropriate country specifications regardless of the Subtitle Auto On function. <ul style="list-style-type: none"> On: When the Subtitle Auto On function is ON, it follows France's subtitle specifications. Off: When the Subtitle Auto On function is OFF, it does not follow France's subtitle specifications.
		TTX Widescreen Mode	OFF	<ul style="list-style-type: none"> On : The TTX Widescreen Mode is displayed. Off :The TTX Widescreen Mode is not displayed.
5	Menu OSD	Picture Menu Lock	OFF	Enable or disable the Picture Menu.
		Menu Display	ON	<ul style="list-style-type: none"> On : The Main Menu is displayed. Off : The Main Menu is not displayed.
		Panel Button Lock	Unlock	Turning the front panel (local key) operations on/off. <ul style="list-style-type: none"> Unlock : Unlocks all panel keys. Lock : Locks all panel keys. OnlyPower : Locks all panel keys except the Power panel key. Menu/Source : Locks the Menu and Source panel keys.
		Home Menu Display	ON	<ul style="list-style-type: none"> OFF:The Home Menu is not displayed. ON:The Home Menu is displayed.
		Home Menu Editor		Edit Home Menu .
		Home Menu Auto Start	ON	<ul style="list-style-type: none"> ON:The Home Menu is Auto Start. OFF:The Home Menu is not Auto Start.
6	Clock	Local Time	Manual	Select the way to update clock data. Use clock data from a DTV channel to set the clock automatically or set the clock manually when the TV is in standalone mode.
		Time Channel Type	...	Use clock data from which DTV channel to set the clock.
		Time Channel Num	...	DTV channel Number
7	Music Mode	Music Mode AV	OFF	To get music output from an mp3/audio player through an AV Input Source. When on, you can hear sound from the player through the TV even there is no video signal. The TV's backlight, however, remains on. And add a video signal,it works normally.
		Music Mode PC	OFF	To get music output from an mp3/audio player through a PC Input Source. When on, you can hear sound from the player through the TV even there is no video signal. The TV's backlight, however, remains on. And add a video signal,it works normally.
		Music Mode Backlight	OFF	Backlight On/Off option in Music mode to save energy
8	Remote Jack Pack	Priority AV	1	If the jack priority is set, the corresponding source is automatically set when a jack is inserted according to the jack priority
		Priority PC	2	If the jack priority is set, the corresponding source is automatically set when a jack is inserted according to the jack priority.
		Priority HDMI	3	If the jack priority is set, the corresponding source is automatically set when a jack is inserted according to the jack priority.
		AV Option	AV	Select RJP AV Source (Source selection depends on Model).
		HDMI Option	HDMI	Select which HDMI source of the TV is connected to the RJP jack.

No	Hotel TV Function			Description
	Category	Item	initial value	
9	External Source	USB Pop-up Screen	Default	When a USB device is connected to the TV : <ul style="list-style-type: none"> • Default : A popup window appears. • Automatic : Opens the USB contents menu automatically. • Disable : Neither the popup window nor the menu appears.
		External Source Banner	ON	If set to On, the TV displays the External Source Banner (information) when you change the TV source to another external input, press the Info key, or turn the TV on. <ul style="list-style-type: none"> • On : The External Source information is displayed on the TV screen. • Off : The External Source information is not displayed on the TV screen.
		Auto source	OFF	<ul style="list-style-type: none"> • On : When an external input source is connected to the TV, the TV identifies the input source, and then automatically switches to that input source. • Off : Auto Source function is Off.
		Anynet+Return Source	Power On Src	Select the return TV source after stopping an Anynet+(HDMI-CEC) connection. (This function is especially useful for the Guestlink RJP)
10	Eco Solution	Energy saving	OFF	Adjusts the brightness of the TV to reduce power consumption. <ul style="list-style-type: none"> • Off: Turns off the energy saving function. • Low: Sets the TV to low energy saving mode. • Medium: Sets the TV to medium energy saving mode. • High: Sets the TV to high energy saving mode.
11	Logo/ Message	Welcome Message	OFF	Displays a the Welcome Message for 5 seconds when the TV turns On.
		Edit Welcome Message		Edits the Welcome Message.
		Hospitality Logo	OFF	Turns the Hospitality logo feature On or Off, If On, when the TV is turned on, the Logo is displayed, before the signal from the initial source, for the amount of time set in "Logo Display Time".
		Hospitality Logo DL	...	Downloads the Hospitality logo. Hospitality logo file requirements: <ul style="list-style-type: none"> • BMP or AVI files only. • Max file size : BMP - 960 X 540. AVI - 30MB. • The file can only be named samsung.bmp or samsung.avi.
		Logo Display Time	...	Hospitality Logo Display Time (3/5/7 seconds).
12	Cloning	Clone TV to USB	-	Clone the current TV options to a USB memory device.
		Clone USB to TV	-	Clone the saved TV options on a USB memory device to the TV.
		Setting Auto Initialize	OFF	When Setting Auto Initialize is set to On, and the power is turned off and on or the Master Power is turned off and on, the data is restored to the cloned values. If there is no cloned value, even when the Setting Auto Initialize is set to On, it will be ignored and the operation will be the same as that when Setting Auto Initialize is set to Off.
13	REACH Solution	REACH 3.0	OFF	<ul style="list-style-type: none"> • ON: Open the REACH 3.0 • OFF:Closed the REACH 3.0
		REACH 2.0	OFF	<ul style="list-style-type: none"> • ON: Open the REACH 2.0 • OFF:Closed the REACH 2.0
		REACH Channel	...	Select SIRCH Update Channel
		Group ID	...	Select the SIRCH Group ID
		Ticker	...	<ul style="list-style-type: none"> • On: The TICKER contents is displayed. • Off: The TICKER contents is not displayed.
		REACH Update Time	...	Select the SIRCH update Time. In the SIRCH update time , you have the option to perform an automatic upgrade at 12:00 AM/PM or at 2:00 AM/PM. You can perform hourly upgrades at an interval of either 1 hr or 2 hrs.
		REACH Update Immediate	...	<ul style="list-style-type: none"> • On : Whenever the TV enters Standby mode, always performs the SIRCH Update • Off : Only performs the SIRCH Update at the selected SIRCH Update Time
		Room Number	...	Edit the room number
		REACH 2.0 TV Sound	...	<ul style="list-style-type: none"> • On: The TV sound in the current TV source is output continuously even though the REACH 2.0 TV menu is displayed. • Off: The TV sound in the current TV source is stopped when the REACH 2.0 TV menu is displayed.
REACH 2.0 Server Version	...	Display the version of the SIRCH Clone file currently updated on the TV.		

No	Hotel TV Function			Description
	Category	Item	initial value	
15	Security	Password Input	...	Input Password 00000000.
		Password Setting	...	Set new Password.
		Password Reset	...	Reset Password to 00000000.
		Security Mode	...	Security Mode ON or OFF.
		USB	...	USB disable or Enable.
		HDMI	...	HDMI Disable or Enable.
16	System	TTX Security	...	TTX function Enable or disabl
		Self Diagnosis for TV	...	Enter Self Diagnosis Menu. <ul style="list-style-type: none"> Picture Test: Use to check for picture problems. If the problem appears in the test picture, select Yes and follow the directions on the screen. Sound Test: Use the built-in melody sound to check for sound problems. If the problem occurs during the test, select Yes and follow the directions on the screen.
		SW Update	...	SW USB Update function
		Service Pattern	OFF	Same function with SVC Service Pattern
		Contact Samsung		Contact Samsung
		TV reset	...	Factory reset

✎ REACH (Remote Enhanced Active Control for Hospitality) is a professional and interactive remote controller that lets you deliver TV firmware updates, cloning data, channel mapping changes, S-LYNK REACH contents, and TICKER contents through RF DTV to several hundred hospitality TVs simultaneously. The REACH functions are only available in standalone mode. The REACH Server is sold separately. Refer to the REACH server manual enclosed in the REACH server product for more information on operating it.

Welcome Message

The Welcome message is a feature that allows you to display customized message on the TV every time the TV is turned on by a guest in a hotel room.

- The Welcome message settings are placed in the Hotel Option Menu.
- The Welcome message should be ON in order for the message to be displayed when the power is turned on.

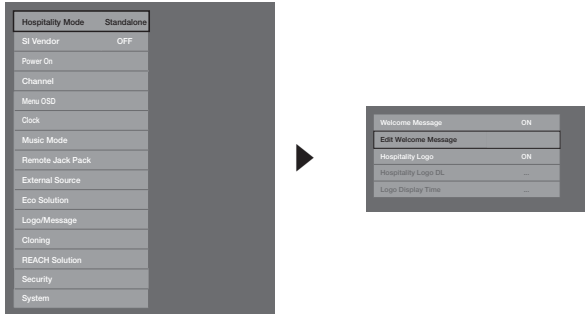

<Depending on model and region, some menu items may not exist>

- The Welcome message can be up to 25 characters and can be edited in the Hotel Service menu.
- The following is the list of characters supported for the Welcome message.
 - ✎ Only the capital letters A to Z are allowed.
- The Welcome message can be edited using the navigation, colour & enter keys of the remote control in the “Edit Welcome Message” OSD.



- The Welcome message and hotel logo cannot be active at the same time.

Hotel Logo

The Hospitality Logo function displays the Hotel's logo when the TV is powered on.

- The Hospitality Logo settings are in the Hospitality mode menus.
- The Logo Download and Logo Display Menu items are enabled when you turn the Hospitality Logo option on.
- If there is a logo image stored in the memory and the Hospitality Logo option is on, the Hospitality logo is displayed when the TV is turned on.
- The Hospitality logo is not displayed when the Hospitality Logo option is off, even if the logo image has been loaded onto the TV.

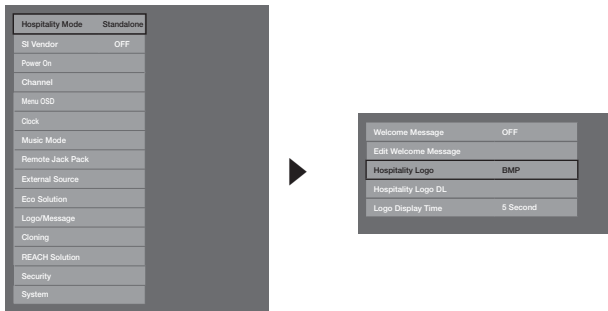

<Depending on model and region, some menu items may not exist>

• Hospitality Logo

- This option lets you choose whether the Hospitality Logo image is displayed or not.
- The Initial value is OFF.
- Can be set to OFF or ON.
- When set to ON, the Logo Download and Logo Time Display menu items become accessible.

• Hospitality Logo DL

- This option lets you download the logo image to the TV's memory from a USB device.
- The Wait message appears while the image is being copied to the TV.
- The Completed message appears when the copy operation has finished successfully.
- The Failed message appears when the copy operation was unsuccessful.
- The No USB device message appears if no USB device is connected.
- The No File message appears if there is no file to copy on the USB device or if the file is in the wrong format (must be a BMP file). If the No File message appears and there is a logo file on the USB device, check the file format.

• Logo File Format

- The TV only supports the BMP and AVI formats.
- The file name must be samsung.bmp or samsung.avi.
- The maximum resolution of the BMP format is 1280 x 720.
- The maximum file size of the AVI format is 30MB.
- The TV does not change the size or scale of the image.

Cloning

USB Cloning is a function to download user configured settings (**Picture, Sound, Input, Channel, Setup, and Hotel Setup**) from one TV set and upload the same settings to other TV sets.

All user-defined settings from the TV (Master Set) can be copied to the USB device.

- **Cloning from TV to USB:** This is an operation that copies the stored data from a specific area of the TV EEPROM to the USB device.

1. Insert a USB drive into the USB port on the back of the TV.
2. Enter the Hotel Options by pressing these buttons in the following order.
MUTE → 1 → 1 → 9 → ENTER
3. Press the **▲** or **▼** button to select "**Clone TV to USB**", then press the **ENTER** button.
4. The message "**Clone TV to USB**" is displayed, then press the **ENTER** button.
5. You can check the status of the USB cloning operation.
 - **In Progress:** While copying data to the USB device.
 - **Completed:** The copy operation was finished successfully.
 - **Failed:** The copy operation was not finished successfully.
 - **No USB:** No USB device connected.

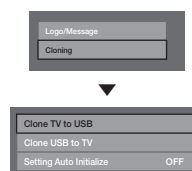
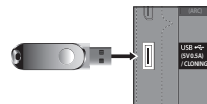

- **Clone USB to TV:** This is an operation that downloads the stored data to the USB device to the TV set.

1. Insert a USB drive into the USB port at the back of the TV.
 2. Enter the Hotel Options by pressing these buttons in the following order.
MUTE → 1 → 1 → 9 → ENTER
 3. Press the **▲** or **▼** button to select "**Clone USB to TV**", then press the **ENTER** button.
 4. The message "**Clone USB to TV**" is displayed, then press the **ENTER** button.
 5. You can check the status of the USB cloning operation
 - **In Progress:** While copying data to the USB device.
 - **Completed:** The copy operation was finished successfully.
 - **Failed:** The copy operation was not finished successfully.
 - **No USB:** No USB device connected.
 - **No File:** There is no file to copy on the USB device.
- 🔗 Activate copying from USB to TV by pressing **ENTER** key for 5 seconds.
- 🔗 The **CLONE** function only supports the same model series. (It does not work properly for different model series.)

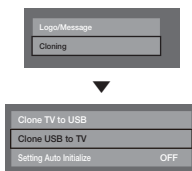

For fast, instant cloning during installation, insert a USB drive with master settings from the first TV and press the Enter key for 5 seconds.

Plug & Play

The Hotel Plug & Play function automatically performs the Hotel mode selection, Country Setup, Clock Setup and Picture mode Setup when the TV starts for the first time.

- Hotel Plug & Play is only available when the power is turned ON for the first time.
- After setting up the TV first and running Clone TV to USB.
- Next, the TV only needs to exit Hotel Plug & Play, connect to the USB device, then run Clone USB to TV.

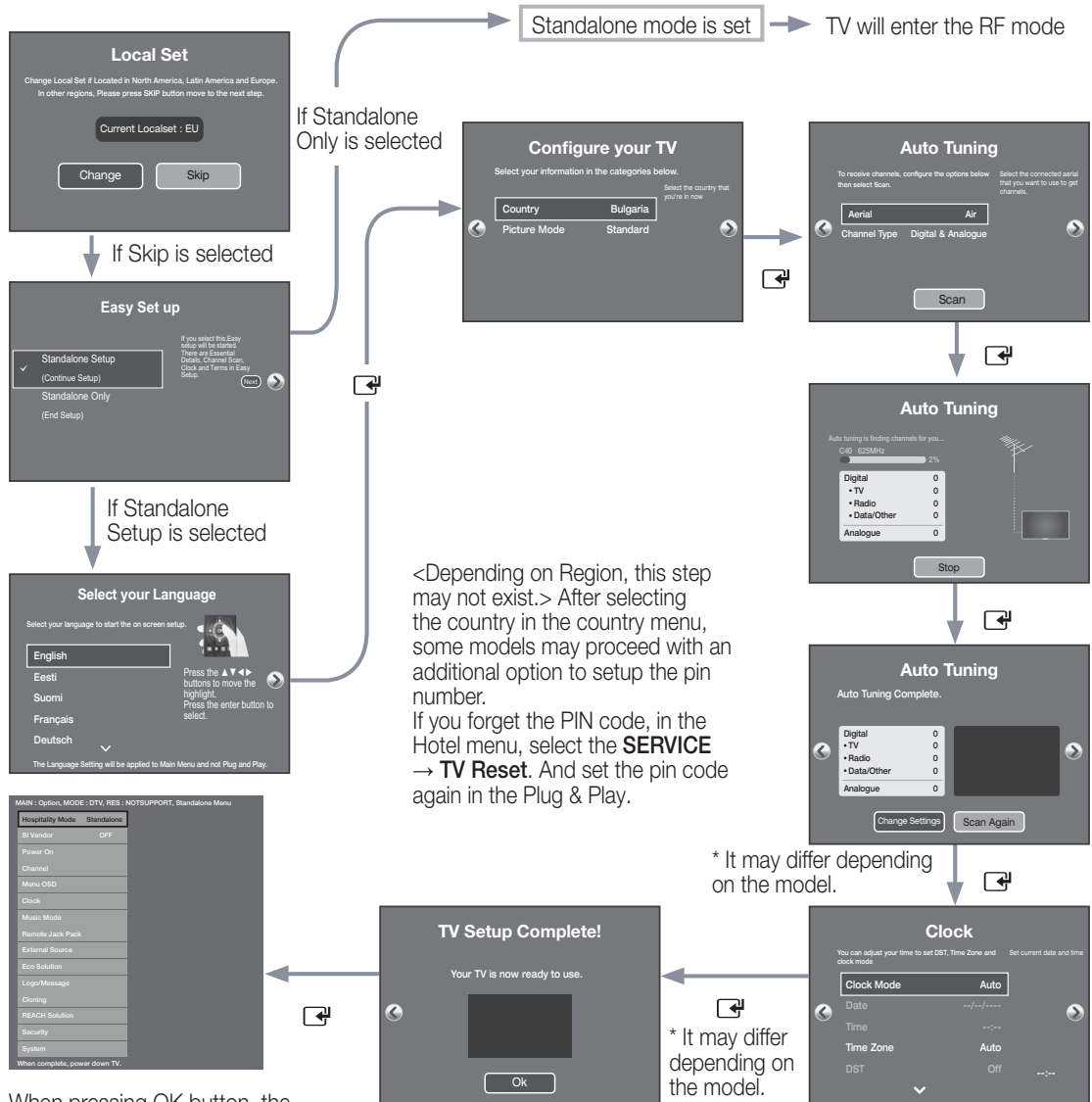

When pressing OK button, the hotel menu appears as shown on the left. Complete the hotel menu settings, and then reset the TV. You can use your TV.

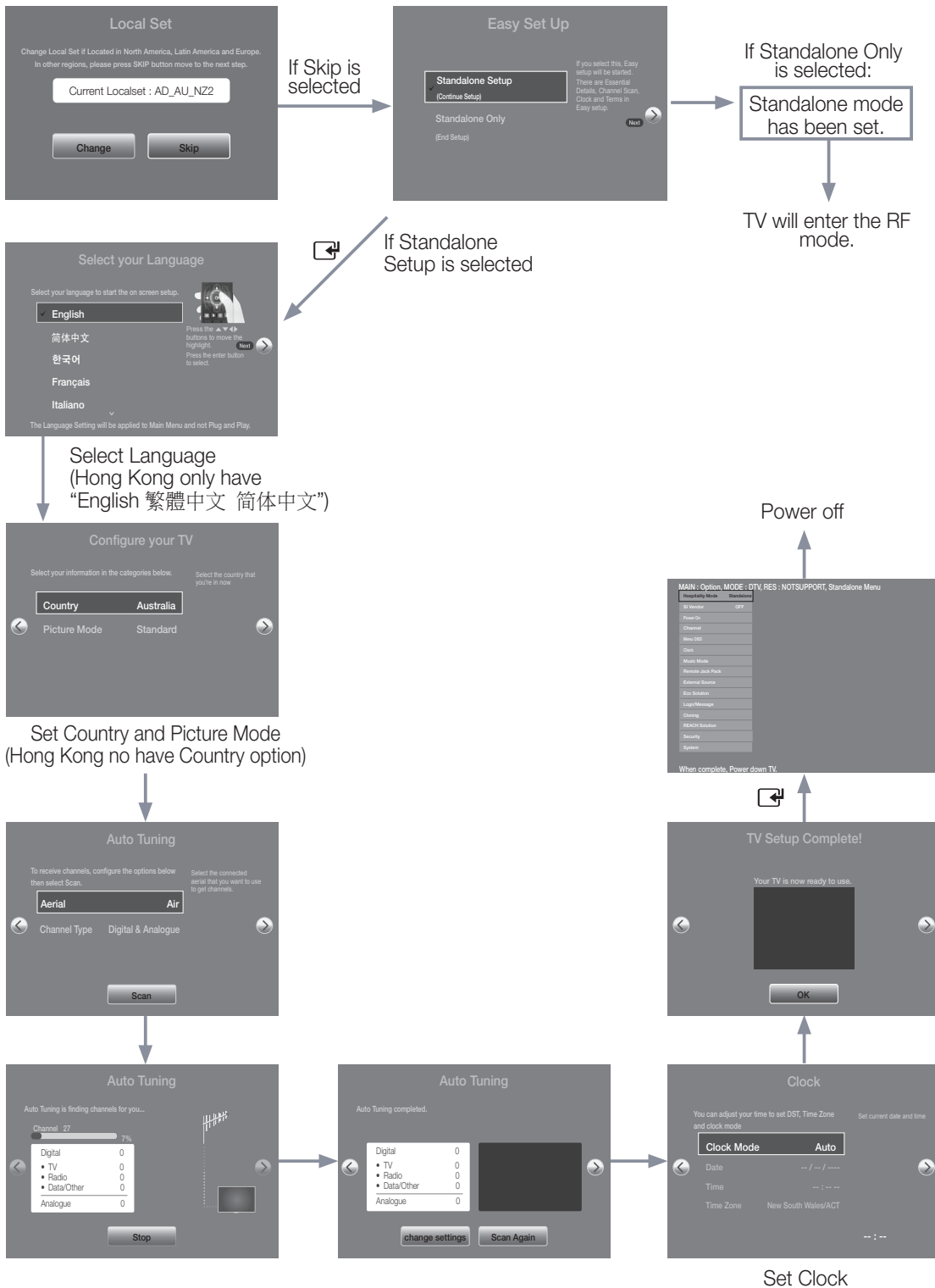

1. LocalSet

- Check the **Current Localset**.
- If you want to change the localset, select the **Change**.
- If you select the **Skip**, the **Start** screen appears.

2. Start - Easy Set Up

- If you select the **Standalone Only**, the Standalone hotel mode is set by default.
- When you select the **Interactive**, Interactive Setup Menu is displayed. Press the power off button to exit from the Interactive menu.
- Select the **Standalone Plug & Play** to go next step.

3. Select the Language

- Select the OSD (On Screen Display) language.
- Display time: The OSD timeouts and operations are the same as all of Samsung's consumer TV models.

4. Select the Country and Picture Mode

- Select the appropriate country and picture mode.
- Depending on model and region, some country may not exist.

5. Auto Tuning

- Select the antenna source and channel type. Configure the settings and select the **Scan**.
- The **Auto Tuning** operation starts searching for channels
- When the **Auto Tuning** operation is completed, the channel information is displayed.

6. Clock

- Set the right time by setting the **DST** (Daylight Savings Time) and **Time Zone**.

7. TV Setup Complete

HD Plug & Play – Local Set (Only Europe)

- Local Set is very important software setting value such as Languages, Broadcast frequencies, etc.
- TV might not function, if Local Set is not correctly configured. Select correct Local Set with country list provided.

Region	Country	Local Set	
Europe	Bulgaria Croatia Czech Estonia Greece Hungary Latvia Lithuania Romania Serbia Slovakia Slovenia EU Others	EU	
	Italy	EU_ITALY	
	Austria Germany Switzerland	EU_GER	
	France	EU_FRANCE	
	Belgium Luxembourg Netherlands	EU_BENELUX	
	Portugal Spain	EU_SPAIN	
	United Kingdom Ireland	EU_UK	
	Denmark Finland Norway Sweden	NORDIC	
	Turkey	EU_TURKEY	
	Poland	EU_POLAND	
	CIS	Kazakhstan	CIS_RUSSIA
		Russia	
		Ukraine	

Local Set change option on the first page of Region Country HD plug&play

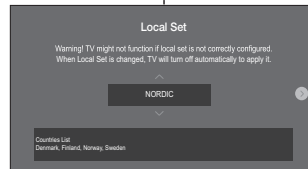
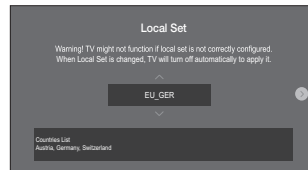
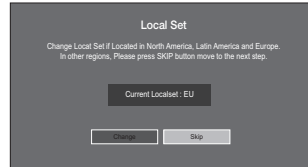

Select right Local Set with country list

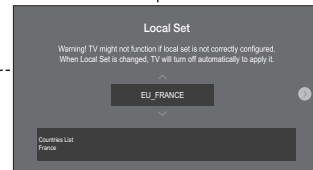
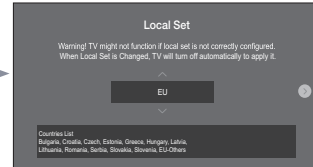

TV will reboot automatically to apply new Local Set

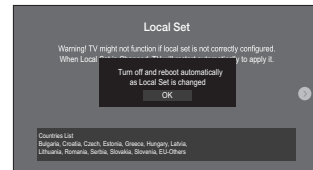

After reboot, updated Local Set is shown

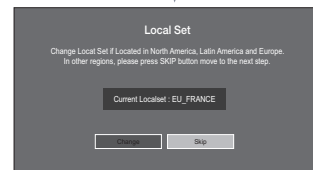

Press Skip, general HD plug&play will be continued

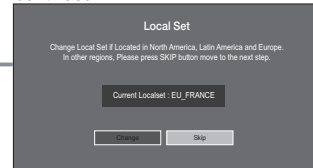

If you need to change Local Set after HD plug&play, click TV Reset function on Factory mode, you can progress HD plug&play including Local Set change.

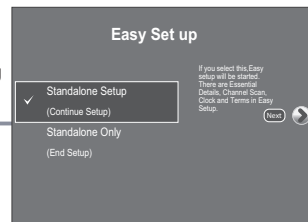
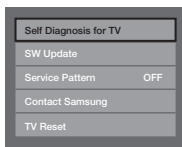

SW Clock

The SW Clock shows the current time on the screen when a user presses the Info remote control key in standby mode.

- If a user presses the Info key when the TV is in standby mode, the TV is turned on and shows the current time on the screen for 10 seconds and then returns to standby mode.
- The time is displayed as a digital clock at the normal banner size. The 12 or 24 hour time format is determined according to the format of the Information.
- If a user presses the Info key when the TV is on, the original Info key function is executed.
- Detailed Descriptions
 - The SW clock works depending on the On/Off setting in the Factory install menu.
 - If the SW clock is turned on, the Fast logo option is automatically turned off. (In this case, even if you turn the Fast logo option on again, it is automatically turned off when the TV is turned on again.)
 - If the master power is turned off, the time setting is only maintained in models with a backup condenser and an RTC.
 - When a TV in standby mode shows the current time, the video mute and audio mute settings are maintained.
 - In this case, even if the Hotel logo is set to on, the Hotel Logo display is skipped.
 - This feature only works in StandAlone mode.
 - Other key function specifications when the SW clock is running
 - The Info key works like the power key.
 - Pressing the Power or Info key while the SW clock is running, puts the TV into Standby mode.
 - Pressing keys other than the Power and Info keys is ignored while the SW clock is running.
 - In this case, the on timer does not work.
 - The off timer and sleep timer work.
 - When clock mode in the Time menu is set to manual, the time of the sub micom is maintained by the RTC circuit.
 - Even if the current time is not configured, it is displayed in the same way as the menu. (--:--)



Multi Code Remocon

Multi Code Remote Control is a special transmitter which is designed to control multiple TVs with one remote. This function is useful when there is more than one TV in one location such as a hospital. The Set ID number will be displayed in the source OSD. It is possible to support up to 9 different remote key transmission for multi code. The initial ID code of each TV is "0".

The ID code can be set and reset in Analog TV mode or PC mode. (not available in TTX or DTV channels)

- The ID code can be from 0 to 9.
- Press the **RETURN + MUTE** keys for longer than 7 seconds and the digit key you want to set.
- The Set ID OSD will be displayed in a central position.
- The following words will be displayed. "The Remote control code is set to x. If you want to change the Remote control code. Enter the digit you want to change." (x is the digit number) This OSD will be displayed until the exit key is pressed.



Remote control code is set to 0. If you want to change the Remote control code, enter the chosen digit.

- For example, the TV and Remote control will be set to ID code #1 if the user presses #1.
- The following words will be displayed. "Remote control code is changed to 1". The TV can then only be controlled by a remote control with the same ID code as the TV.
- To reset the ID code, press the **EXIT + MUTE** keys for longer than 7 seconds. The ID codes of both the TV and Remote control will be reset to "0". "Remote control code is set to 0." will be displayed.
- The way to set or reset the ID may differ depending on the remote control. See the table below.

Setting the Time



MENU → **System** → **Time** → **Clock** → **Clock Set**

- **The time is entered**
 - Press the remote control button to select **Clock** and set up the time.
 - **Setting the Interactive Mode Time**
 - If the Hotel System transmits the time information, the time is set automatically.
 - If the Hotel System does not transmit the time information, the time cannot be displayed.
- If the time is set, the clock will be displayed on the front panel.

Time

Clock

Sleep Timer Off

Wake-up Timer

Clock

Clock Mode Manual

• Clock Set

• Time Zone Auto

Channel Bank Editor (Smovie TV Only)

Channel Bank Editor is a function to edit channels with 3 different Bank Options. Depending on the Bank card, there are specific channels hotel customers can enjoy.

Setting the Channel Bank Editor in Stand-alone Mode

1. Enter the Hotel Standalone menu by pressing "MUTE+1+1+9+Enter"
2. Please select the SI vendor : "Smovie"
3. You will be able to see the new menu option "Channel Bank Editor"
4. Enter "Channel Bank Editor"

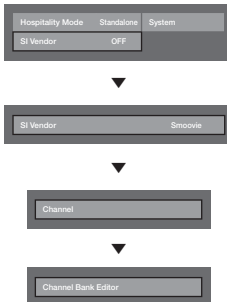

<Depending on the model and region, some menu items may not exist>

5. Edit the channel bank like in the example below.
 - a. **Bank1 (Free channel):** Select the channel that will be used when the remote control has no card.
 - b. **Bank2 (Family Card - Green):** Select the channel that will be used when a remote control has a GREEN CARD.
 - c. **Bank3 (Adult Card - Red):** Select the channel that will be used when a remote has a RED CARD.

Channel Bank Edit			
	Bank1 (4)	Bank2 (6)	Bank3 (36)
All	<input type="checkbox"/>	<input type="checkbox"/>	<input checked="" type="checkbox"/>
1 1futech	<input checked="" type="checkbox"/>	<input checked="" type="checkbox"/>	<input checked="" type="checkbox"/>
1 BBC1	<input checked="" type="checkbox"/>	<input checked="" type="checkbox"/>	<input checked="" type="checkbox"/>
2 24ore.tv	<input type="checkbox"/>	<input checked="" type="checkbox"/>	<input checked="" type="checkbox"/>
2 C3	<input type="checkbox"/>	<input checked="" type="checkbox"/>	<input checked="" type="checkbox"/>
3 BBC World	<input type="checkbox"/>	<input checked="" type="checkbox"/>	<input checked="" type="checkbox"/>
3 C5	<input type="checkbox"/>	<input checked="" type="checkbox"/>	<input checked="" type="checkbox"/>
4 Coming Soom	<input type="checkbox"/>	<input type="checkbox"/>	<input checked="" type="checkbox"/>
4 S2	<input type="checkbox"/>	<input type="checkbox"/>	<input checked="" type="checkbox"/>

References of using SMOOVIE Remote Controller

1. If you select SMOOVIE as the SI vendor, you should use a SMOOVIE Remote Controller.
2. Using the numeric keys of the remote controller, users can only select Bank1 channels. With this in mind, if you want to change the channel using a Green or Red Card, please use the channel up/down keys.
3. In the Channel guide or Channel list, users can only see the Bank1 channel list.

Channel Editor

Channel Editor edits channel number and name.

- Use Channel Editor to sort the channels as user-desired channel numbers.

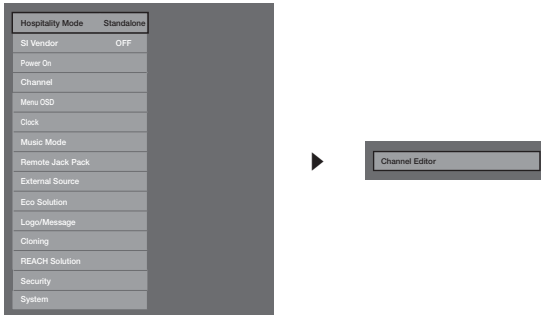

<Depending on model and region, some menu items may not exist>

Simple Steps for channel Editor under Stand-alone Mode

Step	Broad Outline
1	Operate 'Channel Auto Store' in the Hotel Option Menu
2	Enter 'Channel Editor' in the Hotel Option Menu
3	Compile a table related to the final channel lists you want
4	Rearrange channels with TOOLS button based on the table you compiled
5	Press the EXIT or RETURN Button to exit.

<For better comprehension, please refer to the following details>

My Channel

Determines the country and genre for the channels provided by the hotel, and if the user selects a country and genre, shows the corresponding channels.

- You must select the country first, or you cannot set a genre.
- If you select the genre that not added any channels, the Channel list displays all of the available channels.
- My Channel works in Standalone mode only.
- SI Vendor in Standalone mode: This does not work if Smoovie is selected.
- This is in the Hotel Options in the Hotel Menu -> Service Mode and can be turned on or off.
- This option only works when it is set to On.

Channel Composition [Genre Mode]

Standard	Category	Ch. Mode	Antenna Mode Activation		Description
			Air/Cable	Satellite(HC675)	
Hotel	Genre	All (Default)	○	○	Provide genre channel mode by each country that master has managed in factory mode.
		News	○	○	
		Radio	○	○	
		Entertainment	○	○	
		Sport	○	○	
		Hotel	○	○	

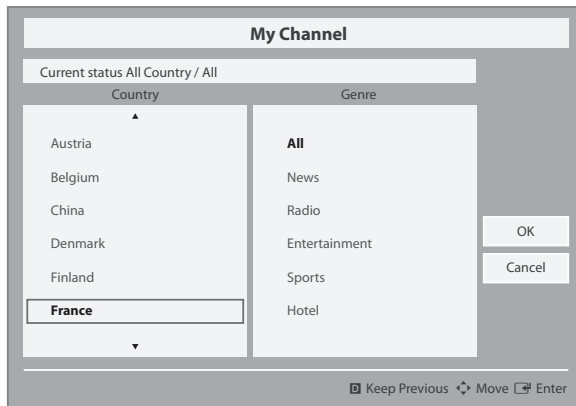

* For the number of items to be displayed in the list, refer to the design document.

Key Guide

Button	Action	Nav. Help
BLUE	Returns to the screen. (Genre setup: Last Country & Genre)	Keep Previous
ENTER	Selects an item.	Enter
Ch. Up/Down	Move the highlight by page.	(No Guide)
UP/DOWN	Navigates the each country, genre list. (in a circular manner.)	Move
RIGHT	Selects the highlighted item, and then move the highlight to Genre section.	
RETURN	Returns to the screen. (Genre setup: Last Country & Genre)	(No Guide)
EXIT	Returns to the screen. (Genre setup: Last Country & Genre)	(No Guide)

📎 Notes

- This section describes the layout of the Front UI that appears when the TV is turned on. (Factory Mode > Genre Mode: Enable)
- The genre is a sub-list for each country.
- The broadcast screen that was being displayed the last memorial channel.
- If user want to keep the previous country & genre channel map, press the 'BLUE', **RETURN**, and **EXIT** remote-control key to close the Front UI.

📎 Etc.

- Default Highlight : Last Memory items (Country, Genre)
- Timeout (60 sec)

Elements

No	Name	Description
1	Background Screen	Displays the last memorized channel that appears when TV is turned on.
2	Function Title	This is name of the function.
3	Current Status	Display current settings the Country/Genre.
4	Country Items	The item for the country list is displayed. Displays the last selected country.
5	Genre Items	The item for the genre list is displayed. Displays available genre items by each country that master managed in factory mode. (always provide 'All' item) Displays the last selected genre.
6	Highlight	If the item title is too long to be displayed within the area, Auto Text Sliding works.
7	Indicator	This is displayed when there is a previous or next page.
8	Nav. Help	The key guide is right-aligned.

Highlight Interaction [Country Items]

- This page is only to indicate possible interactions. It may not be exactly identical to actual screens.

Notes

- Users can navigate the items in each country & genre list by pressing the up or down remote control keys.
- Circular navigation is supported.

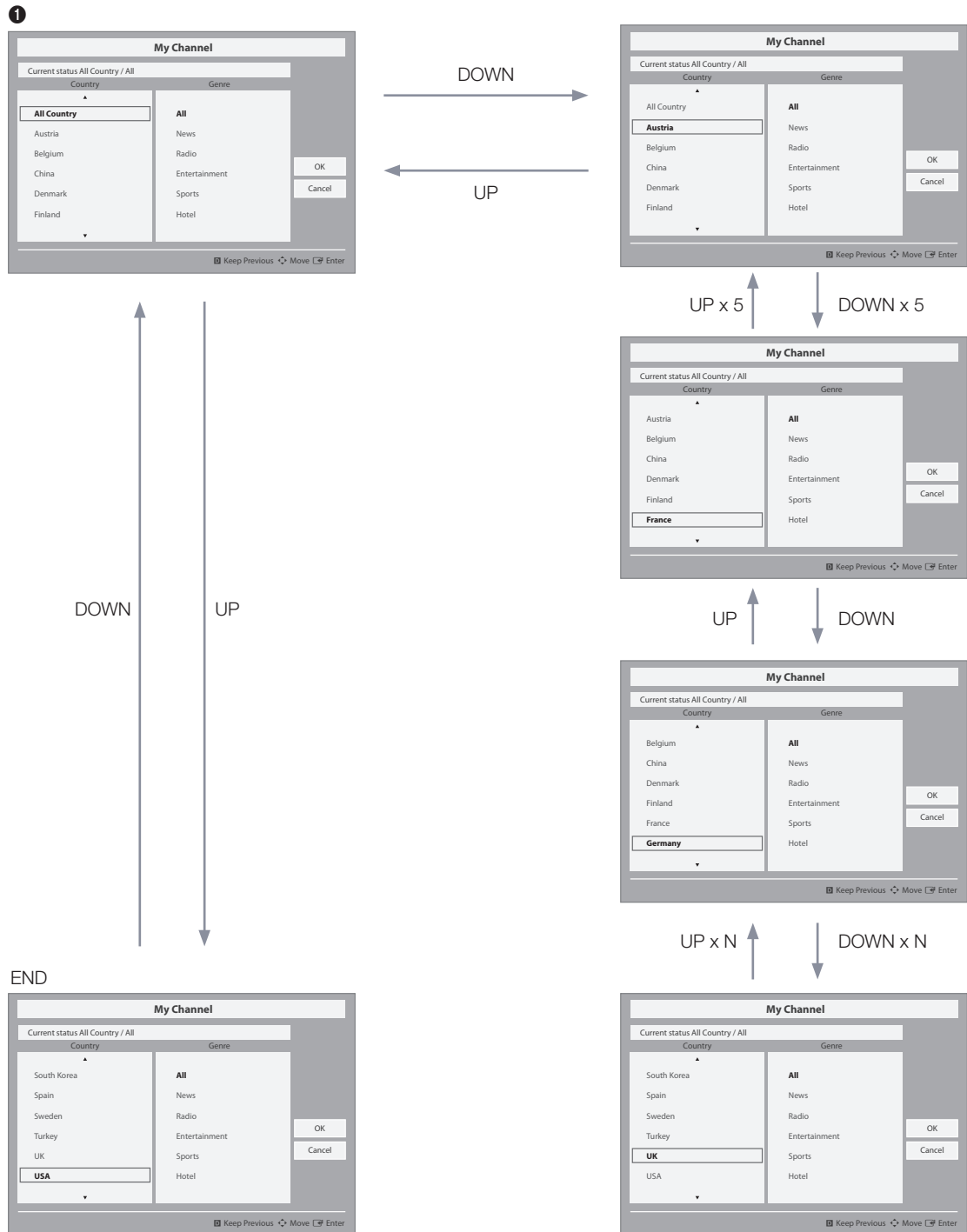

Highlight Interaction [Default Genre]

- This page is only to indicate possible interactions. It may not be exactly identical to actual screens.

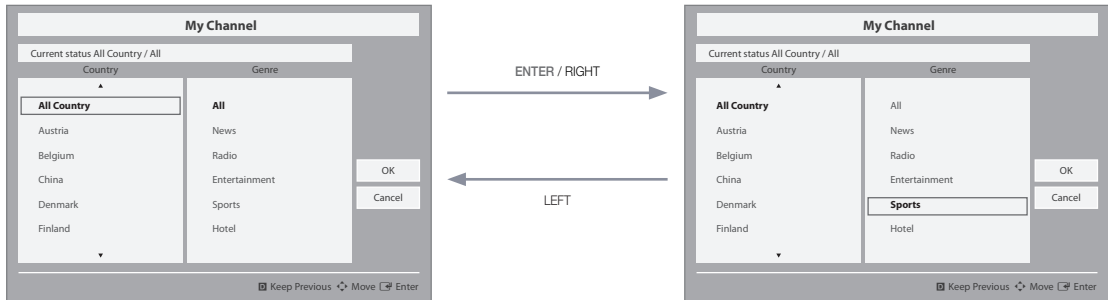

- The current selection of the country is high-lighted.
- Default High-light: The current selection of the genre.

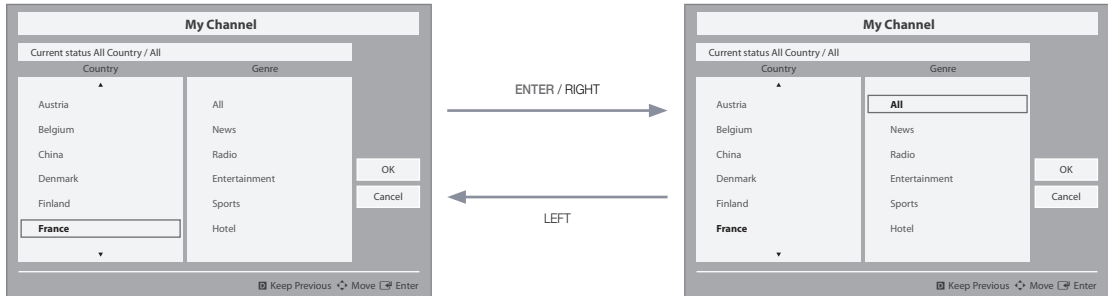

- Seems source error, it should be read as "The other item of the county is high-lighted.". Please verify. (ex. France)
- Default Highlight : All

Mode Change Interaction 1 (1/2)

- This page is only to indicate possible interactions. It may not be exactly identical to actual screens.

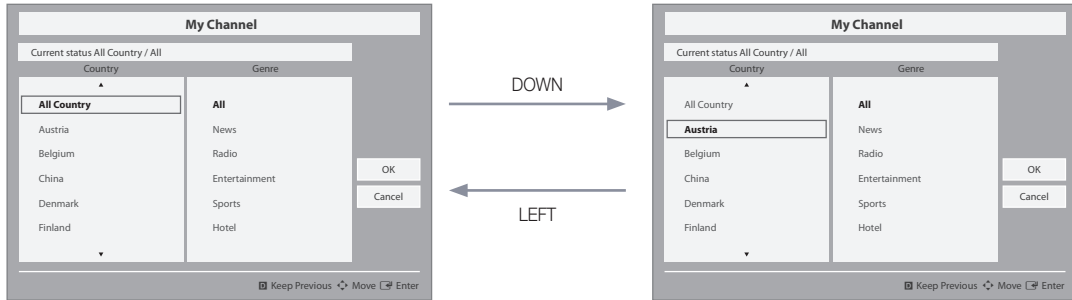

- Current Genre Mode : All Country / Sports

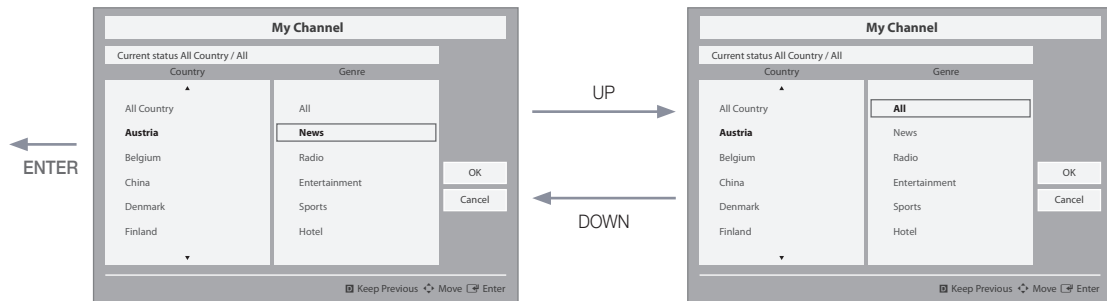

- If the country is selected, highlight moves to genre menu automatically.



Mode Change Interaction 1 (2/2)

- This page is only to indicate possible interactions. It may not be exactly identical to actual screens.

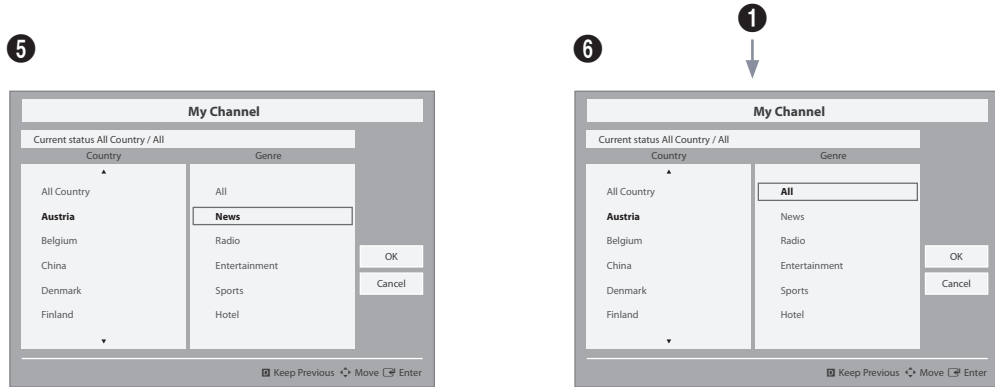

- The genre mode change complete message is displayed.
- Timeout(5 sec.)
- Pressing the left key from the genre to country menu highlights an existing selected country item.

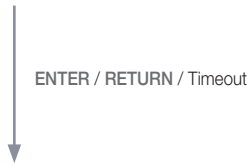

Mode Change Interaction 2 (1/2)

- This page is only to indicate possible interactions. It may not be exactly identical to actual screens.

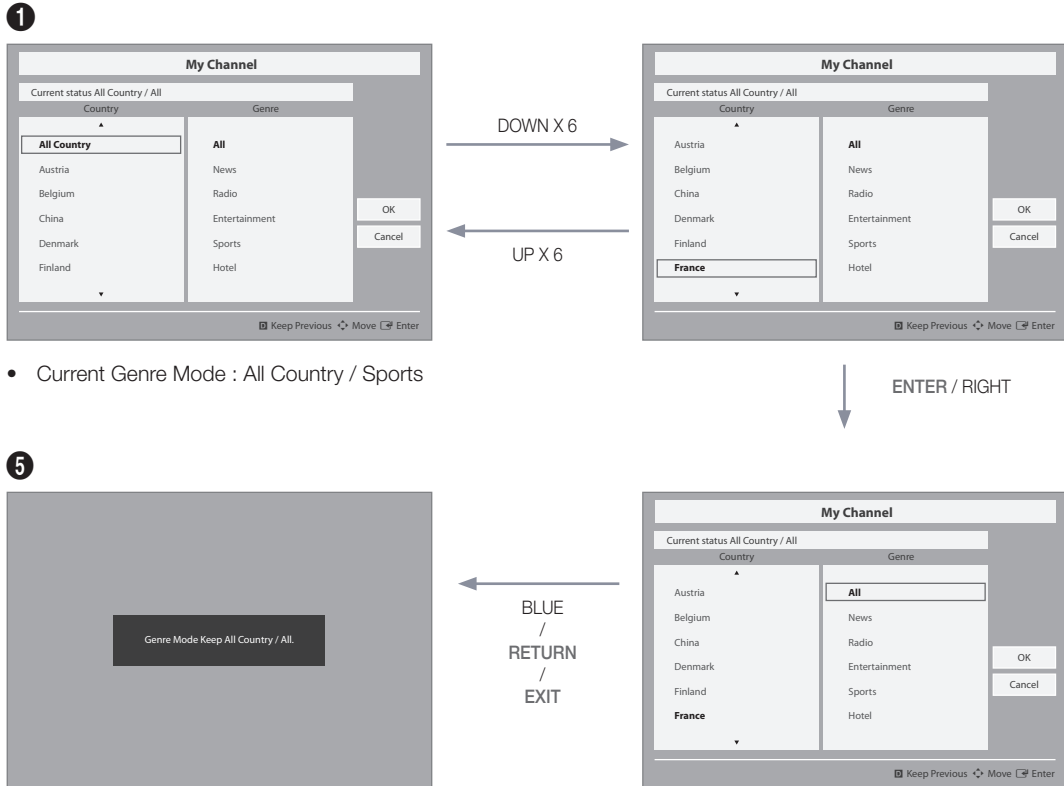

- Current Genre Mode : All Country / Sports

- Current Genre Mode : All Country / Sports

- If the country is selected, highlight moves to genre menu automatically.

Power On Scenario [Last Memory]

- This page is only to indicate possible interactions. It may not be exactly identical to actual screens.

①

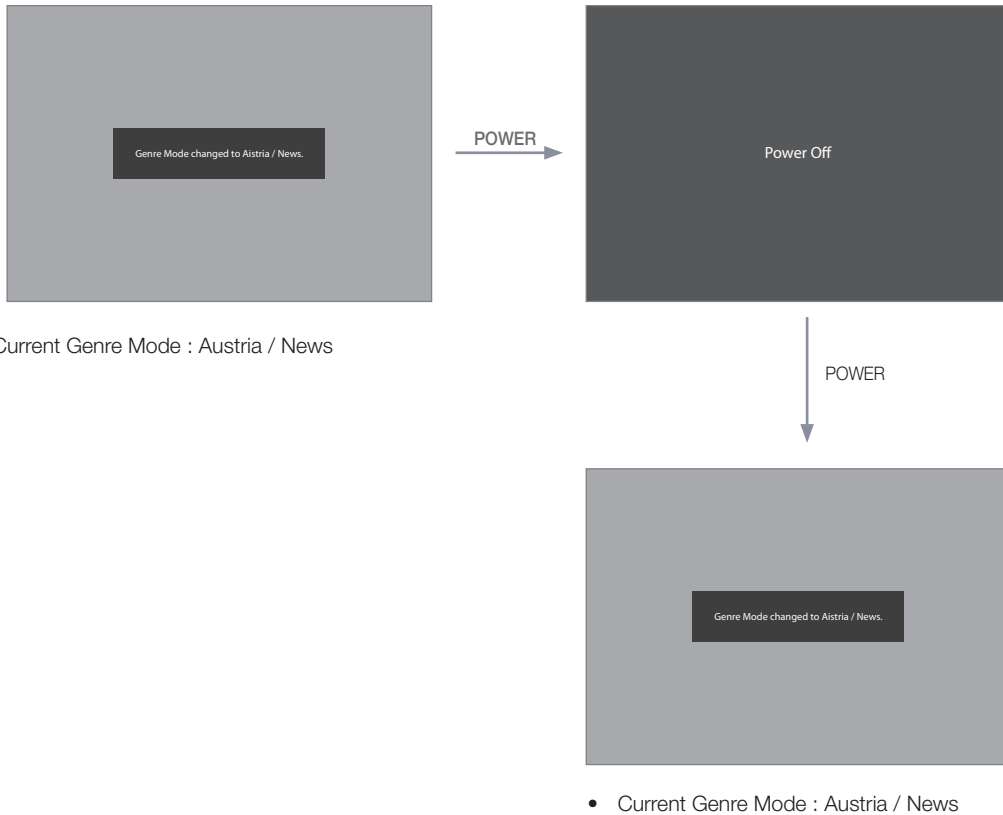

Installing the Wall Mount

The wall mount kit (sold separately) allows you to mount the TV on the wall. For detailed information on installing the wall mount, see the instructions provided with the wall mount. Contact a technician for assistance when installing the wall mount bracket. We do not advise you to do it yourself.

Samsung Electronics is not responsible for any damage to the product or injury to yourself or others if you select to install the TV on your own.

Wall Mount Kit Specifications (VESA)

The Wall mount kit is not supplied but sold separately.

Install your wall mount on a solid wall, perpendicular to the floor. When attaching to other building materials, please contact your nearest dealer. If installing on a ceiling or slanted wall, it may fall and result in severe personal injury.

NOTE

- Standard dimensions for wall mount kits are shown in the table below.
- When purchasing our wall mount kit, a detailed installation manual and all parts necessary for assembly are provided.
- Do not use screws that do not comply with VESA standard screw specifications.
- Do not use screws longer than the standard dimensions, as they may cause damage to the inside of the TV set.
- For wall mounts that do not comply with the VESA standard screw specifications, the length of the screws may differ depending on their specifications.
- Do not fasten the screws too tightly. This may... damage the product or cause the product to fall, leading to personal injury. Samsung is not liable for these kinds of accidents.
- Samsung is not liable for product damage or personal injury when a non-VESA or non-specified wall mount is used or the consumer fails to follow the product installation instructions.
- Do not exceed a 15 degrees tilt when mounting this TV.

TV size in inch	VESA screw hole specs (A * B) in millimeters	Standard Screw	Quantity
40 inch	200 x 200	M8	4
48 inch	200 x 200		

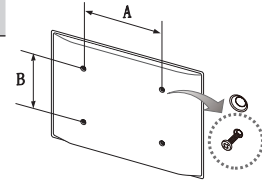

Do not install your Wall Mount Kit while your TV is turned on. It may result in personal injury due to electric shock.

Securing the TV to the Wall



Caution: Pulling, pushing, or climbing onto the TV may cause the TV to fall. In particular, ensure that your children do not hang over or destabilize the TV; doing so may cause the TV to tip over, resulting in serious injuries or death. Follow all safety precautions provided on the included Safety Flyer. For added stability, install the anti-fall device for safety purposes, as follows.



To avoid the TV from falling

1. Put the screws into the clamps and firmly fasten them onto the wall. Confirm that the screws have been firmly installed onto the wall.
 - ✎ You may need additional material, such as an anchor, depending on the type of wall.
 - ✎ Since the necessary clamps, screws, and string are not supplied, please purchase these additionally.
2. Remove the screws from the centre back of the TV, put the screws into the clamps, and then fasten the screws onto the TV again.
 - ✎ Screws may not be supplied with the product. In this case, please purchase the screws of the following specifications.
3. Connect the clamps fixed onto the TV and the clamps fixed onto the wall with a strong string and then tie the string tightly.
 - ✎ **NOTE**
 - Install the TV near to the wall so that it does not fall backwards.
 - It is safe to connect the string so that the clamps fixed on the wall are equal to or lower than the clamps fixed on the TV.
 - Untie the string before moving the TV.
4. Verify that all connections are properly secured. Periodically check connections for any sign of fatigue for failure. If you have any doubt about the security of your connections, contact a professional installer.

Anti-theft Kensington Lock

The Kensington Lock is not supplied by Samsung. It is a device used to physically fix the system when using it in a public place. The appearance and locking method may differ from the illustration, depending on the manufacturer. Refer to the manual provided with the Kensington Lock for additional information on proper use.

To lock the product, follow these steps:

Please find the “” icon on the rear of the TV. A kensington slot is beside the “” icon.

1. Wrap the Kensington lock cable around a large, stationary object such as desk or chair.
2. Slide the end of the cable with the lock attached through the looped end of the Kensington lock cable.
3. Insert the locking device into the Kensington slot on the product (❶).
4. Lock the lock.
 - ✎ These are general instructions. For exact instructions, see the User manual supplied with the locking device.
 - ✎ The locking device has to be purchased separately.
 - ✎ The location of the Kensington Lock may be different depending on the model.

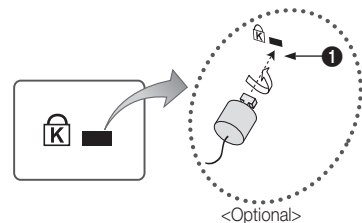



Specifications

Items		Specification	Comment
TV System		DVB-TC, DTMB, PAL, DVB-T2C	
Audio out	Speaker out	40 inch / 48 inch : 10W X 2	
Input	PC	D-sub, Audio-L/R	
	A/V	Audio Video Jack	
	HDMI	Compatible with the HDMI Specifications	
	Antenna	75 ohm Unbalanced, Din Jack , F Jack	
DATA	RJP	RS232	
Operating temperature		10°C ~ 40°C (50°F ~ 104°F)	
Operating Humidity		10% ~ 80%	non-condensing
Storage Temperature		-20°C ~ 45°C (-4°F ~ 113°F)	
Storage Humidity		5% ~ 95%	non-condensing

- Design and specifications are subject to change without prior notice.
- For information about the power supply, and more information about the power consumption, refer to the label attached to the product.
- The above specifications may differ depending on the model.



Supported Video Formats

File Extension	Container	Video Codec	Resolution	Frame rate(fps)	Bit rate(Mbps)	Audio Codec
*.avi / *.mkv *.asf / *.wmv *.mp4 / *.3gp *.vro / *.mpg *.mpeg / *.ts *.tp / *.trp *.mov / *.flv *.vob / *.svi *.divx	AVI	DivX 3.11/4.x/5.x/6.x	1920 x 1080	6-30	30	AC3
	MKV	MPEG4 SP/ASP				LPCM
	ASF	H.264 BP/MP/HP	ADPCM (IMA, MS)			
	MP4	Motion JPEG	8		AAC	
*.vob / *.mpg *.mpeg / *.ts *.tp / *.trp *.mov / *.flv *.vob / *.svi *.divx	3GP	Window Media Video v9	640 x 480	6-30	8	HE-AAC
	MOV	MPEG2				WMA
	FLV	MPEG1	1920 x 1080		30	DD+
	VRO					MPEG (MP3)
VOB	PS TS	1920 x 1080	30	30	DTS (Core)	
PS					G.711(A-Law, μ-Law)	
TS	VP8	VP8	1920 x 1080	30	20	Vorbis
*.webm						WebM

Other Restrictions

- Video content will not play, or not play correctly, if there is an error in the content or the container.
- Sound or video may not work if the contents have a standard bit rate/frame rate above the compatible Frame/sec listed in the table.
- If the Index Table is in error, the Seek (Jump) function is not supported.
- Some USB/digital camera devices may not be compatible with the player.
- The menu can be displayed late if the video is over 10Mbps(bit rate).

Video decoder	Audio decoder
<ul style="list-style-type: none"> • Supports up to H.264, Level 4.1 (FMO/ASO/RS are not supported.) • frame rate : <ul style="list-style-type: none"> - Below 1280 x 720: 60 frame max - Above 1280 x 720: 30 frame max • VC1 AP L4 is not supported. • GMC is not supported. 	<ul style="list-style-type: none"> • WMA 10 Pro supports up to 5.1 channel and M2 profile. • WMA lossless audio is not supported. • Vorbis supports up to 2ch. • DD+ supports up to 5.1 channel.

Supported Subtitle Formats

External

Name	File extension
MPEG-4 timed text	.txt
SAMI	.smi
SubRip	.srt
SubViewer	.sub
Micro DVD	.sub or .txt
SubStation Alpha	.ssa
Advanced SubStation Alpha	.ass
Powerdivx	.psb

Internal

Name	Container	Format
Xsub	AVI	Picture Format
SubStation Alpha	MKV	Text Format
Advanced SubStation Alpha	MKV	Text Format
SubRip	MKV	Text Format
MPEG-4 timed text	MP4	Text Format

Supported Photo Formats

File Extension	Type	Resolution
*.jpg *.jpeg	JPEG	15360 X 8640
*.bmp	BMP	4096 X 4096
*.mpo	MPO	15360 X 8640

Supported Music Formats

File Extension	Type	Codec	Remark
*.mp3	MPEG	MPEG1 Audio Layer 3	
*.m4a *.mpa *.aac	MPEG4	AAC	
*.flac	FLAC	FLAC	Can support up to 2channel
*.ogg	OGG	Vorbis	Can support up to 2channel
*.wma	WMA	WMA	WMA 10 Pro supports up to 5.1 channel and M2 profile. (WMA lossless audio is not supported.)
*.wav	wav	wav	
*.mid *.midi	midi	midi	Can not support seeking



Contact SAMSUNG WORLD WIDE

If you have any questions or comments relating to Samsung products, please contact the SAMSUNG customer care centre.

Country	Customer Care Centre ☎	Web Site
AUSTRIA	0800 - SAMSUNG (0800 - 7267864)	www.samsung.com/at/support
BELGIUM	02-201-24-18	www.samsung.com/be/support (Dutch) www.samsung.com/be_fr/support (French)
BOSNIA	051 331 999	www.samsung.com/support
BULGARIA	07001 33 11 , sharing cost	www.samsung.com/bg/support
CROATIA	062 726 786	www.samsung.com/hr/support
CZECH	800 - SAMSUNG (800-726786) Samsung Electronics Czech and Slovak, s.r.o. V Parku 2343/24, 148 00 - Praha 4	www.samsung.com/cz/support
DENMARK	70 70 19 70	www.samsung.com/dk/support
FINLAND	030-6227 515	www.samsung.com/fi/support
FRANCE	01 48 63 00 00	www.samsung.com/fr/support
GERMANY	0180 6 SAMSUNG bzw. 0180 6 7267864* [HHP] 0180 6 M SAMSUNG bzw. (*0,20 €/Anruf aus dem dt. Festnetz, aus dem Mobilfunk max. 0,60 €/Anruf)	www.samsung.com/de/support
CYPRUS	8009 4000 only from landline, toll free	
GREECE	80111-SAMSUNG (80111 726 7864) only from land line (+30) 210 6897691 from mobile and land line	www.samsung.com/gr/support
HUNGARY	0680SAMSUNG (0680-726-786) 0680PREMIUM (0680-773-648)	http://www.samsung.com/hu/support
ITALIA	800-SAMSUNG (726-7864) [HHP] 800.Msamsung (800.67267864)	www.samsung.com/it/support
LUXEMBURG	261 03 710	www.samsung.com/support
MONTENEGRO	020 405 888	www.samsung.com/support
SLOVENIA	080 697 267 090 726 786	www.samsung.com/si/support
NETHERLANDS	0900-SAMSUNG (0900-7267864) (€ 0,10/Min)	www.samsung.com/nl/support
NORWAY	815 56480	www.samsung.com/no/support
POLAND	0 801-172-678* lub +48 22 607-93-33 ** [HHP] 0 801-672-678* lub +48 22 607-93-33** *(całkowity koszt połączenia jak za 1 impuls według taryfy operatora) ** (koszt połączenia według taryfy operatora)	www.samsung.com/pl/support
PORTUGAL	808 20 7267	www.samsung.com/pt/support
ROMANIA	08008 SAMSUNG (08008 726 7864) TOLL FREE No.	www.samsung.com/ro/support
SERBIA	011 321 6899	www.samsung.com/rs/support
SLOVAKIA	0800 - SAMSUNG (0800-726 786)	www.samsung.com/sk/support
SPAIN	0034902172678 [HHP] 0034902167267	www.samsung.com/es/support
SWEDEN	0771 726 7864 (SAMSUNG)	www.samsung.com/se/support
SWITZERLAND	0848 726 78 64 (0848-SAMSUNG)	www.samsung.com/ch/support (German) www.samsung.com/ch_fr/support (French)
U.K	0330 SAMSUNG (7267864)	www.samsung.com/uk/support
EIRE	0818 717100	www.samsung.com/ie/support
LITHUANIA	8-800-77777	www.samsung.com/lt/support
LATVIA	8000-7267	www.samsung.com/lv/support
ESTONIA	800-7267	www.samsung.com/ee/support
TURKEY	444 77 11	www.samsung.com/tr/support

© 2014 Samsung Electronics Co., Ltd. All rights reserved.